

Welcome to the 2022 catalogue

Dear Customer,

Thank you for your interest in CMT products.

Take a moment to browse our new catalogue and choose from an even wider range of innovative and state-of-the-art woodworking tools, from router bits, saw blades, jig and sabre saw blades, hole saws, and boring bits to oscillating tools, CNC cutters, cutter heads, chucks, power tools, and so much more!

A detailed list of spare parts on each product category is also provided to guide you through your purchase.

We continually strive to develop our technical know-how and make significant investments in research and development, but our greatest priority is customer care. A satisfied customer is worth more than any other achievement; therefore, each page of this catalogue contains CMT's highest commitment to the professional woodworker.

Should you not find a product that suits your needs, please let us know. Our highly skilled engineers and design technicians are always keen to assist you with your woodworking operations.

Thank you for your interest in CMT Orange Tools.

Your CMT Team



OUR CHANNELS



www.cmtorangetools.com

You  Tube



www.youtube.com/user/cmtorangetools



www.facebook.com/cmt.italy



www.instagram.com/cmt_orangetools

Blade Chart Abbreviations

B	= Bore Diameter
D	= Diameter
K	= Kerf Thickness
P	= Plate Thickness
PH	= Pin Hole
PITCH T	= $(D * 3.14) / Z$
RPM	= Round per Minute
T₁	= Workable Thickness
V	= N° of Rakers
Z	= N° of Teeth
α	= Hook Angle
β	= Type of Grind:
ATB	= Alternate Top Bevel Grind
CO / CONICAL	= Conical Teeth
FFT	= Flat Flat Trapezoidal
FLAT / FTG	= Flat Top Grind
FWF	= Flat with Alternate Chamfer
HDF	= Hollow Ground Teeth
Hi-ATB	= High Alternate Top Bevel Grind
HR	= Hollow Back Tooth Configuration
MATB	= Alternate Top Bevel with Chamfer Grind
MTCG	= Triple Chip Grind (Trapezoidal) with Chamfer
TCG	= Triple Chip Grind (Trapezoidal)
BW	= Bevel Alternate (Metal Cutting)
C/HZ	= Double Bevel and Flat (Metal Cutting)
COMBI3	= Pin-Hole 2/7/42 + 2/9/46,4 + 2/10/60
COMBI5	= Pin-Hole 2/7/110 + 2/8,4/130 + 2/14/110 + 4/9/100 + 4/19/120
COMBI7	= Pin-Hole 2/10/80 + 1/11/85 + 2/11/115 + 2/11/148 + 2/14/100 + 2/14/125 + 2/19/120

Chart Abbreviations

α	= Axial Angle
A	= Angle
B	= Bore Diameter
D / D₂ / d	= Diameter
H	= Cutting Depth
l / l₁	= Cutting Length
K	= Thickness
L	= Overall Length
LB	= Relative Length
R / R₁	= Radius
RPM	= Round per Minute
S / S₁	= Shank Diameter
T₁	= Workable Thickness
TPI	= Teeth per Inch
TS	= Tooth Spacing
V	= N° of Spurs
W	= Width
Z	= N° of Teeth
	= Dispatch Package Q.ty

THE RIGHT TOOLS FOR THE BEST RESULTS!

Quick reference charts and pictograms help you choose the right tools for your application.

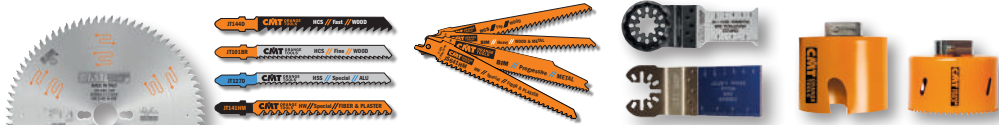

	SAW BLADES	JIG SAW BLADES	SABRE SAW BLADES	MULTI-CUTTERS	HOLE SAWS
WOOD					CARBIDE
WOOD & METAL		✓	✓	✓	
METAL					BI-METAL
ALUMINIUM					
MULTI-MATERIAL					
PLASTIC					
MASONRY					DIAMOND
SPECIAL					

CMT HISTORY

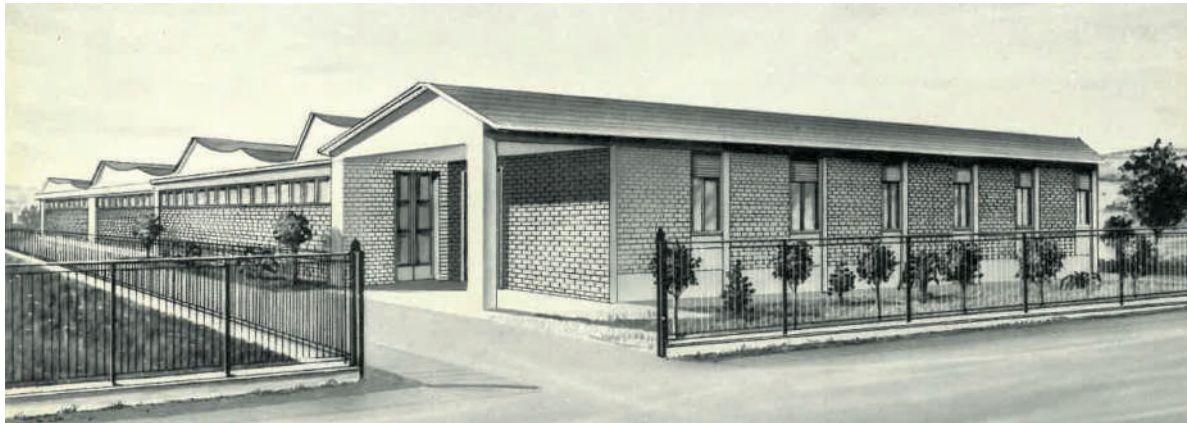
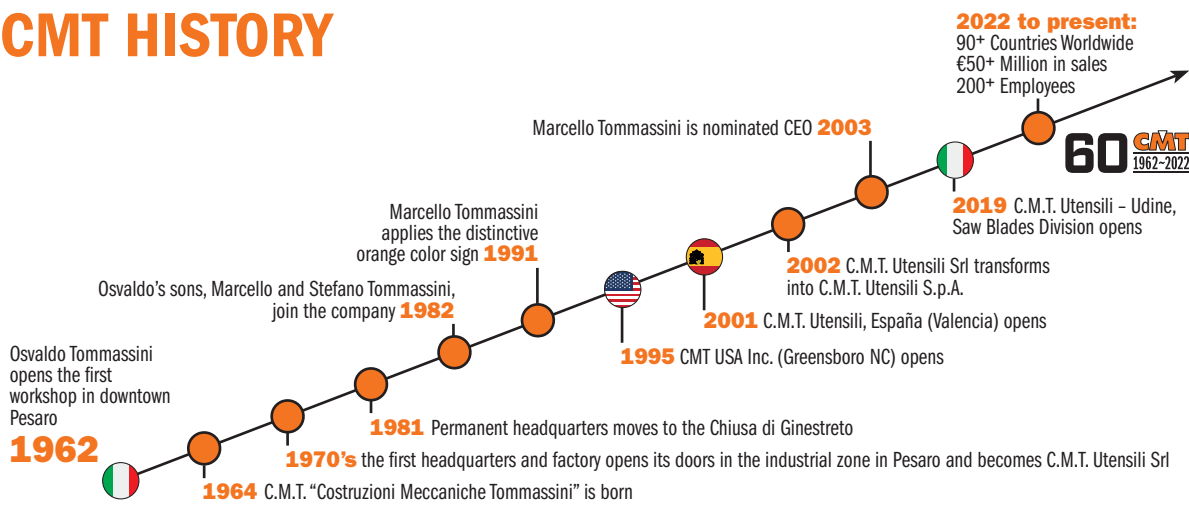

CMT headquarters in the 1970's

CMT LOGO EVOLUTION



Hello there!

My name is **CMT ORANGE TOOLS**, I am the brand name of a dynamic Italian company which I am proud to tell you about. I was born in **1962** thanks to the initiative of my creator and company founder, Osvaldo Tommassini.

By the way, **CMT** stands for Costruzioni Meccaniche Tommassini. Over the years, my appearance has changed significantly.

In **1991** and **1997**, my two brothers (Bit and Blade) were born and following them, many others.

Orange by birth, together we make a great team and are synonymous with quality!

Today, after much hard work, our name has gone global so much so that our photo is registered in Trademark offices around the world.

Present in 90 countries around the world, our family has grown, the result of undying enthusiasm and above all,

the color **ORANGE!**



Our first catalogs

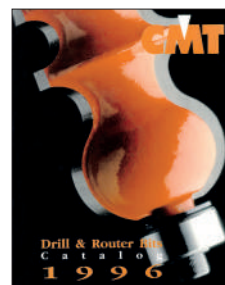

CMT HISTORY & LOGO EVOLUTION



SAW BLADES

4~74



JIG SAW BLADES

75~81



SABRE SAW BLADES

82~94



TOOLS FOR MULTI-CUTTERS

95~120



TOOLS WITH BORE & KNIVES

121~163



ROUTER BITS & SET

164~269



CNC ROUTER CUTTERS & CHUCKS

270~316



INDUSTRIAL DOWEL DRILLS

317~342



BITS FOR HAND POWER TOOLS

343~361



HOLE SAWS

362~375



POWER TOOLS, JIGS & ACCESSORIES

377~411



DISPLAY CABINETS

412~421



SPARE PARTS

422~427

**MADE IN ITALY
SINCE 1962
60 YEARS
AND STILL
GOING STRONG!**

By now, the story has been told. After over 60 years of success and quality in manufacturing wood-working tools - orange woodworking tools, to be precise - word just sort of gets around. We have grown and we have changed, but one thing still remains the same: our commitment to making only the highest quality woodworking tools.



OUR BRANCHES



Pesaro, Italy



Udine, Italy



Greensboro, United States



Valencia, Spain

OUR TOOLS So, what does it take to make a CMT tool? Like all things of quality, it's not only what you do but how you do it. And anyone who works wood knows that you get out of a piece only what you put into it, and it is no different when manufacturing a tool. You choose your designs and materials carefully and you work using all of your skill and know-how. You'll be happy to know that's what we do at CMT too.

OUR TRADEMARK COLOR ORANGE

As the story goes, we began small. We also put orange color surface coating on our tools, then we put our tools on the market and soon our orange tools were all over the world. Now, any woodworker anywhere in the world can tell you that orange tools means CMT, and that CMT means quality. Here at CMT we know we produce quality. You should too. That's why we have trademarked the color orange on woodworking tools - it's your guarantee that you are getting a genuine high-quality CMT product.

DESIGN

Everything starts with a clear idea and having the potential to express it. We have both. At CMT, our technical department uses the best of both worlds - computer technology and hands-on experience - to engineer and design each tool so that it performs flawlessly each time you use it, and to guarantee that you'll be using it for a long, long time.

MATERIALS

Turning a design into a finished product means finding the right material that will do the job and that lives up to the specifications set out in the design - quality performance from the final product depends on it. When it comes to selecting raw materials, we don't cut corners. At CMT, we know that high quality tools come only from high quality raw materials, so we use only solid bar stock steel and specially formulated micrograin carbide to manufacture our bits and blades.



Loading the automated multi-axis CNC sharpening machines.

MANUFACTURING

Like we said, it's not just what you do but how you do it. Over the years we have continuously invested in the latest technology in CNC machining equipment and innovative software to manufacture our tools. The result is that now our entire manufacturing process, from turning and milling the steel shanks to brazing and sharpening the carbide cutting tips, is completely automated. And since a machine is only as intelligent as the person using it, everything is operated by specifically trained operators.

THE FINAL TOUCH

A tool simply wouldn't be a CMT tool if it didn't have the trademark orange color non-stick P.T.F.E. coating on it. This unique industrial strength surface coating is designed to withstand the physical stresses the tool undergoes during use while protecting it from residue build-up and burning. And we really like the orange color too.

QUALITY CONTROL

Nobody's perfect, but we're trying. CMT uses rigorous quality control programs and the latest generation machining equipment to ensure that each bit has been manufactured with precision and accuracy and that it will give the long-lasting performance you expect from a CMT ORANGE TOOL. Our tools are manufactured in compliance with European Standard EN 847 published and enforced by the CEN (European Committee for Standardisation).



WE RECYCLE

CMT filters and purifies its water using a reverse osmosis system located inside the plant. Also the oil used in grinding and machining our tools must be clean and absolutely free of contaminants. Clean oil, after enough use, gets dirty, so we filter and reprocess dirty oil on the premises. This is our way of guaranteeing the quality of the oil we use, as well as contributing to help protect the environment.

LOGISTICS & SERVICES

CMT offers a wide product range with over 7000 different standard tools, but that still isn't enough to achieve 100% customer satisfaction. It's a top priority to process orders and ship the same day. That's why CMT factories worldwide are equipped with 20+ automated vertical storage systems programmed to expedite and simplify order and delivery.

The tools you need, in-stock and ready for prompt shipment within 24 hours. What does this translate to for customers? Quick and efficient service exceeding customer satisfaction and branding our success.



Pesaro, Italy

Greensboro, United States

OUR CHANNELS



www.cmtorangetools.com



www.youtube.com/user/cmtorangetools

















www.facebook.com/cmt.italy





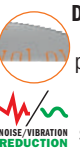







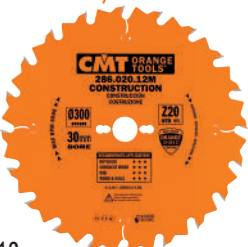

















www.instagram.com/cmt_orangetools

Maximize Your HW Saw's Performance



BLADE RANGE	ORANGE CHROME®	XTREME	INDUSTRIAL		ITK PLUS®
PERFORMANCE	★★★★★	★★★★★	★★★★★	★★★★★	★★★★
					
DESCRIPTION	Designed for professional woodworkers & industrial production requiring high precision and extreme durability in the most challenging applications. Highest possible quality technological market has to offer.		Designed for specialized woodworkers, finish carpenters, construction and industrial users who run their blades all day long demanding precision and extended life, while conquering the most challenging applications.		Designed for the contractor and remodeler who require clean, fast, effortless cuts through wood and wood composite material. The features of the ITK Plus® line offers great price-performance balance which means greater value.
PACKAGING	CARTON BOX + COLORED LABEL		CARTON BOX	CARTON BOX + COLORED LABEL	PLASTIC CLAMSHELL
STEEL PLATE	LASER-CUT PREMIUM QUALITY STEEL PLATE Made of 46-48 HRC precision German steel which is laser-cut to provide tighter tolerances ensuring longer life and more accurate cuts.			HIGH QUALITY LASER-CUT PLATE Strong plate body, laser cut from the finest steel which is then hardened to 44 HRC ensuring longer life and precision cutting.	
CARBIDE TEETH	 INDUSTRIAL CHROMIUM MICROGRAIN CARBIDE Cutting teeth are made from a specially formulated chromium micrograin carbide which stays sharper longer by reducing cutting edge abrasion, improving cut quality and tool life.		 INDUSTRIAL SINTERHIP HI-DENSITY CARBIDE The new process SinterHIP (high temperature 1025°C and high pressure 105 bar) creates a porosity-free and Hi-Density carbide which provides a longer cutting life than traditional carbide.		
KERF	FULL KERF				THIN-KERF
BRAZING	 TRI-METAL BRAZING The Silver-Copper-Silver tri-metal brazing process lets the teeth withstand severe impact caused by cutting harder wood and composite material.		SILVER BRAZING The silver brazing process lets the teeth withstand the standard impact caused by cutting soft wood and composite material.		
COATING	 ORANGE CHROME Blade plate is covered with a chrome layer to protect your tool against corrosion and rust, guaranteeing longer tool life.	HARD LACQUER Protects against corrosion and rust.		 ORANGE SHIELD COATING Keeps the blade running cool, reduces pitch build up and protects against corrosion. Ideal for all types of wood including wet lumber.	
EXPANSION SLOTS	LASER-CUT HEAT EXPANSION SLOTS Engineered to allow the blade to expand when heat build-up occurs from use, preventing blade warping.				
SOUND DAMPENING CHANNELS	 LASER-CUT SLOTS FILLED WITH SOUND-DAMPENING MATERIAL Slots are filled with polyurethane to reduce vibrations and noise (10% less than standard saw blades), improving cut quality and blade life.	LASER-CUT SOUND-DAMPENING CHANNELS Specifically designed to dampen running noise and control wobbling caused by unwanted harmonic vibration.			
TENSIONING RINGS	TENSIONING RING A visible tensioning ring on the blade body provides stability during cut and perfect concentricity during rotation.			×	×
SHARPENING	 PRECISION MIRROR FINISH SHARPENING Each tooth is ground to razor sharp precision on a multi-axis CNC machine which creates perfect edge angle, guaranteeing extra-clean cuts and extended life. Featuring less than 0.25 µm Rmax in edge roughness.		PRECISION FINISH SHARPENING Each tooth is ground to razor sharp precision on a multi-axis CNC machine which creates perfect edge angle, guaranteeing extra-clean cuts and extended life. Featuring less than 0.35 µm Rmax in edge roughness.		 SHEAR ANGLE SHARPENING The shear angle grind on the front face of the teeth allows for smoother cutting, while reducing the required cutting force thereby improving cutting speed and setting a new standard for performance.
BALANCING	 CMT XTREME BALANCING™ This system allows for extremely accurate dynamic balancing of the blade, several orders of magnitude above and beyond that which is currently available in the marketplace.	×	×	×	×

™TRADEMARK & INT. PAT. PEND.

<p>CONSTRUCTION/CONTRACTOR</p>  <p>11-12</p>	<p>MULTI-RIP</p>  <p>13-16</p>	<p>RIPPING</p>  <p>17-19</p>	<p>RIPPING & CROSSCUT</p>  <p>20-23</p>	WOOD
<p>FINISHING</p>  <p>24-27</p>	<p>FINE FINISHING</p>  <p>28-31</p>	<p>ULTRA FINE FINISHING</p>  <p>32-34</p>	<p>ULTRA FINE FINISHING - FRAMES</p>  <p>35</p>	
<p>FINE FINISHING - DOUBLE SIDED</p>  <p>36-37</p>	<p>LAMINATED & CHIPBOARD</p>  <p>38-42,46</p>	<p>PANEL SIZING</p>  <p>43</p>	<p>SCORING</p>  <p>43-46</p>	
<p>DADO</p>  <p>58-59</p>	<p>GROOVING</p>  <p>60-61</p>	<p>GROOVING SYSTEM</p>  <p>62-63</p>	<p>BISCUIT JOINER</p>  <p>62</p>	
<p>NON-FERROUS & PLASTIC</p>  <p>48</p>	<p>NON-FERROUS & MELAMINE</p>  <p>49</p>	<p>NON-FERROUS & MELAMINE</p>  <p>50</p>	<p>NON-FERROUS & MELAMINE</p>  <p>51</p>	NON-FERROUS
<p>HSS - METAL & STEEL</p>  <p>52</p>	<p>HSS - METAL & STEEL</p>  <p>53</p>	<p>METAL & STEEL</p>  <p>54-55</p>	<p>STAINLESS STEEL</p>  <p>56</p>	
<p>DP - ULTRA-HARD MATERIALS</p>  <p>10</p>	<p>DP - MULTI-MATERIALS</p>  <p>47</p>	<p>SOLID SURFACE & PLASTIC</p>  <p>57</p>	<p>CLEARING GRASS, BUSHES, SMALL TREES</p>  <p>63</p>	MULTI MATERIALS

NEW PRODUCTION FACILITY IN UDINE, ITALIA

We are honored to announce the appointment of Piergiorgio Pozzo as Head of the administrative team at our new and highly technological blade production plant based in Udine.

Mr. Pozzo's experience stems from a long-standing commitment to and success in the development of high-performance industrial blades.

Thanks to a rich and extensive knowledge in the field, Mr. Pozzo and his team have successfully patented a brand-new saw blade line of outstanding quality.

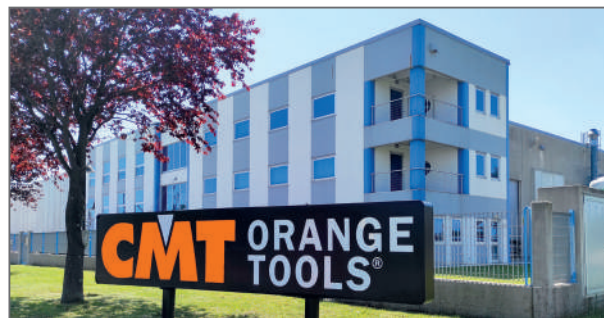

QUALITY ACCORDING TO CMT

Quality can take on different meanings, at times it may relate to the appearance of a product, other times to the number of features or the materials used to make it and so on. Circular saw blades are technical items, tools dedicated to the realization of intermediate workings that if carried out impeccably, enable the manufacturing of the highest-quality finished products with the best production efficiency. Based on this principal, CMT manufactures saw blades using the functional quality concept, this being that every detail of the saw blade, from its design to the choice of materials to its manufacturing cycle, is finalized to give the best performance in the true-life use of the tool. As such, the features of our saw blades are always functional and are found on the product only if and when they bring a true benefit to reaching the established performance target. Should any of the saw blade features fail to do so they will be purposely omitted; the same applies to the tools' manufacturing work cycle which in turn makes it possible for CMT to focus its resources and on what really represents value for the user. The quality embedded in our products is the result of a school of thought which is shared and embraced by the people who make them, and this culture is relentlessly cultivated and improved. Quality at CMT also means respect for people and the Earth.

STEEL PLATE

The body of a blade is an integral part of blade design; cutting quality and longevity depend on it. We use only the highest quality steel available, so durable and tough that it will not only withstand heavy workloads, but also be flexible enough to bend without breaking.

LASER CUT

All our blanks are laser cut; this allows us to use harder harmonic steels for the blade bodies, which in return generates extremely rigid and stable saw blades, guaranteeing perfect flatness. In addition, we are able to engineer quieter tools using a very narrow laser beam to cut expansion and vibration dampening slots.

EXPANSION SLOTS

Unique expansion slots permit the blade to stand up to heat build-up and centrifugal force thereby preventing plate deformation and warping for a cleaner finished cut.

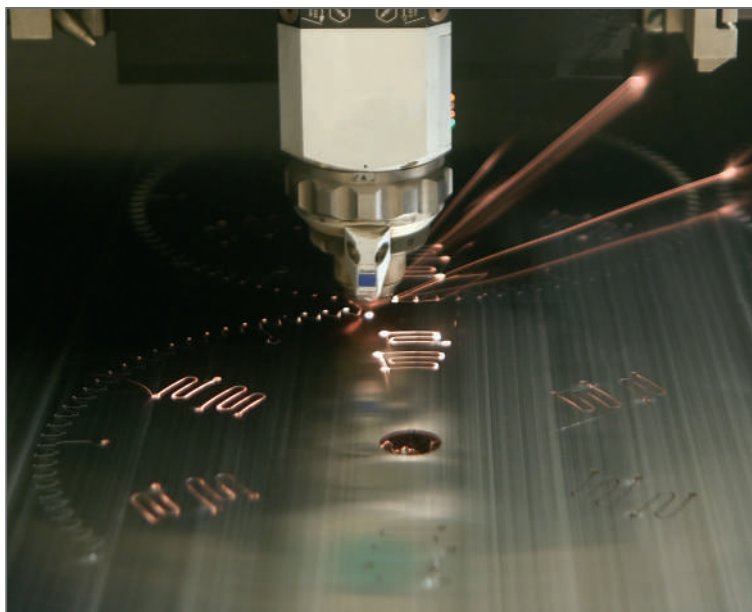

NEW LASER-CUT SLOTS FILLED WITH SOUND-DAMPENING POLYMER

Slots filled with a sound-dampening polymer reducing vibration and noise by 25% with respect to standard saw blades.

Improved cutting quality and extended blade life.

Slots positioned near toothed crown provide impressive vibration isolation and shock absorption.

Fully compliant with National Noise Emission Standard & Regulation.



FILLED SLOTS

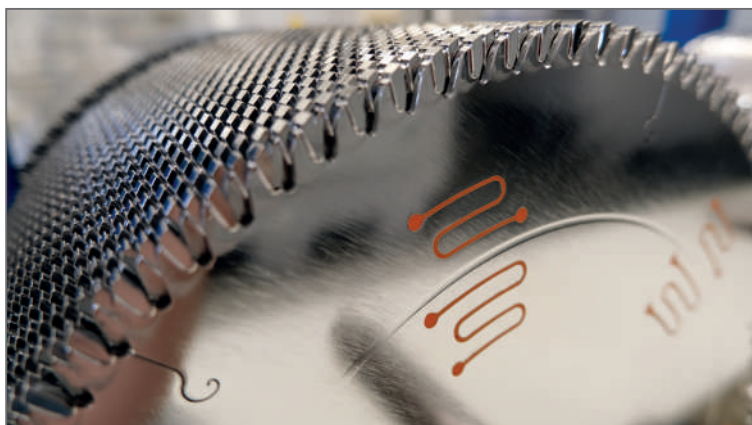

CMT XTREME BALANCING*

* TRADEMARK & INT. PAT. PEND.

This system allows for extremely accurate dynamic balancing of the blade, several orders of magnitude above and beyond that which is currently available in the marketplace.

Each blade undergoes rigorous assessment and only in the event that micro imbalance is detected will the appropriate correction holes be applied.

You may find 1 to 5 micro balancing holes on your blade, depending on the degree of micro imbalance (fig.1). When in perfect balance, a single incision will appear on the blade as proof of balance (fig.2).

These holes will have no effect on the technical properties of the blade during use (such as an increase in noise**, chip build-up at the correction site, etc.).

This translates to precise cutting, longer blade life, reduced vibration and noise, and less wear and tear on your machine components.

**Results are based on tests conducted by an independent laboratory. These results are available for download on our website.

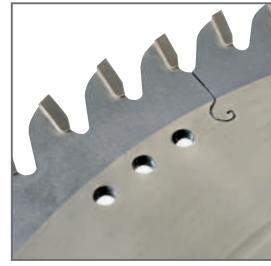
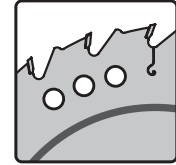

Fig. 1 Example of balancing holes.



Fig. 2 Example of inspected blade already in perfect balance.

**CMT XTREME
BALANCING**



TENSIONING RINGS & FLATTING

To ensure maximum performance, flattening and plate tensioning processes are performed. Every single blade is subject to a flattening process in order to achieve the highest flatness tolerance. The blade body then undergoes tensioning in order to enhance stiffness and stability. A well-marked and visible ring is applied to the blade body by means of compression and with a predetermined force linked to the intended application and working conditions of each blade.

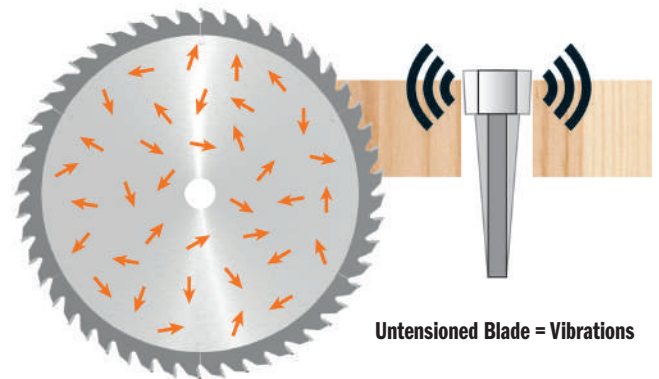
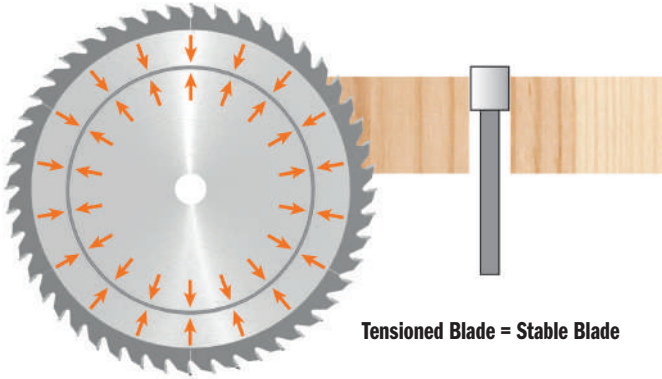

CARBIDE TEETH

Tips require optimum quality carbide. Different applications call for different grades. Our Research and Development Team has evaluated and tested carbide grades and tracked their yield on performance both in house and in the field. We have access to the widest range in the world and only use top premium quality carbides.

TRI-METAL BRAZING

Brazing is the process of attaching a hard metal plate to the steel body of the blade. This is performed by using a bonding metal, which once melted, acts as a binder between the two parts. The bonding material used for brazing is a trimetallic alloy formed by silver, copper and silver, which not only serves to effectively attach the two parts together but whose fundamental properties create a shock-absorber effect protecting the cutting edges during routing operations.

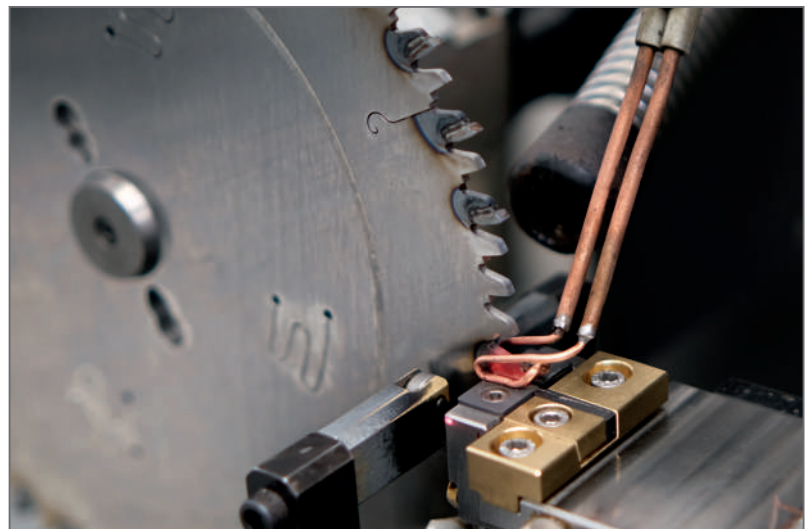
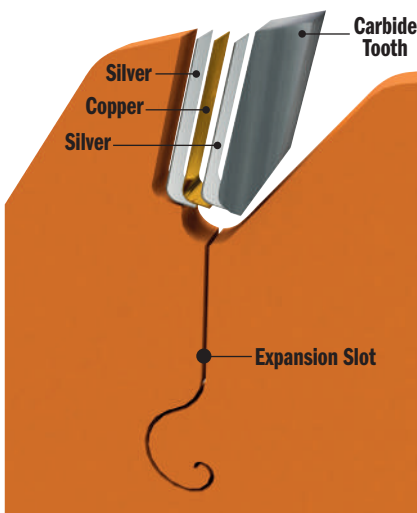

SHARPENING & CUTTING ANGLES

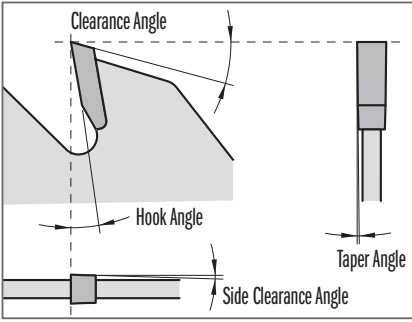

Sharpening is imperative to the production process of the blade and equally important with respect to the project in mind and material in use. Fully automated and numerically controlled grinding machines tooled with extra-fine-grained diamond wheels allow any type of angle and shape of the tooth. The right choice of these parameters will guarantee cutting edge lifetime and ultimately the best finish on the finished part.



COATING

Quality coatings can be extremely effective in certain applications. CMT uses the following:



ORANGE SHIELD COATING: a registered and trademarked non-stick protective coating bearing our characteristic orange color. A technopolymer (P.T.F.E. is spray-applied to the blade body then baked to enhance its protective properties. Chemical compounds cannot attach this coating, it remains insoluble in water and solvents, is completely non-stick and diffuses and disperses heat.



ORANGE CHROME: this is a coating composed of a thin layer of chromium, which is electrolytically deposited on the blade in order to increase wear resistance when in contact with highly abrasive material. Surface hardness increases considerably, guaranteeing long-life and incredible resilience to corrosion and rust.

LASER MARKING & SCREEN PRINTING

All CMT blades are identifiable by means of a latest generation indelible laser marking or multicolored screen-printing, a sophisticated automated technology that guarantees striking and versatile results.

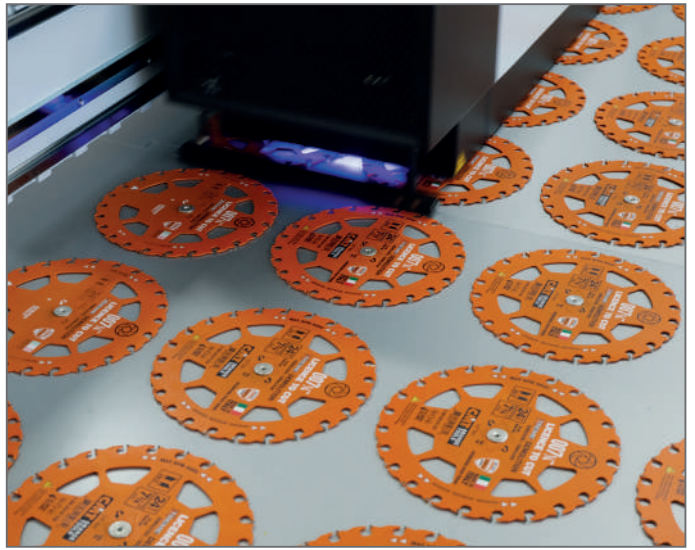

FINAL TESTING AND QUALITY CONTROL

Following design and manufacturing phases, each new model is tested to ensure maximum performance during the work phase. The entire production process is subject to meticulous quality controls using conventional and sophisticated measuring system.



NEW PACKAGING

- Blade packaging is made from strong and sturdy cardboard, reusable and environmentally friendly.
- Package information updated in 12 languages.
- New colored labels offer useful technical information such as application, materials and machine compatibility.



HOW TO CHOOSE A BLADE IN THE NEW CMT CATALOGUE

1

WHAT'S THE MATERIAL YOU WANT TO CUT?

- WOOD**
- NON-FERROUS**
- METAL & STEEL**
- MULTI MATERIALS**

See table on page 5

2

WHAT'S THE APPLICATION?

- RIPPING
- RIPPING & CROSSCUT
- FINISHING
- FINE FINISHING
- ULTRA FINE FINISHING
- etc

See table on page 5

3

WHAT ARE THE PERFORMANCE EXPECTATIONS?



4

WHAT MACHINE ARE YOU USING?

BASED ON YOUR MACHINE, CHOOSE THE APPROPRIATE BLADE:

- DIAMETER (D)
- BORE (B)

SUGGESTIONS FOR CHOOSING THE RIGHT BLADE:

HOOK ANGLE α

- Wood, Solid Surface ($\alpha = 10^\circ \sim 25^\circ$)
- Chipboard, MDF, Plywood, Laminate, Plastic ($\alpha = 5^\circ \sim 15^\circ$)
- Chipboard, MDF, Non-Ferrous, Metals ($\alpha = 0^\circ \sim 10^\circ$)

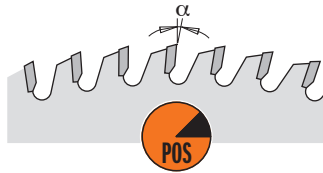

- Metals, Non-Ferrous, Plastic, Laminate ($\alpha = -5^\circ \sim -15^\circ$)

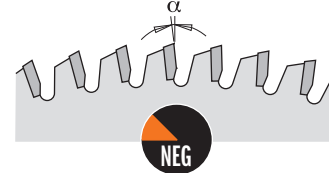

TEETH SHAPE

- Wood, Chipboard, MDF, Plywood

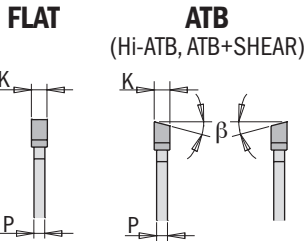

- Laminate, Chipboard, MDF, Plywood, Plastic

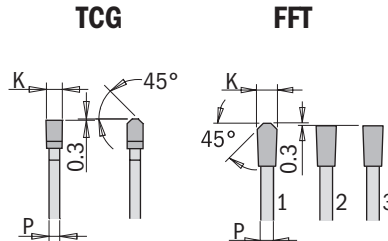

- Metals

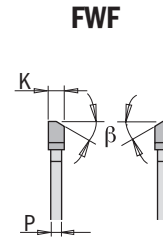

- Special Application/Materials

- HDF**
- FLAT+ATB**
- CO+FLAT**
- MTCG**
- MATB**
- HR**

SUGGESTIONS FOR BLADE USE:

In order to achieve the best cut possible, that is without modifying the predetermined angle of entry/exit, it is important that the portion of the blade (**H**) which extends beyond the workpiece during the cut, be close to equal to the height of an entire tooth (approx. 8/10mm). To improve the finish, it is possible to make small adjustments by increasing or decreasing this height.

The number of teeth simultaneously engaged in cutting the material (**Teeth Cutting or Zp**) must be constant as the thickness of the material varies.

As with $Z_p < 3$, the cutting quality is not guaranteed.

With the same diameter, and when cutting thicker material, ensure to use a blade with less teeth (or with a greater Pitch **P**) or vice versa.

Thin blades are suitable for thinner materials. They also require less power during operation, and are ideal for battery-operated machines.

Thick blades, which are more robust, are suitable for precision cutting in thicker materials but obviously require more power.

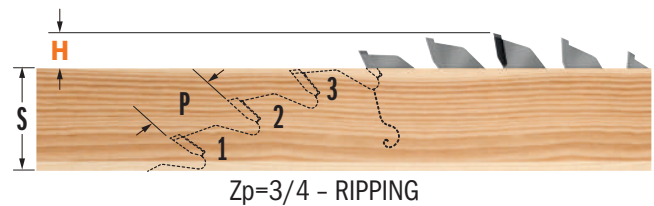

The blade Pitch (**P**), or the distance between each tooth, is calculated in the following way:

$$P = \frac{D \times 3,14}{Z} \quad \begin{matrix} D = \text{Blade Diameter (mm)} \\ Z = N^\circ \text{ of Teeth} \end{matrix}$$

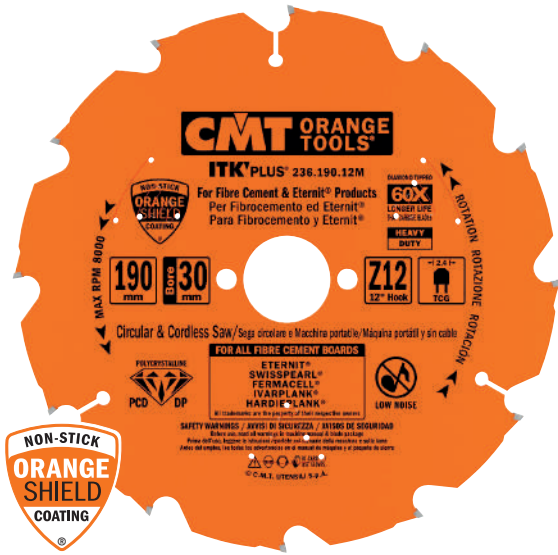

236 ITK PLUS®

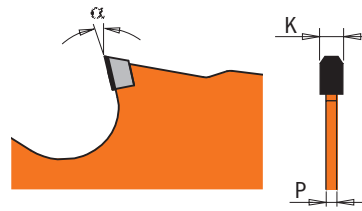

60X
LONGER LIFE
THAN CARBIDE



MULTI-MATERIALS

Machines



MINI CORDLESS CIRC. SAW



CORDLESS CIRCULAR SAW



CIRCULAR SAW



MITRE SAW



RADIAL ARM



TABLE SAW

Blade diameter compatibility is contingent on machine type.

Materials



FIBRE CEMENT



PLASTERBOARD



ETERNIT®

Ideal for:
SWISSPEARL®, FERMACELL®,
IVARPLANK®,
HARDIEPLANK®,
HARDIEPANEL®,
CORIAN®, DUROPLAST®,
FORMICA®

D mm	B mm	PIN HOLE	Z	K mm	P mm	α	β		ORDER NO.
85 *	15	-	6	1,8	1,4	12°	TCG	10	236.085.06G
125 *	22,2	-	7	2,0	1,4	5°	TCG	10	236.125.07
160	20	2/6/32	4	2,4	1,8	12°	TCG	10	236.160.04H
160	20	2/6/32	10	2,4	1,8	5°	TCG	10	236.160.10H
165	20 (+15,87)	2/6/32	4	1,8	1,4	12°	TCG	10	236.165.04H
165	20 (+15,87)	2/6/32	10	1,8	1,4	5°	TCG	10	236.165.10H
180	20	2/6/32	4	2,4	1,8	12°	TCG	10	236.180.04H
190	30	2/7/42	4	2,4	1,8	12°	TCG	10	236.190.04M
190	30	2/7/42	12	2,4	1,8	12°	TCG	10	236.190.12M
210	30	2/7/42	12	2,4	1,8	12°	TCG	10	236.210.12M
216	30	2/7/42	14	2,4	1,8	12°	TCG	10	236.216.14M
230	30	2/7/42	4	2,4	1,8	12°	TCG	10	236.230.04M
250	30	COMBI3	16	2,4	1,8	12°	TCG	10	236.250.16M
300	30	COMBI3	20	2,4	1,8	12°	TCG	5	236.300.20M

*Non-Silent Blades

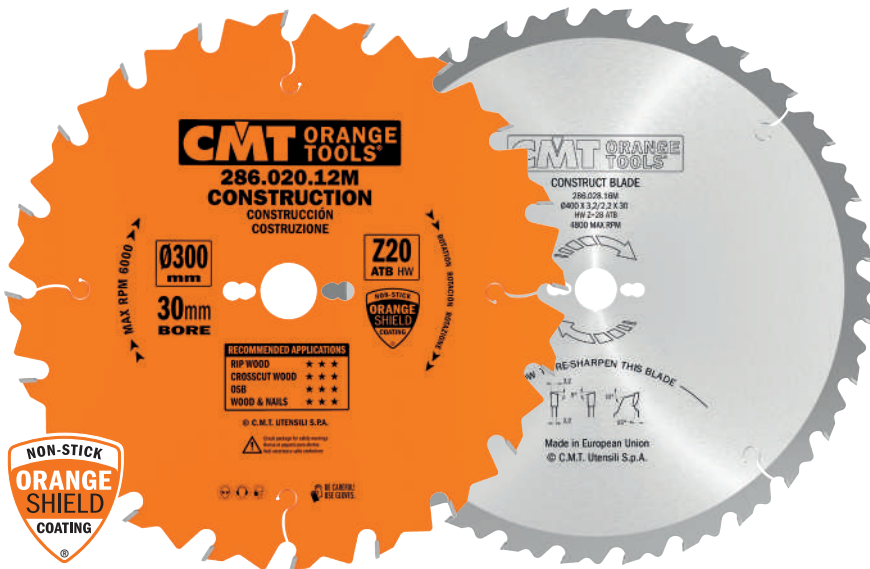

286
CONSTRUCTION



WOOD

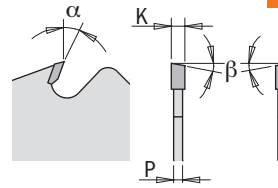

Images are not in scale with each other.

Machines



Blade diameter compatibility is contingent on machine type.

Applications



Materials



NON-STICK ORANGE SHIELD COATING®

D mm	B mm	PIN HOLE	Z	K mm	P mm	α	β	Box	ORDER NO.
250	30	COMBI3	16	2,8	1,8	15°	5° ATB	5	286.016.10M
300	30	COMBI3	20	2,8	1,8	15°	5° ATB	5	286.020.12M
300*	30	COMBI3	48	3,2	2,2	15°	10° ATB	5	286.048.12M
315	30	COMBI3	24	3,2	2,2	15°	5° ATB	5	286.024.13M
350	30	COMBI3	24	3,2	2,2	15°	5° ATB	5	286.024.14M

*Without limiter

D mm	B mm	PIN HOLE	Z	K mm	P mm	α	β	Box	ORDER NO.
400	30	COMBI3	28	3,2	2,2	15°	5° ATB	1	286.028.16M
450	30	2/10/60	32	3,8	2,8	15°	5° ATB	1	286.032.18M
500	30	2/10/60	36	3,8	2,8	15°	5° ATB	1	286.036.20M
550	30	2/10/60	40	4,2	3,2	15°	5° ATB	1	286.040.22M
600	30	2/10/60	40	4,2	3,2	15°	5° ATB	1	286.040.24M
700	30	2/10/60	46	4,4	3,2	15°	5° ATB	1	286.046.28M

SHOP TIPS: Use our reduction ring from 30 to 25mm order n. 299.225.00 (for saw blades Ø250-300-315)
Use our reduction ring from 30 to 25mm order n. 299.228.00 (for saw blades Ø350 and larger)



K CONTRACTOR® CONSTRUCTION



WOOD

Designed for construction, remodeling and DIY projects. These blades deliver performance at a very economical price.

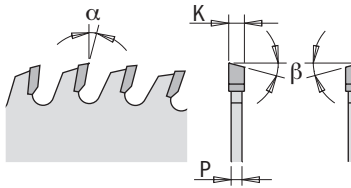

Materials



Applications

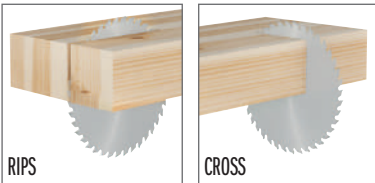

Machines



For specific details regarding applications, please check blade label.

Blade diameter compatibility is contingent on machine type.

DESCRIPTION	PACK	D mm	B mm	PIN HOLE	Z	K mm	P mm	α	β		ORDER NO.
Fine cut-off	CLAMSHELL	85	15		24	1,1	0,7	12°	5° ATB	10	K02403
Crosscut	10 PCS. BULK PACK	136	20		18	1,5	1,0	15°	15° ATB	30	K13618H-X10
Crosscut	10 PCS. BULK PACK	160	20	2/6/32	24	2,2	1,4	15°	15° ATB	30	K16024H-X10
Fine cut-off	10 PCS. BULK PACK	160	20	2/6/32	40	2,2	1,4	10°	15° ATB	30	K16040H-X10
Crosscut	10 PCS. BULK PACK	165	20	2/6/32	24	1,7	1,1	15°	15° ATB	30	K16524H-X10
Crosscut	10 PCS. BULK PACK	190	30	2/7/42	24	2,2	1,4	20°	10° ATB	30	K19024M-X10
Crosscut	10 PCS. BULK PACK	216	30	2/7/42	24	2,4	1,6	-5° Neg.	15° ATB	30	K21624M-X10
Fine cut-off	10 PCS. BULK PACK	216	30	2/7/42	48	2,4	1,6	-5° Neg.	15° ATB	30	K21648M-X10
Crosscut	5 PCS. BULK PACK	250	30	COMBI3	40	2,6	1,8	15°	10° ATB	20	K25040M-X05



Bulk Pack

3-pcs Clamshell Combo Pack

Ø160mm. Bore 20mm

DESCRIPTION	SET CONTAINS	D mm	B mm	PIN HOLE	Z	K mm	P mm	α	β		ORDER NO.
Crosscut	K16024H (1 pc.)	160	20	2/6/32	24	2,2	1,4	15°	15° ATB	10	K160H-X03
Fine cut-off	K16040H (2 pcs.)	160	20	2/6/32	40	2,2	1,4	10°	15° ATB		

3-pcs Clamshell Combo Pack

Ø190mm. Bore 30mm

DESCRIPTION	SET CONTAINS	D mm	B mm	PIN HOLE	Z	K mm	P mm	α	β		ORDER NO.
Crosscut	K19024M (2 pcs.)	190	30	2/7/42	24	2,2	1,4	20°	10° ATB	10	K190M-X03
Fine cut-off	K19040M (1 pc.)	190	30	2/7/42	40	2,2	1,4	15°	10° ATB		



Clamshell Combo Pack

3-pcs Clamshell Combo Pack

Ø216mm. Bore 30mm

DESCRIPTION	SET CONTAINS	D mm	B mm	PIN HOLE	Z	K mm	P mm	α	β		ORDER NO.
Crosscut	K21624M (1 pc.)	216	30	2/7/42	24	2,4	1,6	-5° Neg.	15° ATB	10	K216M-X03
Fine cut-off	K21648M (2 pcs.)	216	30	2/7/42	48	2,4	1,6	-5° Neg.	15° ATB		

2-pcs Clamshell Combo Pack

Ø250mm. Bore 30mm

DESCRIPTION	SET CONTAINS	D mm	B mm	PIN HOLE	Z	K mm	P mm	α	β		ORDER NO.
Rip	K25024M (1 pc.)	250	30	COMBI3	24	2,6	1,8	20°	10° ATB	10	K250M-X02
Crosscut	K25040M (1 pc.)	250	30	COMBI3	40	2,6	1,8	15°	10° ATB		

2-pcs Clamshell Combo Pack

Ø305mm. Bore 30mm

DESCRIPTION	SET CONTAINS	D mm	B mm	PIN HOLE	Z	K mm	P mm	α	β		ORDER NO.
Crosscut	K30540M (1 pc.)	305	30	COMBI3	40	2,8	2,0	-5° Neg.	10° ATB	5	K305M-X02
Fine cut-off	K30560M (1 pc.)	305	30	COMBI3	60	2,8	2,0	-5° Neg.	10° ATB		



279 INDUSTRIAL

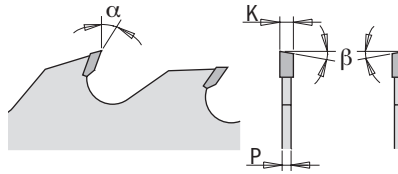

TECHNICAL DETAILS:

The rakers prevent contact between the steel plate body and the material in use.



WOOD

Machines



MULTI-RIP



MOULDERS

Blade diameter compatibility is contingent on machine type.

Applications



MULTI-RIP



Materials



HARDWOOD



SOFTWOOD

D mm	B mm	KEY WAY 	PIN HOLE 	Z+V	K mm	P mm	T ₁ mm	α	β		ORDER NO.
250	30		COMBI3	20+4	3,2	2,2	65	18°	10° ATB	1	279.020.10M
250	70	21 x 5	-	20+4	3,2	2,2	65	18°	10° ATB	1	279.020.10V
250	80	13 x 5	-	20+4	3,2	2,2	65	18°	10° ATB	1	279.020.10W
300	30		COMBI3	24+4	3,2	2,2	80	18°	10° ATB	1	279.024.12M
300	60	21 x 5	-	24+4	3,2	2,2	80	18°	10° ATB	1	279.024.12U
300	70	21 x 5	-	24+4	3,2	2,2	80	18°	10° ATB	1	279.024.12V
300	80	13 x 5	-	24+4	3,2	2,2	80	18°	10° ATB	1	279.024.12W
350	30		COMBI3	28+4	3,5	2,5	105	18°	10° ATB	1	279.028.14M
350	60	21 x 5	-	28+4	3,5	2,5	105	18°	10° ATB	1	279.028.14U
350	70	21 x 5	-	28+4	3,5	2,5	105	18°	10° ATB	1	279.028.14V
350	80	14 x 5	-	28+4	3,5	2,5	105	18°	10° ATB	1	279.028.14W
400	30		COMBI3	28+6	4,0	2,8	120	18°	10° ATB	1	279.028.16M
400	70	21 x 5	-	28+6	4,0	2,8	120	18°	10° ATB	1	279.028.16V

Multi-Rip with Rakers - THIN KERF

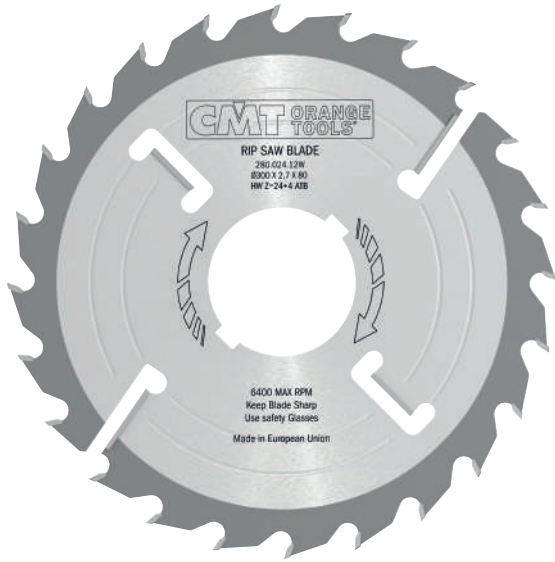

280 INDUSTRIAL

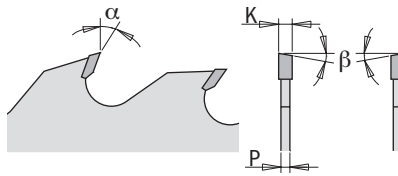

WOOD

TECHNICAL DETAILS:

The rakers prevent contact between the steel plate body and the material in use.

Thin Kerf minimises materials wastes.

Machines





Blade diameter compatibility is contingent on machine type.

Applications



Materials



D mm	B mm	KEY WAY 	Z+V	K mm	P mm	T ₁ mm	α	β		ORDER NO.
180	40		21+3	2,5	1,8	30	18°	FLAT	1	280.021.07S
200	40		21+3	2,5	1,8	35	18°	FLAT	1	280.021.08S
250	70	21 x 5	20+4	2,7	1,8	50	18°	10° ATB	1	280.020.10V
250	80	13 x 5	20+4	2,7	1,8	50	18°	10° ATB	1	280.020.10W
300	70	21 x 5	24+4	2,7	1,8	60	18°	10° ATB	1	280.024.12V
300	80	13 x 5	24+4	2,7	1,8	60	18°	10° ATB	1	280.024.12W

277 INDUSTRIAL



WOOD

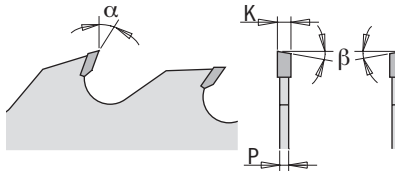

TECHNICAL DETAILS:

The rakers prevent contact between the steel plate body and the material in use.

Mounted on the sides of gang rip saws, these act as shoulder saw blades and ensure stability, reducing vibration under extreme work load.



Machines



MULTI-RIP

Applications



MULTI-RIP



Materials



HARDWOOD



SOFTWOOD

D mm	B mm	KEY WAY 	PIN HOLE 	Z+V	K mm	P mm	T ₁ mm	α	β		ORDER NO.
300	30		COMBI3	24+4	4,0	2,8	80	18°	10° ATB	1	277.024.12M
300	70	21 x 5	-	24+4	4,0	2,8	80	18°	10° ATB	1	277.024.12V
300	80	13 x 5	-	24+4	4,0	2,8	80	18°	10° ATB	1	277.024.12W
350	30		COMBI3	24+6	4,2	2,8	105	18°	10° ATB	1	277.024.14M
350	70	21 x 5	-	24+6	4,2	2,8	105	18°	10° ATB	1	277.024.14V



278 INDUSTRIAL

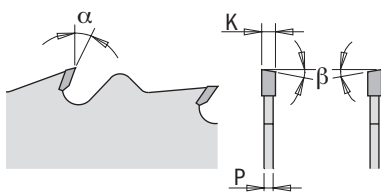

WOOD

Machines



SQUARING



MULTI-RIP

Blade diameter compatibility is contingent on machine type.

Applications



MULTI-RIP



RIPS



Materials



HARDWOOD



SOFTWOOD

D mm	B mm	KEY WAY 	PIN HOLE 	Z	K mm	P mm		α	β		ORDER NO.
300	30		COMBI3	28	3,2	2,2		18°	10° ATB	1	278.028.12M
300	70	21 x 5	-	28	3,2	2,2		18°	10° ATB	1	278.028.12V
350	30		COMBI3	36	3,5	2,5		18°	10° ATB	1	278.036.14M
350	70	21 x 5	-	36	3,5	2,5		18°	10° ATB	1	278.036.14V

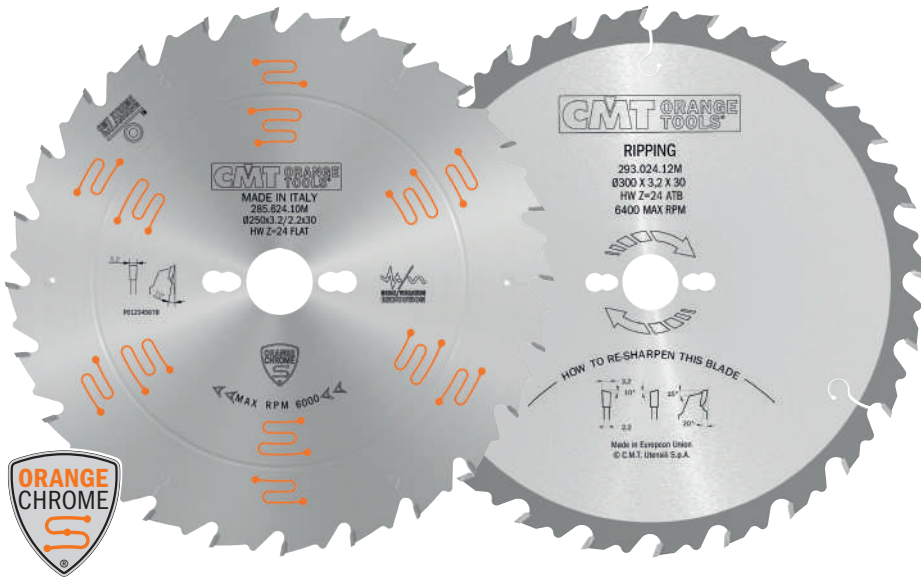

285-293



WOOD

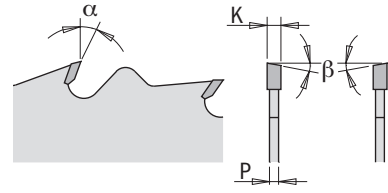

Images are not in scale with each other.



Machines



Blade diameter compatibility is contingent on machine type.

Applications



Materials



285 ORANGE CHROME®



PERFORMANCE

D mm	B mm	PIN HOLE	Z	K mm	P mm	α	β	Box	ORDER NO.
250	30	COMBI3	24	3,2	2,2	10°	FLAT	5	285.624.10M

285-293 INDUSTRIAL



PERFORMANCE

D mm	B mm	PIN HOLE	Z	K mm	P mm	α	β	Box	ORDER NO.
300	30	COMBI3	24	3,2	2,2	20°	10° ATB	1	293.024.12M
300	35	-	24	3,2	2,2	20°	10° ATB	1	293.024.12R
305	30	2/10/60	28	2,8	1,8	20°	10° ATB	1	293.028.22M
315	30	COMBI3	28	3,2	2,2	20°	10° ATB	1	293.028.12M
315	30	COMBI3	36	3,2	2,2	15°	5° ATB	1	285.036.13M
350	30	COMBI3	28	3,5	2,5	20°	10° ATB	1	293.028.14M
350	35	-	28	3,5	2,5	20°	10° ATB	1	293.028.14R
400	30	COMBI3	36	3,5	2,5	20°	10° ATB	1	285.036.16M
450	30	COMBI3	36	3,8	2,8	20°	10° ATB	1	285.036.18M
500	30	COMBI3	44	4,0	2,8	20°	10° ATB	1	285.044.20M



290 INDUSTRIAL

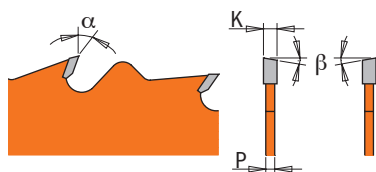

PERFORMANCE

WOOD

Machines

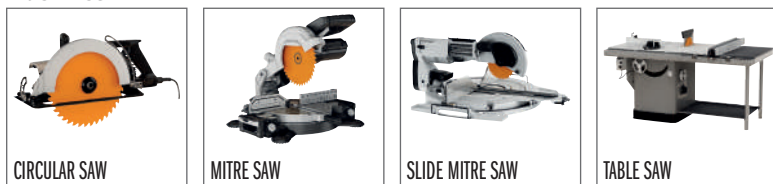

CIRCULAR SAW

MITRE SAW

SLIDE MITRE SAW

TABLE SAW

Blade diameter compatibility is contingent on machine type.

Applications



RIP

Materials



HARDWOOD

SOFTWOOD

OSB

D mm	B mm	PIN HOLE 	Z	K mm	P mm	α	β		ORDER NO.
150	20	-	12	2,4	1,4	20°	10° ATB	10	290.150.12H
160	16	-	12	2,2	1,6	20°	10° ATB	5	290.160.12E ■
160	20 (+16)	2/6/32	12	2,2	1,6	20°	10° ATB	10	290.160.12H ●
180	30	2/7/42	12	2,6	1,6	20°	10° ATB	10	290.180.12M
190	16	2/6/32	12	2,6	1,6	20°	10° ATB	5	290.190.12E ■
190	20	2/6/32	12	2,6	1,6	20°	10° ATB	5	290.190.12H ■
190	30 (+20+16)	2/7/42	12	2,6	1,6	20°	10° ATB	10	290.190.12M
200	30	2/7/42	24	2,8	1,8	20°	10° ATB	10	290.200.24M
210	30	2/7/42	24	2,8	1,8	20°	10° ATB	10	290.210.24M ●
216	30	2/7/42	24	2,8	1,8	-5° Neg.	15° ATB	10	290.216.24M ●
220	30	2/7/42	24	2,8	1,8	20°	10° ATB	10	290.220.24M
230	30	2/7/42	24	2,8	1,8	20°	10° ATB	10	290.230.24M ●
235	25	-	24	2,8	1,8	20°	10° ATB	5	290.235.24L ■
235	30 (+25)	2/7/42	24	2,8	1,8	20°	10° ATB	10	290.235.24M
240	30	2/7/42	24	2,8	1,8	20°	10° ATB	10	290.240.24M
250	30	COMBI3	24	2,8	1,8	20°	10° ATB	5	290.250.24M
260	30	COMBI3	28	2,8	1,8	20°	10° ATB	5	290.260.28M ●
270	30	COMBI3	28	2,8	1,8	20°	10° ATB	5	290.270.28M

● Ideal for FESTOOL®

■ Until stock last



271 ITK PLUS®

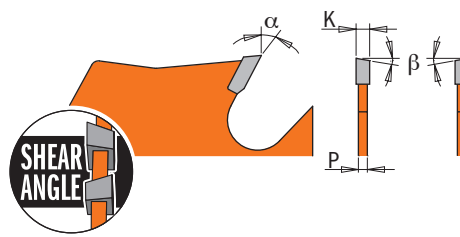

HW

★ ★ ★ ★ ★
PERFORMANCE

WOOD

Machines



Blade diameter compatibility is contingent on machine type.

Applications



Materials



D mm	B mm	PIN HOLE	Z	K mm	P mm	α	β		ORDER NO.
250	30	COMBI3	24	2,4	1,6	20°	10° ATB + 8° Shear	10	271.250.24M
300	30	COMBI3	24	2,6	1,8	22°	10° ATB + 8° Shear	5	271.300.24M

Ripping & Crosscut [General Purpose]

285.6 ORANGE CHROME®



PERFORMANCE

WOOD

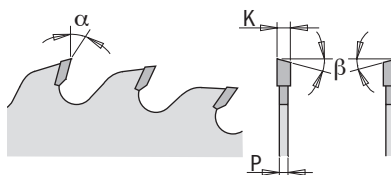

Machines



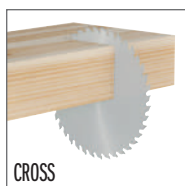

Blade diameter compatibility is contingent on machine type.

Applications



Materials



D mm	B mm	PIN HOLE 	Z	K mm	P mm	α	β		ORDER NO.
250	30	COMBI3	40	3,2	2,2	15°	10° ATB	5	285.640.10M
300	30	COMBI3	48	3,2	2,2	15°	10° ATB	5	285.648.12M
350	30	COMBI3	54	3,5	2,5	15°	10° ATB	3	285.654.14M
400	30	COMBI3	60	3,5	2,5	10°	15° ATB	2	285.660.16M

285-294 INDUSTRIAL



WOOD

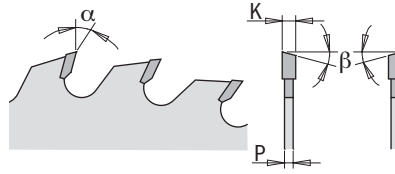

Machines



Blade diameter compatibility is contingent on machine type.

Applications

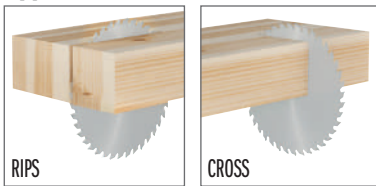

Materials

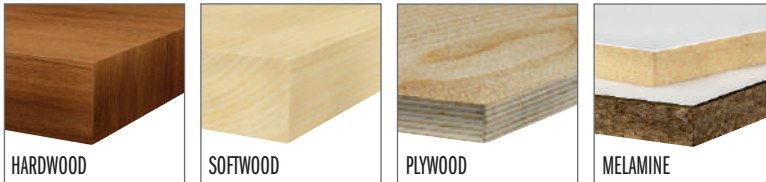

D mm	B mm	PIN HOLE ⊕⊗⊕	Z	K mm	P mm	α	β		ORDER NO.
250*	20	-	40	3,2	2,2	15°	10° ATB	1	285.040.10H
250	30	COMBI3	40	3,2	2,2	15°	10° ATB	1	285.040.10M
250	35	-	40	3,2	2,2	15°	10° ATB	1	285.040.10R
250	30	COMBI3	48	3,2	2,2	15°	10° ATB	1	285.048.10M
254	30	COMBI3	48	2,4	1,8	-5° Neg.	15° ATB	1	294.048.10M
275	20	-	42	3,2	2,2	15°	10° ATB	1	285.042.11H
300	30	COMBI3	36	3,2	2,2	15°	10° ATB	1	285.036.12M
300*	20	COMBI3	48	3,2	2,2	15°	10° ATB	1	285.048.12H
300	30	COMBI3	48	3,2	2,2	15°	10° ATB	1	285.048.12M
300	35	-	48	3,2	2,2	15°	10° ATB	1	285.048.12R
305	30	2/10/60 + 2/7/42	54	2,8	1,8	-5° Neg.	15° ATB	1	294.054.22M
315*	30	COMBI3	54	3,2	2,2	15°	10° ATB	1	294.054.12M
350	30	COMBI3	54	3,5	2,5	15°	10° ATB	1	285.054.14M
350	35	-	54	3,5	2,5	15°	10° ATB	1	285.054.14R
400	30	COMBI3	48	3,5	2,5	20°	10° ATB	1	285.048.16M
450	30	COMBI3	54	3,8	2,8	15°	15° ATB	1	285.054.18M
500	30	2/10/60	60	3,8	2,8	15°	15° ATB	1	285.060.20M
550	30	2/10/60	60	4,2	3,2	10°	15° ATB	1	285.060.22M
600	30	2/10/60	66	4,2	3,2	10°	15° ATB	1	285.066.24M
700	30	2/10/60	72	4,4	3,2	10°	15° ATB	1	285.072.28M

*Non-Silent Blades



285-291 INDUSTRIAL



WOOD

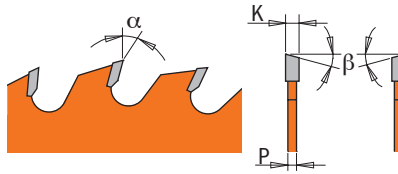

Machines



Blade diameter compatibility is contingent on machine type.

Applications

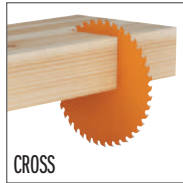

Materials

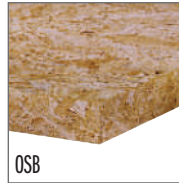

D mm	B mm	PIN HOLE	Z	K mm	P mm	α	β	APPLICATIONS	📦	ORDER NO.
120	20	2/5,5/30	18	1,8	1,2	15°	15° ATB	General Purpose	10	291.120.18H
125	20	-	20	2,4	1,4	15°	15° ATB	General Purpose	10	291.125.20H
130	20	-	20	2,4	1,4	15°	15° ATB	General Purpose	10	291.130.20H
140	20	-	20	2,4	1,4	15°	15° ATB	General Purpose	10	291.140.20H
150	16	-	24	2,4	1,4	15°	15° ATB	General Purpose	5	291.150.24E ■
150	20(+16)	-	24	2,4	1,4	15°	15° ATB	General Purpose	10	291.150.24H
160	20	2/6/32	24	2,2	1,6	15°	15° ATB	General Purpose	10	291.160.24H ●
160	20	2/6/32	28	2,2	1,6	15°	10° ATB	General Purpose	10	285.160.28H ⚠️
160	30(+16)	2/7/42	24	2,2	1,6	15°	15° ATB	General Purpose	10	291.160.24M
165	20	2/6/32	24	2,2	1,6	15°	15° ATB	General Purpose	10	291.165.24H
165	30	2/7/42	24	2,6	1,6	15°	15° ATB	General Purpose	10	291.165.24M
170	30	2/7/42	24	2,6	1,6	20°	10° ATB	General Purpose	10	291.170.24M
180	20	2/6/32	24	2,6	1,6	20°	10° ATB	General Purpose	10	291.180.24H
180	30	2/7/42	24	2,6	1,6	20°	10° ATB	General Purpose	10	291.180.24M
184	16	-	24	2,6	1,6	20°	10° ATB	General Purpose	10	291.184.24E
184	30	-	24	2,6	1,6	20°	10° ATB	General Purpose	10	291.184.24M
190	16	2/6/32	24	2,6	1,6	20°	10° ATB	General Purpose	10	291.190.24E
190	20	2/6/32	24	2,6	1,6	20°	10° ATB	General Purpose	10	291.190.24H
190	30	2/7/42	24	2,6	1,6	20°	10° ATB	General Purpose	10	291.190.24M
190	20 (FESTOOL® FF)	Key 5/7/2,5	32	2,6	1,8	10°	10° ATB	General Purpose	10	291.190.32FF ●
200	30	2/7/42	36	2,8	1,8	15°	15° ATB	General Purpose	10	291.200.36M
200	30	COMBI3	36	3,2	2,2	15°	10° ATB	General Purpose	10	285.036.08M ⚠️
210	25	-	36	2,8	1,8	15°	15° ATB	General Purpose	5	291.210.36L ■
210	30	2/7/42	36	2,8	1,8	15°	15° ATB	General Purpose	10	291.210.36M ●
216	30	2/7/42	48	2,8	1,8	-5° Neg.	15° ATB	Finish	10	291.216.48M ●
220	30	2/7/42	36	2,8	1,8	15°	15° ATB	General Purpose	10	291.220.36M
225	30	2/7/42	36	2,8	1,8	20°	15° ATB	General Purpose	10	291.225.36M ●
230	30	2/7/42	36	2,8	1,8	15°	15° ATB	General Purpose	10	291.230.36M ●
235	25	-	36	2,8	1,8	15°	15° ATB	General Purpose	5	291.235.36L ■
235	30	2/7/42	36	2,8	1,8	15°	15° ATB	General Purpose	10	291.235.36M
240	30	2/7/42	36	2,8	1,8	15°	15° ATB	General Purpose	10	291.240.36M
260	30	COMBI3	48	2,8	1,8	15°	10° ATB	General Purpose	5	285.048.11M ●
270	30	COMBI3	42	2,8	1,8	15°	10° ATB	General Purpose	5	291.270.42M

● Ideal for FESTOOL®

■ Until stock last

271 ITK^{PLUS}



WOOD

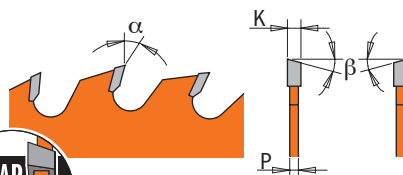
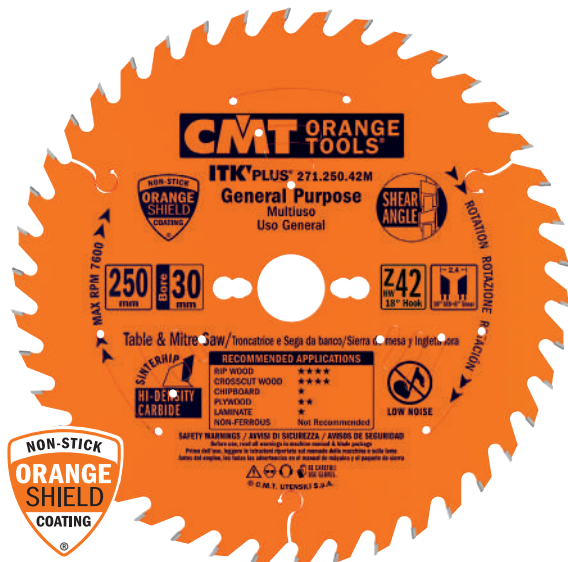

Machines



Blade diameter compatibility is contingent on machine type.

Applications

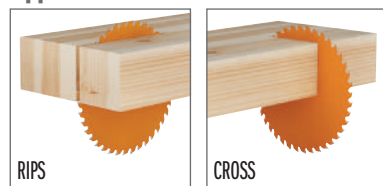

Materials



D mm	B mm	PIN HOLE ⊕⊖⊕	Z	K mm	P mm	α	β		ORDER NO.
136	20 (+10)	-	18	1,5	1,0	20°	10° ATB + 8° Shear	10	271.136.18H
140	20	2/6/32,5	24	1,8	1,2	15°	15° ATB + 8° Shear	10	271.140.24H
150	20 (+16)	-	24	1,5	1,0	18°	10° ATB + 8° Shear	10	271.150.24H
160	20 (+16)	2/6/32	24	1,8	1,2	18°	10° ATB + 8° Shear	10	271.160.24H
165	20 (+15,87)	2/6/32	24	1,7	1,1	18°	10° ATB + 8° Shear	10	271.165.24H
165	30	2/7/42	24	1,7	1,1	18°	10° ATB + 8° Shear	10	271.165.24M
184	20 (+16+15,87)	2/7/42	24	1,7	1,1	20°	10° ATB + 8° Shear	10	271.184.24H
184	30	2/7/42	24	1,7	1,1	20°	10° ATB + 8° Shear	10	271.184.24M
190	30 (+20+16)	2/7/42	24	1,7	1,1	20°	10° ATB + 8° Shear	10	271.190.24M
200	30	2/7/42	36	1,8	1,2	15°	10° ATB + 8° Shear	10	271.200.36M
210	30 (+25)	2/7/42	24	1,8	1,2	20°	10° ATB + 8° Shear	10	271.210.24M
210	30 (+25)	2/7/42	36	1,8	1,2	15°	10° ATB + 8° Shear	10	271.210.36M
216	30	2/7/42	36	1,8	1,2	-5° Neg.	10° ATB + 8° Shear	10	271.216.36M
235	25	-	36	1,7	1,2	20°	1 FLAT+2/15° ATB	10	271.235.36L ■
235	30 (+25)	2/7/42	36	2,4	1,6	18°	10° ATB + 8° Shear	10	271.235.36M
250	30	COMBI3	42	2,4	1,6	18°	10° ATB + 8° Shear	10	271.250.42M
300	30	COMBI3	48	2,6	1,8	18°	10° ATB + 8° Shear	5	271.300.48M
305	30	COMBI3	48	2,6	1,8	-5° Neg.	10° ATB	5	271.305.48M

■ Until stock last



285 ORANGE CHROME®



WOOD

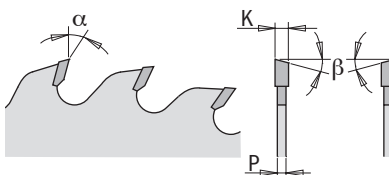

Machines

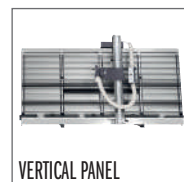

Blade diameter compatibility is contingent on machine type.

Applications



Materials

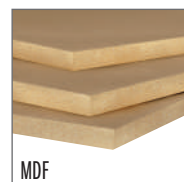

For specific details regarding suggested materials, please check blade label.

D mm	B mm	PIN HOLE 	Z	K mm	P mm	α	β		ORDER NO.
216	30	2/7/42	48	2,3	1,6	-5° Neg.	15° ATB	5	285.816.48M ●
250	30	COMBI3	60	3,2	2,2	10°	15° ATB	5	285.660.10M
260	30	COMBI3	60	2,5	1,8	-5° Neg.	10° ATB	5	285.860.11M ●
300	30	COMBI3	72	3,2	2,2	10°	15° ATB	5	285.672.12M
350	30	COMBI3	84	3,5	2,5	10°	15° ATB	3	285.684.14M
400	30	COMBI3	96	3,5	2,5	10°	15° ATB	2	285.696.16M

● Ideal for FESTOOL®

285-294-295 INDUSTRIAL



WOOD

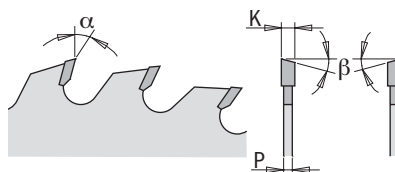

Machines



MITRE SAW



SLIDE MITRE SAW



RADIAL ARM



TABLE SAW

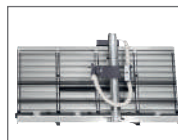

VERTICAL PANEL

Blade diameter compatibility is contingent on machine type.

Applications



Materials

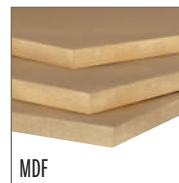

D mm	B mm	PIN HOLE 	Z	K mm	P mm	α	β		ORDER NO.
250	30	COMBI3	60	3,2	2,2	10°	15° ATB	1	285.060.10M
250	35	-	60	3,2	2,2	10°	15° ATB	1	285.060.10R
254	30	COMBI3	60	2,4	1,8	-5° Neg.	15° ATB	1	294.060.10M
280*	30	COMBI3	64	2,8	1,8	10°	15° ATB	1	295.064.11M
300	30	COMBI3	60	3,2	2,2	15°	10° ATB	1	285.060.12M
300	30	COMBI3	72	3,2	2,2	10°	15° ATB	1	285.072.12M
300	35	-	72	3,2	2,2	10°	15° ATB	1	285.072.12R
305	30	COMBI3	72	3,2	2,2	10°	15° ATB	1	285.072.22M
305	30	COMBI3	72	3,2	2,2	-5° Neg.	15° ATB	1	294.072.22M
315	30	COMBI3	72	3,2	2,2	15°	10° ATB	1	285.072.13M
350	30	COMBI3	72	3,5	2,5	15°	10° ATB	1	285.072.14M
350	30	COMBI3	84	3,5	2,5	10°	15° ATB	1	285.084.14M
350	35	-	84	3,5	2,5	10°	15° ATB	1	285.084.14R
400	30	COMBI3	60	3,5	2,5	10°	15° ATB	1	285.060.16M
450	30	COMBI3	66	3,8	2,8	10°	15° ATB	1	285.066.18M
500	30	2/10/60	72	3,8	2,8	10°	15° ATB	1	285.072.20M
550	30	2/10/60	96	4,2	3,2	10°	15° ATB	1	285.096.22M

*Non-Silent Blades

285-292-294 INDUSTRIAL



WOOD

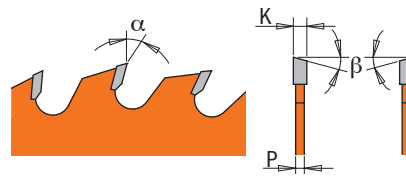

Machines



Blade diameter compatibility is contingent on machine type.

Applications



Materials

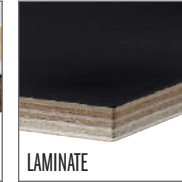

D mm	B mm	PIN HOLE	Z	K mm	P mm	α	β	APPLICATIONS		ORDER NO.
120	20	2/5,5/30	40	1,8	1,2	10°	15° ATB	Fine Finish	10	292.120.40H
125	20	-	36	2,4	1,4	15°	15° ATB	Fine Finish	10	292.125.36H
130	20	-	36	2,4	1,4	15°	15° ATB	Fine Finish	10	292.130.36H
140	20	-	36	2,4	1,4	15°	15° ATB	Fine Finish	10	292.140.36H
150	20	-	40	2,4	1,4	15°	15° ATB	Fine Finish	10	292.150.40H
150	30	2/7/42	48	3,2	2,2	5°	15° ATB	Fine Finish	10	285.048.06M
160	20	2/6/32	40	2,2	1,6	10°	15° ATB	Finish	10	292.160.40H ●
160	30	2/7/42	40	2,2	1,6	10°	15° ATB	Finish	10	292.160.40M
160	20	2/6/32	48	2,2	1,6	5°	15° ATB	Fine Finish	10	285.160.48H ●
165	20	2/6/32	40	2,2	1,6	10°	15° ATB	Finish	10	292.165.40H
165	30	2/7/42	40	2,6	1,6	10°	15° ATB	Finish	10	292.165.40M
170	30	2/7/42	40	2,6	1,6	15°	15° ATB	Finish	10	292.170.40M
180	20	2/6/32	40	2,6	1,6	15°	15° ATB	Finish	10	292.180.40H
180	30	2/7/42	40	2,6	1,6	15°	15° ATB	Finish	10	292.180.40M
180	30	2/7/42	56	3,2	2,2	5°	15° ATB	Fine Finish	10	285.056.07M
184	16	-	40	2,6	1,6	15°	15° ATB	Finish	10	292.184.40E
184	30	-	40	2,6	1,6	15°	15° ATB	Finish	10	292.184.40M
190	20 (+16)	2/6/32	40	2,6	1,6	15°	15° ATB	Finish	10	292.190.40H
190	30	2/7/42	40	2,6	1,6	15°	15° ATB	Finish	10	292.190.40M
190	20 (FESTOOL® FF)	Key 5/7/2,5	48	2,4	1,8	10°	15° ATB	Fine Finish	10	292.190.48FF ●
200	30	2/7/42	48	2,8	1,8	15°	15° ATB	Finish	10	292.200.48M
200	30	COMBI3	48	3,2	2,2	15°	15° ATB	Finish	10	285.048.08M
210	25	-	48	2,8	1,8	15°	15° ATB	Finish	5	292.210.48L ■
210	30	2/7/42	48	2,8	1,8	15°	15° ATB	Finish	10	292.210.48M ●
216	30	2/7/42	64	2,8	1,8	-5° Neg.	15° ATB	Fine Finish	10	292.216.64M ●
220	30	2/7/42	48	2,8	1,8	15°	15° ATB	Finish	10	292.220.48M
225	30	2/7/42	48	2,8	1,8	10°	15° ATB	Finish	10	292.225.48M ●
230	30	2/7/42	48	2,8	1,8	15°	15° ATB	Finish	10	292.230.48M ●
235	25	-	48	2,8	1,8	15°	15° ATB	Finish	5	292.235.48L ■
235	30	2/7/42	48	2,8	1,8	15°	15° ATB	Finish	10	292.235.48M
240	30	2/7/42	48	2,8	1,8	15°	15° ATB	Finish	10	292.240.48M
260	30	COMBI3	60	2,8	1,8	10°	15° ATB	Finish	5	285.060.11M ●
260	30	COMBI3	60	2,5	1,8	-5° Neg.	15° ATB	Finish	5	294.060.11M ●

● Ideal for FESTOOL®

■ Until stock last



272 ITK PLUS®



WOOD

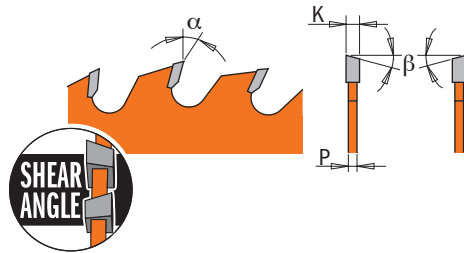

Machines



Blade diameter compatibility is contingent on machine type.

Applications



Materials



D mm	B mm	PIN HOLE ⊕⊗⊕	Z	K mm	P mm	α	β		ORDER NO.
115	9,5	-	24	1,5	1,0	20°	10° ATB + 8° Shear	10	272.115.24
136	20 (+10)	-	36	1,5	1,0	18°	10° ATB + 8° Shear	10	272.136.36H
140	20	2/6/32,5	42	1,8	1,2	5°	15° ATB + 8° Shear	10	272.140.42H
150	20 (+16)	-	40	1,5	1,0	16°	10° ATB + 8° Shear	10	272.150.40H
160	20 (+16)	2/6/32	40	1,8	1,2	16°	10° ATB + 8° Shear	10	272.160.40H
165	20 (+15,87)	2/6/32	36	1,7	1,1	20°	10° ATB + 8° Shear	10	272.165.36H
184	20 (+16+15,87)	2/7/42	40	1,7	1,1	18°	10° ATB + 8° Shear	10	272.184.40H
184	30	2/7/42	40	1,7	1,1	18°	10° ATB + 8° Shear	10	272.184.40M
190	30 (+20+16)	2/7/42	42	1,7	1,1	18°	10° ATB + 8° Shear	10	272.190.42M
200	30	2/7/42	48	1,8	1,2	15°	10° ATB + 8° Shear	10	272.200.48M
210	30 (+25)	2/7/42	48	1,8	1,2	15°	10° ATB + 8° Shear	10	272.210.48M
216	30	2/7/42	48	1,8	1,2	-5° Neg.	10° ATB + 8° Shear	10	272.216.48M
235	30 (+25)	2/7/42	48	2,4	1,6	18°	10° ATB + 8° Shear	10	272.235.48M
250	30	COMB3	60	2,4	1,6	15°	10° ATB + 8° Shear	10	272.250.60M
300	30	COMB3	72	2,6	1,8	15°	10° ATB + 8° Shear	5	272.300.72M
305	30	COMB3	72	2,6	1,8	-5° Neg.	10° ATB	5	272.305.72M



285 ORANGE CHROME®



PERFORMANCE

WOOD

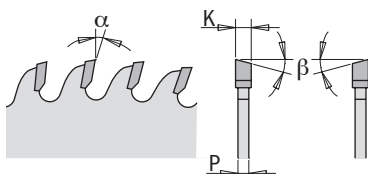

Machines

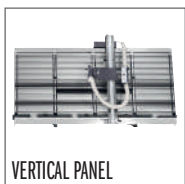

Blade diameter compatibility is contingent on machine type.

Applications

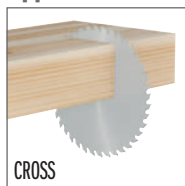

Materials



For specific details regarding suggested materials, please check blade label.

D mm	B mm	PIN HOLE ⊕⊗⊕	Z	K mm	P mm	α	β		ORDER NO.
160	20	2/6/32	48	2,2	1,6	5°	12° ATB	5	285.760.48H ●
190	20 (FESTOOL® FF)	-	48	2,4	1,8	8°	15° ATB	5	285.790.48FF ●
216	30	2/7/42	60	2,3	1,6	-5° Neg.	15° ATB	5	285.816.60M ●
250	30	COMBI3	80	3,2	2,2	5°	15° ATB	5	285.680.10M
300	30	COMBI3	96	3,2	2,2	5°	15° ATB	3	285.696.12M
350	30	COMBI3	108	3,5	2,5	5°	15° ATB	2	285.708.14M

● Ideal for FESTOOL®

285 INDUSTRIAL



WOOD

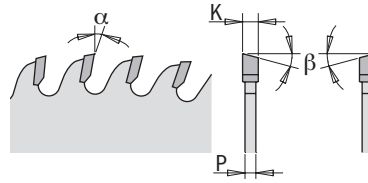

Machines



Blade diameter compatibility is contingent on machine type.

Applications



Materials

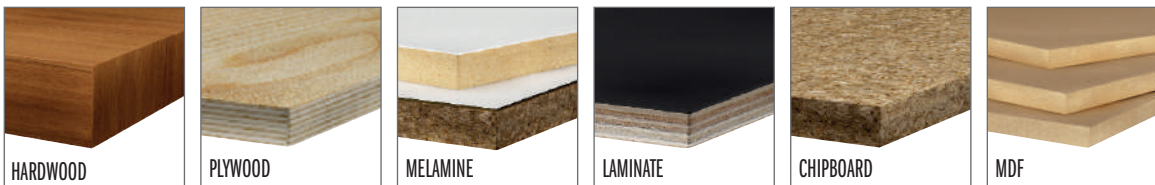

D mm	B mm	PIN HOLE 	Z	K mm	P mm	α	β		ORDER NO.
250	30	COMBI3	80	3,2	2,2	5°	15° ATB	1	285.080.10M
250	35	-	80	3,2	2,2	5°	15° ATB	1	285.080.10R
300	30	COMBI3	96	3,2	2,2	5°	15° ATB	1	285.096.12M
300	35	-	96	3,2	2,2	5°	15° ATB	1	285.096.12R
350	30	COMBI3	108	3,5	2,5	5°	15° ATB	1	285.108.14M
350	35	-	108	3,5	2,5	5°	15° ATB	1	285.108.14R
400	30	COMBI3	96	3,5	2,5	10°	15° ATB	1	285.096.16M
400	30	COMBI3	120	3,5	2,5	10°	15° ATB	1	285.120.16M



285-292-294 INDUSTRIAL



WOOD

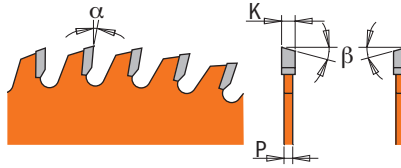

Machines



Blade diameter compatibility is contingent on machine type.

Applications



Materials



D mm	B mm	PIN HOLE	Z	K mm	P mm	α	β		ORDER NO.
160	20	2/6/32	56	2,2	1,6	15°	15° ATB	10	292.160.56H ●
165	20	2/6/32	56	2,2	1,6	15°	15° ATB	10	292.165.56H
190	30	2/7/42	64	2,6	1,6	15°	15° ATB	10	292.190.64M
200	30	COMBI3	64	3,2	2,2	5°	15° ATB	10	285.064.08M
210	30	2/7/42	64	2,8	1,8	15°	15° ATB	10	292.210.64M ●
216	30	2/7/42	80	2,8	1,8	-5° Neg.	15° ATB	10	292.216.80M ●
230	30	2/7/42 + 2/10/60	64	2,8	1,8	15°	15° ATB	10	292.230.64M ●
260	30	COMBI3	80	2,5	1,8	-5° Neg.	15° ATB	5	294.080.11M ●

● Ideal for FESTOOL®



273 ITK PLUS®



WOOD

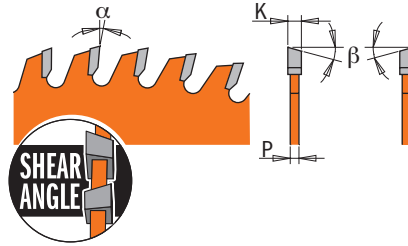

Machines



Blade diameter compatibility is contingent on machine type.

Applications



Materials



For specific details regarding suggested materials, please check blade label.

D mm	B mm	PIN HOLE ⊕⊗⊕	Z	K mm	P mm	α	β		ORDER NO.
new 50	10	-	20	1,1	0,8	15°	10° ATB	10	273.050.20D ●
new 80	10	-	36	1,6	1,0	15°	10° ATB	10	273.080.36D ●
160	20 (+16)	2/6/32	56	1,8	1,2	12°	10° ATB + 8° Shear	10	273.160.56H
new 165	20 (+15,87)	2/6/32	56	1,6	1,0	12°	15° ATB + 8° Shear	10	273.165.56H
190	30 (+20+16)	2/7/42	64	1,7	1,1	15°	10° ATB + 8° Shear	10	273.190.64M
216	30	2/7/42	64	1,8	1,2	-5° Neg.	10° ATB + 8° Shear	10	273.216.64M
250	30	COMBI3	80	2,4	1,6	12°	10° ATB + 8° Shear	10	273.250.80M
300	30	COMBI3	96	2,6	1,8	12°	10° ATB + 8° Shear	5	273.300.96M

● Ideal for PROXXON® (Materials: Wood, Plastic, Non-ferrous)

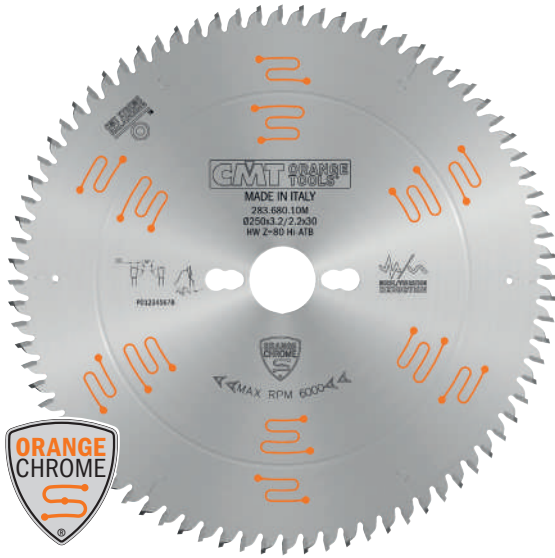

283.6 ORANGE CHROME®



WOOD

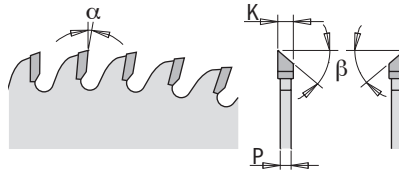

Machines

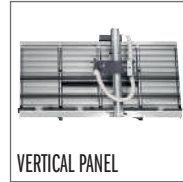

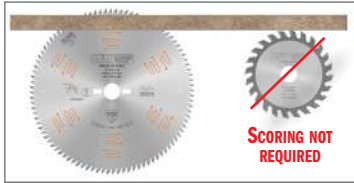

Blade diameter compatibility is contingent on machine type.

Applications

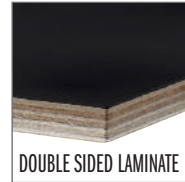

Materials



D mm	B mm	PIN HOLE 	Z	K mm	P mm	α	β		ORDER NO.
250	30	COMBI3	80	3,2	2,2	-2° Neg.	38° Hi-ATB	5	283.680.10M
300	30	COMBI3	96	3,2	2,2	2°	38° Hi-ATB	5	283.696.12M



283 INDUSTRIAL

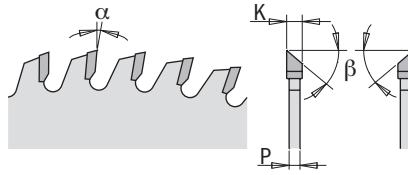

WOOD

Machines



Blade diameter compatibility is contingent on machine type.

Applications



Materials

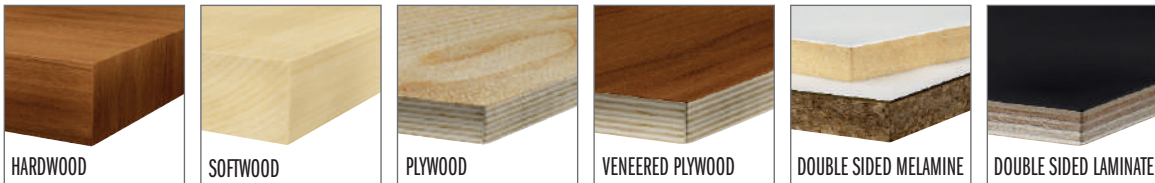

D mm	B mm	PIN HOLE 	Z	K mm	P mm	α	β		ORDER NO.
220*	30	2/7/42	64	3,2	2,2	-5° Neg.	40° Hi-ATB	1	283.064.09M
250	30	COMBI3	80	3,2	2,2	-2° Neg.	40° Hi-ATB	1	283.080.10M
300	30	COMBI3	96	3,2	2,2	2°	40° Hi-ATB	1	283.096.12M
350	30	COMBI3	108	3,5	2,5	5°	40° Hi-ATB	1	283.108.14M

*Non-Silent Blades



274 INDUSTRIAL



WOOD

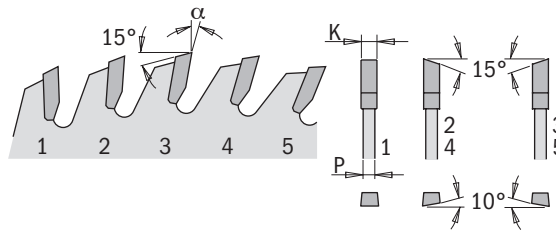

Machines



Blade diameter compatibility is contingent on machine type.

Applications



Materials

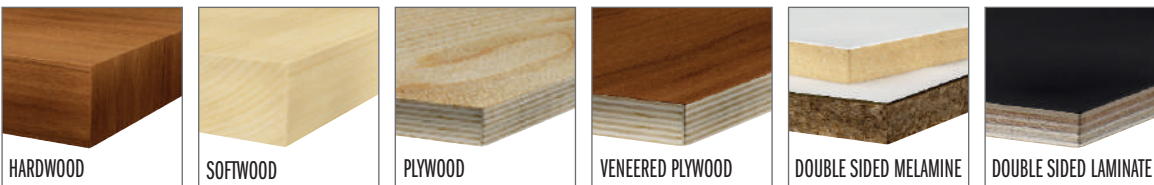

D mm	B mm	PIN HOLE 	Z	K mm	P mm	α	β		ORDER NO.
250	30	COMBI3	80	3,2	2,2	15°	1° FLAT + 4° ATB	1	274.080.10M
300	30	COMBI3	100	3,2	2,2	15°	1° FLAT + 4° ATB	1	274.100.12M

285.5 ORANGE CHROME®

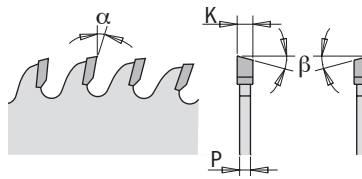

Machines



Blade diameter compatibility is contingent on machine type.

Applications



Materials

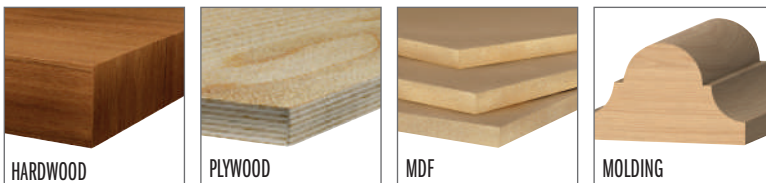

D mm	B mm	PIN HOLE 	Z	K mm	P mm	α	β		ORDER NO.
250	30	COMBI3	80	3,0	2,5	10°	20° ATB	5	285.580.10M
300	30	COMBI3	96	3,0	2,5	10°	20° ATB	5	285.596.12M



287 INDUSTRIAL

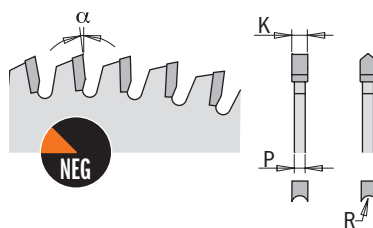

WOOD

Machines



Blade diameter compatibility is contingent on machine type.

Applications



Materials

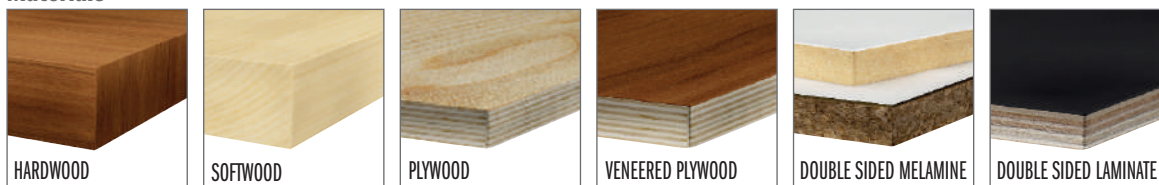

D mm	B mm	PIN HOLE 	Z	K mm	P mm	α	β		ORDER NO.
220	30	2/7/42	42	3,2	2,2	-6° Neg.	HDF	1	287.043.09M
250	30	COMBI3	48	3,2	2,2	-6° Neg.	HDF	1	287.049.10M
303	30	COMBI3	60	3,2	2,2	-6° Neg.	HDF	1	287.061.12M

287 INDUSTRIAL

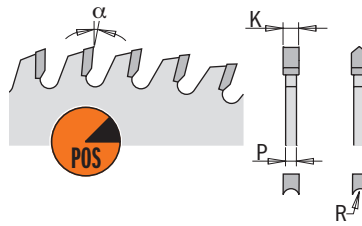

HW

★ ★ ★ ★ ★
PERFORMANCE

WOOD

Machines

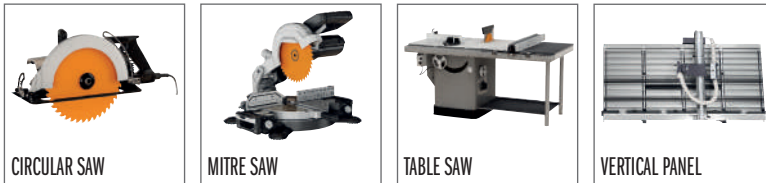

Blade diameter compatibility is contingent on machine type.

Applications



Materials

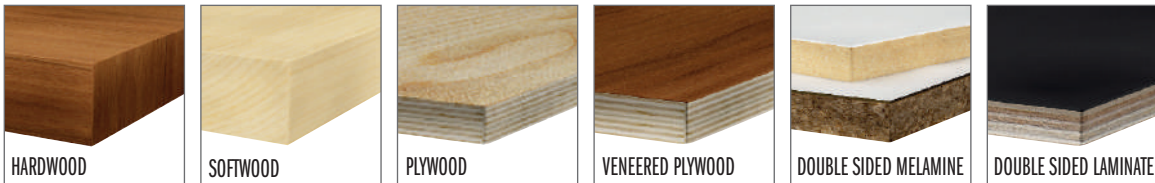

D mm	B mm	PIN HOLE 	Z	K mm	P mm	α	β		ORDER NO.
160	20	2/6/32	34	2,6	1,8	10°	HDF	5	287.034.06H
220	30	2/7/42	42	3,2	2,2	10°	HDF	1	287.042.09M
250	30	COMBI3	48	3,2	2,2	10°	HDF	1	287.048.10M
303	30	COMBI3	60	3,2	2,2	10°	HDF	1	287.060.12M

281



WOOD

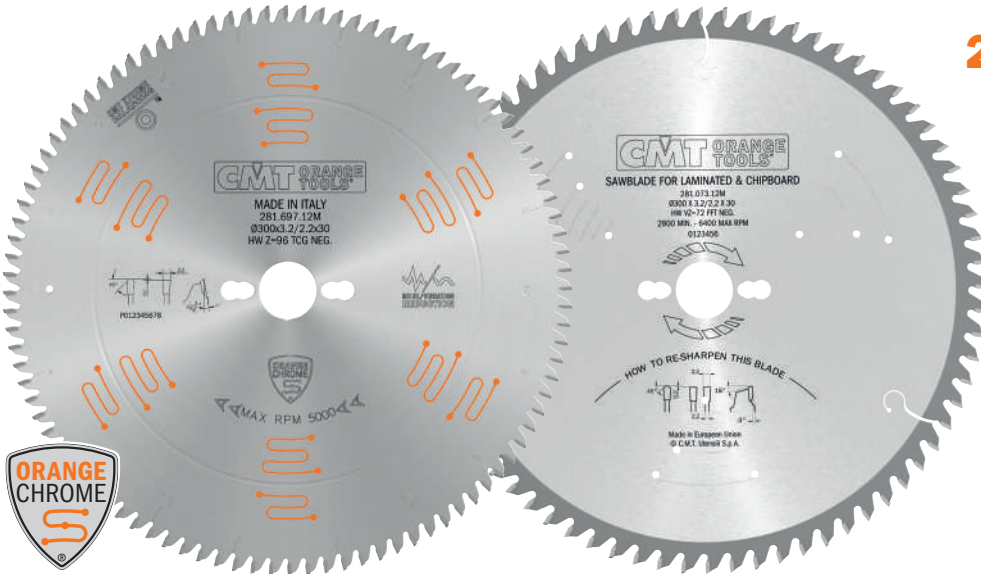

Images are not in scale with each other.



Machines

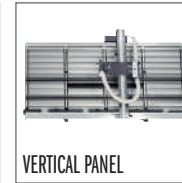

Applications



Blade diameter compatibility is contingent on machine type.

Materials

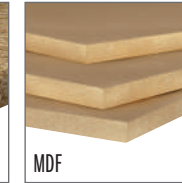
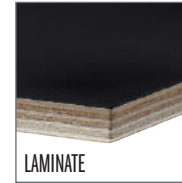

281 ORANGE CHROME®

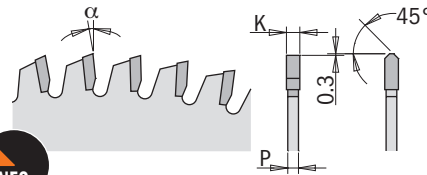

D mm	B mm	PIN HOLE	Z	K mm	P mm	α	β	Box	ORDER NO.
250	30	COMBI3	80	3,2	2,2	-3° Neg.	TCG	5	281.681.10M
300	30	COMBI3	96	3,2	2,2	-3° Neg.	TCG	5	281.697.12M

281 INDUSTRIAL

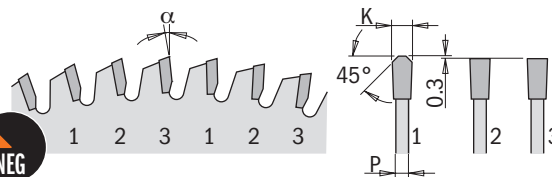

D mm	B mm	PIN HOLE	Z	K mm	P mm	α	β	Box	ORDER NO.
220	30	COMBI3	63	3,2	2,2	-3° Neg.	FFT	1	281.063.09M
250	30	COMBI3	60	3,2	2,2	-3° Neg.	FFT	1	281.061.10M
300	30	COMBI3	72	3,2	2,2	-3° Neg.	FFT	1	281.073.12M

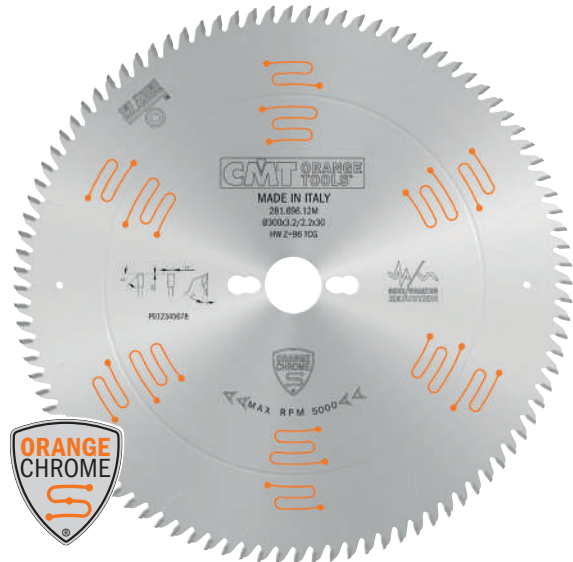

281 ORANGE CHROME®



PERFORMANCE

WOOD

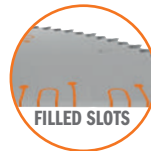
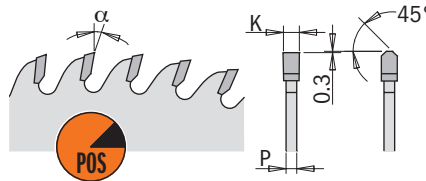

Machines

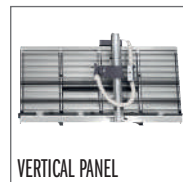

Blade diameter compatibility is contingent on machine type.

Applications



Materials

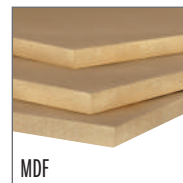

D mm	B mm	PIN HOLE	Z	K mm	P mm	α	β		ORDER NO.
new 160	20	2/6/32	48	2,2	1,6	4°	TCG	5	281.760.48H ●
new 190	20 (FESTOOL® FF)	-	54	2,6	1,8	4°	TCG	5	281.790.54FF ●
250	30	COMBI3	80	3,2	2,2	5°	TCG	5	281.680.10M
300	30	COMBI3	72	3,2	2,2	10°	TCG	5	281.672.12M
300	30	COMBI3	96	3,2	2,2	5°	TCG	5	281.696.12M
350	30	COMBI3	84	3,5	2,5	10°	TCG	3	281.684.14M
350	30	COMBI3	108	3,5	2,5	5°	TCG	3	281.708.14M

● Ideal for FESTOOL®



295 XTREME

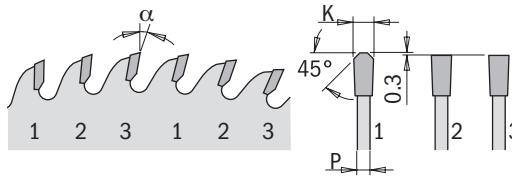

WOOD



Machines





Blade diameter compatibility is contingent on machine type.

Applications

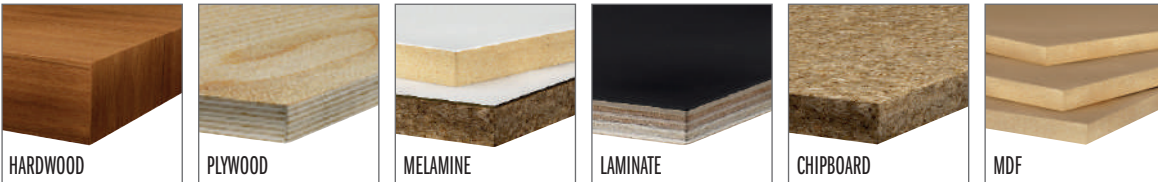

Materials



D mm	B mm	PIN HOLE 	Z	K mm	P mm	α	β		ORDER NO.
250	30	COMBI3	78	3,2	2,2	10°	FFT	5	295.078.10M
300	30	COMBI3	96	3,2	2,2	10°	FFT	5	295.096.12M
350	30	COMBI3	108	3,5	2,5	10°	FFT	3	295.108.14M

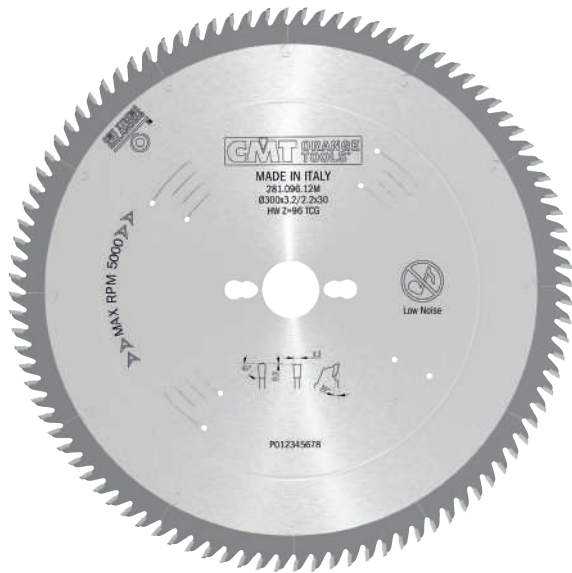

281 XTREME

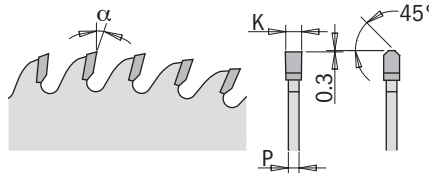

PERFORMANCE

WOOD

Machines



MITRE SAW



RADIAL ARM



TABLE SAW



VERTICAL PANEL

Blade diameter compatibility is contingent on machine type.

Applications



CROSS

Materials



HARDWOOD



PLYWOOD

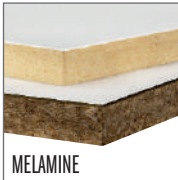

MELAMINE





LAMINATE

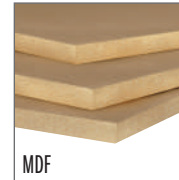

CHIPBOARD



MDF

D mm	B mm	PIN HOLE 	Z	K mm	P mm	α	β		ORDER NO.
190*	20 (FESTOOL® FF)	-	54	2,6	1,8	4°	TCG	5	281.190.54FF ■
250	30	COMBI3	60	3,2	2,2	10°	TCG	5	281.060.10M
250	30	COMBI3	80	3,2	2,2	10°	TCG	5	281.080.10M
300	30	COMBI3	72	3,2	2,2	10°	TCG	5	281.072.12M
300	30	COMBI3	96	3,2	2,2	10°	TCG	5	281.096.12M
350	30	COMBI3	84	3,5	2,5	10°	TCG	3	281.084.14M
350	30	COMBI3	108	3,5	2,5	10°	TCG	3	281.108.14M

*Non-Silent Blades

■ Until stock last



281 INDUSTRIAL



WOOD

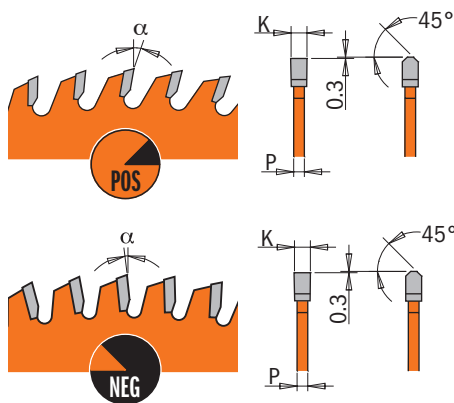

Machines



Blade diameter compatibility is contingent on machine type.

Applications

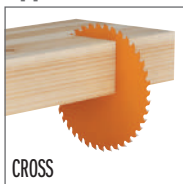

Materials



For specific details regarding suggested materials, please check blade label.

Positive

D mm	B mm	PIN HOLE	Z	K mm	P mm	α	β	APPLICATIONS		ORDER NO.
160	20 (VIRUTEX®)	4/7/32 45°	40	2,2	1,6	10°	TCG	Finish	10	281.160.40H
160	20	2/6/32	48	2,2	1,6	5°	TCG	Fine Finish	10	281.160.48H ●
200	30	2/7/42	64	3,2	2,2	10°	TCG	Fine Finish	10	281.064.08M
220	30	2/7/42	64	3,2	2,2	10°	TCG	Fine Finish	10	281.064.09M
225	30	2/7/42	64	2,6	1,8	4°	TCG	Fine Finish	10	281.225.64M ●

● Ideal for FESTOOL®

Negative

D mm	B mm	PIN HOLE	Z	K mm	P mm	α	β	APPLICATIONS		ORDER NO.
160	20	2/6/32	56	2,2	1,6	-3° Neg.	TCG	Ultra Finish	10	281.161.56H ●
165	20	2/6/32	56	2,2	1,6	-3° Neg.	TCG	Ultra Finish	10	281.166.56H
260	30	COMBI3	64	2,5	1,8	-3° Neg.	TCG	Finish	5	281.065.11M ●

● Ideal for FESTOOL®

281-282 INDUSTRIAL
X-TREME

HW
PERFORMANCE
WOOD

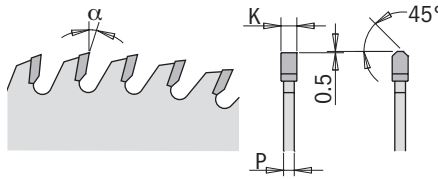

Machines

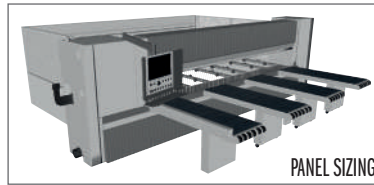

D mm	B mm	PIN HOLE	Z	K mm	P mm	α	β	LOW NOISE		ORDER NO. INDUSTRIAL	ORDER NO. X-TREME
250	30	COMBI3	60	3,2	2,2	10°	TCG		1		281.060.10M
250	30	COMBI3	80	3,2	2,2	10°	TCG		1		281.080.10M
300	30	COMBI3	60	4,4	3,2	16°	TCG		1		282.060.12M
300	30	COMBI3	72	3,2	2,2	10°	TCG		5		281.072.12M
300	30	COMBI3	96	3,2	2,2	10°	TCG		1		281.096.12M
300	75	-	60	4,4	3,2	16°	TCG		1		282.060.12X
300	80	COMBI5	60	4,4	3,2	16°	TCG		1		282.060.12W
320	65	2/9/100 + 2/9/110	60	4,4	3,2	16°	TCG		1		Y282.060.13J
320	65	2/9/100 + 2/9/110	72	4,4	3,2	16°	TCG		1		282.072.13J
350	30	COMBI3	54	4,4	3,2	16°	TCG		1	282.054.14M	
350	30	COMBI3	72	4,4	3,2	16°	TCG		1		282.072.14M
350	30	COMBI3	108	3,5	2,5	10°	TCG		1		281.108.14M
350	50	3/12,5/80	72	4,4	3,2	16°	TCG		1	282.072.14T	
350	60	2/14/100	72	4,4	3,2	16°	TCG		1		Y282.072.14U
350	75	4/15/105 + 3/7/100	54	4,4	3,2	16°	TCG		1	282.054.14X	
350	75	4/15/105 + 3/7/100	72	4,4	3,2	16°	TCG		1		282.072.14X
350	80	COMBI5	54	4,4	3,2	16°	TCG		1	282.054.14W	
350	80	COMBI5	72	4,4	3,2	16°	TCG		1		282.072.14W
355	30	COMBI3	72	4,4	3,2	16°	TCG		1	S282.03556	
355	65	2/9/100 + 2/9/110	72	4,4	3,2	16°	TCG		1		282.072.14J2
355	80	4/9/100 + 2/9/110 + 2/14/110	72	4,4	3,2	10°	TCG		1		282.072.14W2
380	60	2/14/100	72	4,4	3,2	15°	TCG		1		282.072.15U2
380	60	COMBI7	72	4,8	3,5	16°	TCG		1		282.072.15U
380	80	COMBI5	72	4,4	3,2	16°	TCG		1		282.072.15W
400	30	2/10/60	60	4,4	3,2	16°	TCG		1		282.060.16M
400	30	2/10/60	72	4,4	3,2	16°	TCG		1		282.072.16M
400	60	COMBI7	72	4,4	3,2	16°	TCG		1		282.072.16U
400	75	4/15/105	60	4,4	3,2	16°	TCG		1	282.060.16X	
400	75	4/15/105	72	4,4	3,2	16°	TCG		1		282.072.16X
400	80	COMBI5	60	4,4	3,2	16°	TCG		1	282.060.16W	
400	80	COMBI5	72	4,4	3,2	16°	TCG		1		282.072.16W
420	80	4/9/100 + 2/9/110 + 2/14/110	72	4,4	3,2	15°	TCG		1		282.072.17W
430	65	2/9/100 + 2/9/110	72	4,4	3,2	16°	TCG		1		Y282.072.17J
430	75	4 / 15/105	72	4,4	3,2	16°	TCG		1		282.072.17X
430	80	COMBI5	72	4,4	3,2	16°	TCG		1		282.072.17W2
450	30	COMBI3 + 2/14/95	72	4,4	3,2	16°	TCG		1		Y282.072.18M2
450	60	COMBI7	72	4,8	3,5	16°	TCG		1		282.072.18U
450	80	COMBI5	72	4,8	3,5	16°	TCG		1		282.072.18W2
500	60	COMBI7	72	4,8	3,5	16°	TCG		1		282.072.20U
500	80	COMBI5	72	4,8	3,5	16°	TCG		1	Y282.072.20W ■	
550	100	-	72	5,2	3,5	16°	TCG		1	282.072.22A ■	

■ Until stock last



WOOD



289 XTREME

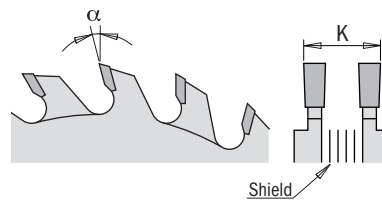

Tips: suggested for machines without vertical regulation of scoring blade.

Machines



Applications

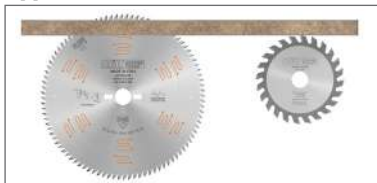

Materials



D mm	B mm	Z	K mm	α	β		ORDER NO.
70	20	8+8	2,8-3,6	12°	FLAT	10	289.070.16H
80	20	10+10	2,8-3,6	12°	FLAT	10	289.080.20H
100	20	10+10	2,8-3,6	12°	FLAT	10	289.100.20H
100	22	10+10	2,8-3,6	12°	FLAT	10	289.100.20K
120	20	12+12	2,8-3,6	12°	FLAT	10	289.120.24H
120	22	12+12	2,8-3,6	12°	FLAT	10	289.120.24K
120	50	12+12	2,8-3,6	12°	FLAT	10	289.120.24T ●
125	20	12+12	2,8-3,6	12°	FLAT	10	289.125.24H
125	22	12+12	2,8-3,6	12°	FLAT	10	289.125.24K



299.000.05H
299.000.05H
299.000.02K
299.000.02K
299.000.02K
299.000.02K
299.000.02K
299.000.02K
299.000.02K

● Ideal for ALTENDORF® Rapido System



288 XTREME

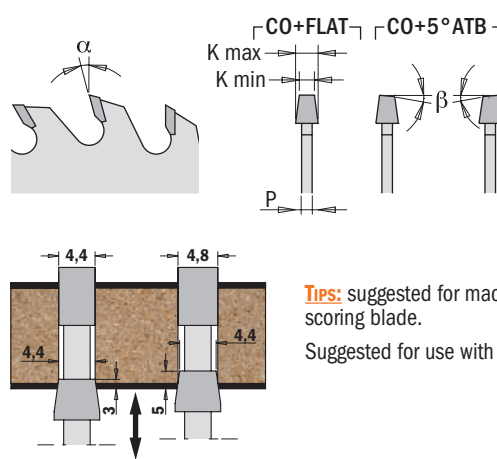

PERFORMANCE

WOOD

Tips: suggested for machines with vertical regulation of scoring blade.
Suggested for use with thick kerf or panel sizing blade.

Machines



Applications

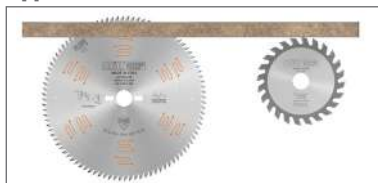

Materials

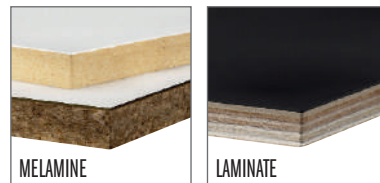

D mm	B mm	PIN HOLE	Z	K mm	P mm	α	β		ORDER NO.
80	20	-	12	3,1-3,6	2,2	10°	CO+FLAT	10	S288.080.12H
100	20	-	20	3,1-4,0	2,2	5°	CO+5° ATB	10	288.100.20H
100	22	-	20	3,1-4,0	2,2	5°	CO+5° ATB	10	288.100.20K
120	20	-	24	3,1-4,0	2,2	5°	CO+5° ATB	10	288.120.24H
120	20	-	24	3,4-4,2	2,5	5°	CO+5° ATB	10	288.120.24H1
120	22	-	24	3,1-4,0	2,2	5°	CO+5° ATB	10	288.120.24K
125	20	-	24	3,1-4,0	2,2	5°	CO+5° ATB	10	288.125.24H
125	20	-	24	3,4-4,2	2,5	5°	CO+5° ATB	10	288.125.24H1
125	20	-	24	4,3-5,5	3,2	10°	CO+FLAT	10	288.125.24H2
125	22	-	24	3,1-4,0	2,2	5°	CO+5° ATB	10	288.125.24K
125	45	-	24	4,3-5,5	3,2	10°	CO+FLAT	10	288.125.24Q
140	16	1/6/33	24	3,1-4,0	2,2	10°	CO+FLAT	5	Y288.140.24E ■
150	45	3/11/70	36	4,3-5,5	3,2	10°	CO+FLAT	5	288.150.36Q
160	45	3/11/70	36	4,3-5,5	3,2	10°	CO+FLAT	5	288.160.36Q
160	55	3/7/66 + 3/6/84	36	4,3-5,5	3,2	10°	CO+FLAT	5	288.160.36Q
180	20	-	36	4,3-5,5	3,2	10°	CO+FLAT	5	Y288.180.36H ■
180	30	COMBI3	36	4,5-5,5	3,2	10°	CO+FLAT	5	288.180.36M
180	45	-	36	4,3-5,5	3,2	8°	CO+5° ATB	5	288.180.36Q2
180	45	-	36	4,7-6,0	3,5	10°	CO+FLAT	5	288.180.36Q
180	55	-	36	5,0-6,2	3,5	10°	CO+FLAT	5	288.180.36Q ■
180	50	3/12,5/80	44	4,3-5,5	3,2	10°	CO+FLAT	5	288.180.44T
200	20	-	36	4,4-5,3	3,2	10°	CO+FLAT	5	288.200.36H
200	45	-	36	4,7-6,0	3,5	10°	CO+FLAT	5	288.200.36Q
200	45	-	36	4,3-5,5	3,2	10°	CO+FLAT	5	Y288.200.36Q2
200	65	2/9/100 + 2/9/110	36	4,4-5,3	3,2	10°	CO+FLAT	5	288.200.36J
215	50	3/15/80	42	4,3-5,5	3,2	8°	CO+FLAT	5	288.215.42T
300	50	3/15/80	48	4,3-5,5	3,2	10°	CO+FLAT	5	288.300.48T
300	65	2/9/100 + 2/9/110	72	4,3-5,5	3,2	10°	CO+FLAT	5	288.300.72J

■ Until stock last

DP - Laminated & Chipboard



237 XTREME



WOOD

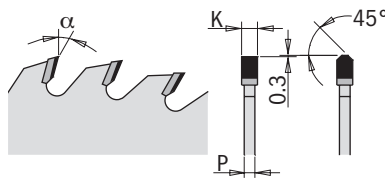

50X
LONGER LIFE
THAN CARBIDE

Machines

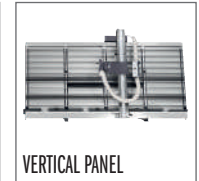

Blade diameter compatibility is contingent on machine type.

High-quality nickel-plated saw blades with anti-friction and anti-corrosion properties.

Applications



Materials

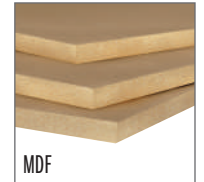

D mm	B mm	PIN HOLE	Z	K mm	P mm	α	β		ORDER NO.
250	30	COMBI3	48	3,2	2,2	10°	TCG	1	237.048.10M
300	30	COMBI3	60	3,2	2,2	10°	TCG	1	237.060.12M
300	30	COMBI3	96	3,2	2,2	15°	TCG	1	237.096.12M
350	30	COMBI3	72	3,5	2,4	15°	TCG	1	237.072.14M

DP - Conical Scoring



238 XTREME



WOOD

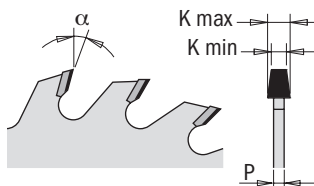

50X
LONGER LIFE
THAN CARBIDE

Machines



Applications

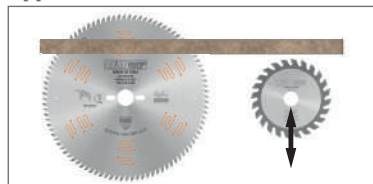

Materials



D mm	B mm	Z	K mm	P mm	α	β		ORDER NO.
120	20	20	3,1-3,7	2,2	5°	CONICAL	1	238.120.20H
125	20	20	3,1-3,7	2,2	5°	CONICAL	1	238.125.20H

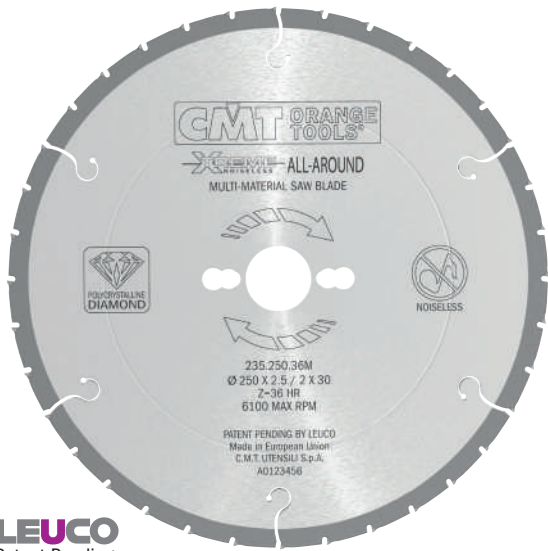

LEUCO
Patent Pending

235 XTREME ALL-AROUND



MULTI-MATERIALS

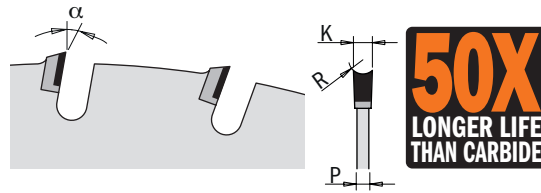

50X
LONGER LIFE
THAN CARBIDE

Machines



Blade diameter compatibility is contingent on machine type.

Materials

NO LIMITS: CUT ALL WITH ONE BLADE!

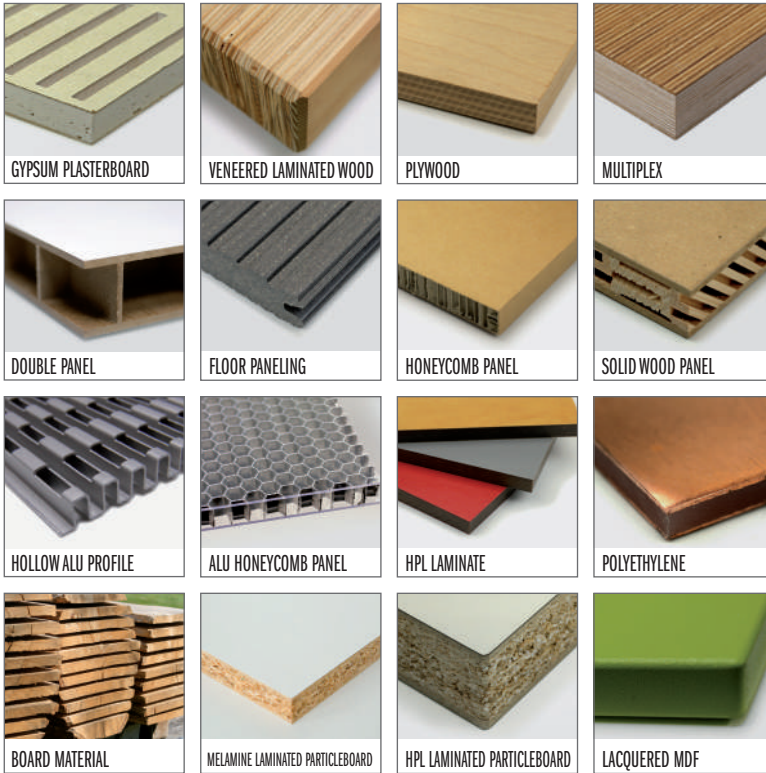

XTREME-NOISELESS

Thanks the new minimization of gullets design this blade succeeded in reducing the noise of idling by up to 15 dB(A) compared to conventional carbide saw blades. With a noise level of just around 70dB(A) when idling, the wearing of hearing protection is outdated.

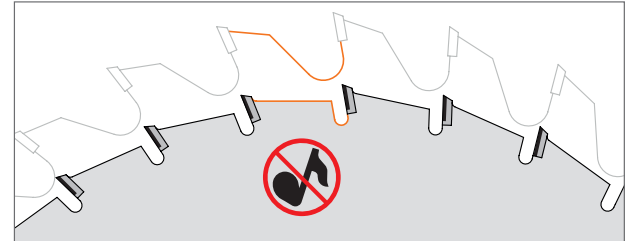

XTREME-ALL-AROUND

New industry standard with universal application in countless materials and suitable for all chop saws and portable machines, table and vertical panel sizing saws, CNCs and through-feed installations

XTREME-QUALITY

The special hollow back tooth configuration (HR) guarantees an excellent cutting quality.

XTREME-FAST

The teeth are surprisingly thin! The cutting width is a mere 2,5 mm and they generate noticeably lower cutting pressure and therefore also require less power during usage. Resharpenable max 2 times.

XTREME-LIFETIME

The lifetime is 20X longer than carbide blades thanks to the diamond tips.

RECOMMENDED USE

We recommend the use of a splitting wedge between **2,0** and **2,4**mm in thickness.

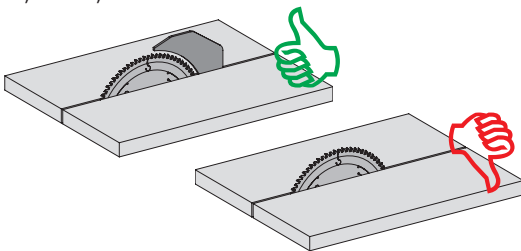

LONGER LIFETIME THANKS TO DIAMOND TIPS Clean your circular saw blades on a regular basis. You will profit from a long-lasting and precise cutting quality and maximize the lifetime of your innovative saw blades many times over.

- It is not recommended to use the saw blades for longitudinal cuts in soft wood and material thicknesses of more than 40mm.
- Do not cut materials with nails, stone and metal parts.
- Chip-free cuts can only be guaranteed in combination with a suitable scoring saw blade.

D mm	B mm	PIN HOLE ⊕⊗	Z	K mm	P mm	α	β		ORDER NO.
160	20	2/6/32	20	2,2	1,6	10°	HR	1	235.160.20H
190	30	2/7/42	24	2,5	2,0	10°	HR	1	235.190.24M
216	30	2/7/42	30	2,5	2,0	10°	HR	1	235.216.30M
250	30	COMBI3	36	2,5	2,0	10°	HR	1	235.250.36M
300	30	COMBI3	44	2,5	2,0	10°	HR	1	235.300.44M

284



NON-FERROUS

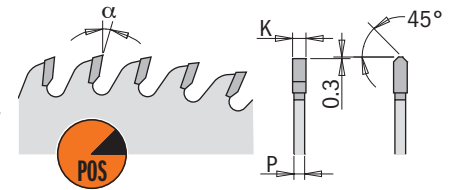
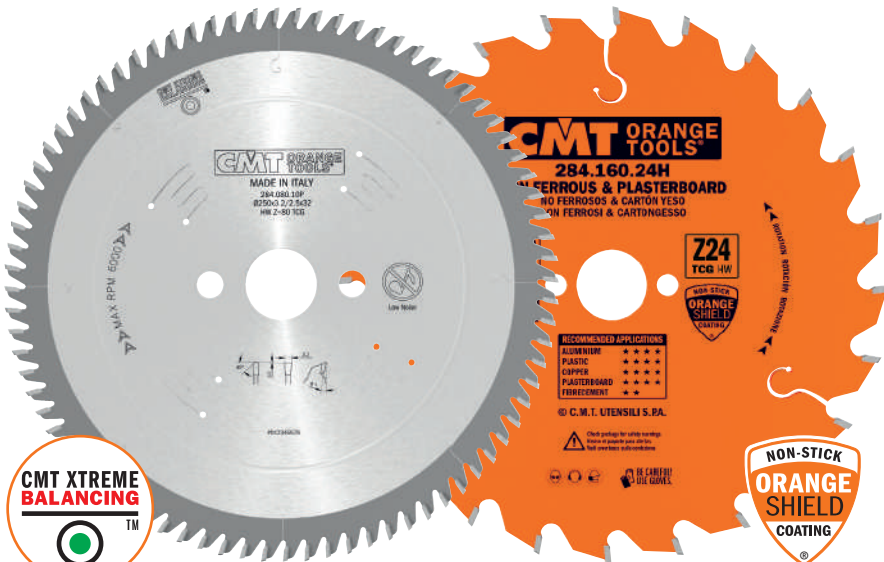

Images are not in scale with each other.

Machines

*WITH MEC/MAN WORKPIECE CLAMPING

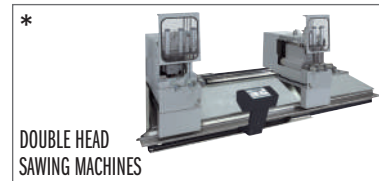

Blade diameter compatibility is contingent on machine type.

Materials

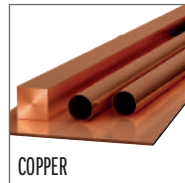
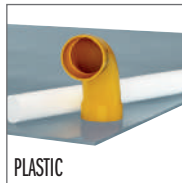

For specific details regarding suggested materials, please check blade label.

284 XTREME



D mm	B mm	PIN HOLE	Z	K mm	P mm	α	β	Box	ORDER NO.
250	32	2/12/64	80	3,2	2,5	6°	TCG	5	284.080.10P
300	32	2/12/64	96	3,2	2,5	6°	TCG	5	284.096.12P
350	32	2/12/64	84	3,6	3,0	6°	TCG	3	284.092.14P
350	32	2/12/64	108	3,6	3,0	6°	TCG	3	284.108.14P
400	32	2/12/64	96	4,0	3,2	6°	TCG	2	284.096.16P
420	32	2/12/64	96	3,8	3,2	6°	TCG	2	284.096.17P
450	30	2/10/60	108	4,2	3,5	6°	TCG	2	284.108.18M
450	32	2/12/64	108	4,2	3,5	6°	TCG	2	284.108.18P
500	30	2/10/60	120	4,3	3,5	10°	TCG	2	284.120.20M
500	32	2/12/64	120	4,3	3,5	10°	TCG	2	284.120.20P

284 INDUSTRIAL

NON-STICK ORANGE SHIELD COATING®



D mm	B mm	PIN HOLE	Z	K mm	P mm	α	β	Box	ORDER NO.
160	20	2/6/32	24	2,2	1,6	5°	TCG	10	284.160.24H ●
190	30	2/7/42	30	2,6	2,2	5°	TCG	10	284.190.30M
216	30	2/7/42	40	2,6	2,2	5°	TCG	10	284.216.40M ●

● Ideal for FESTOOL®

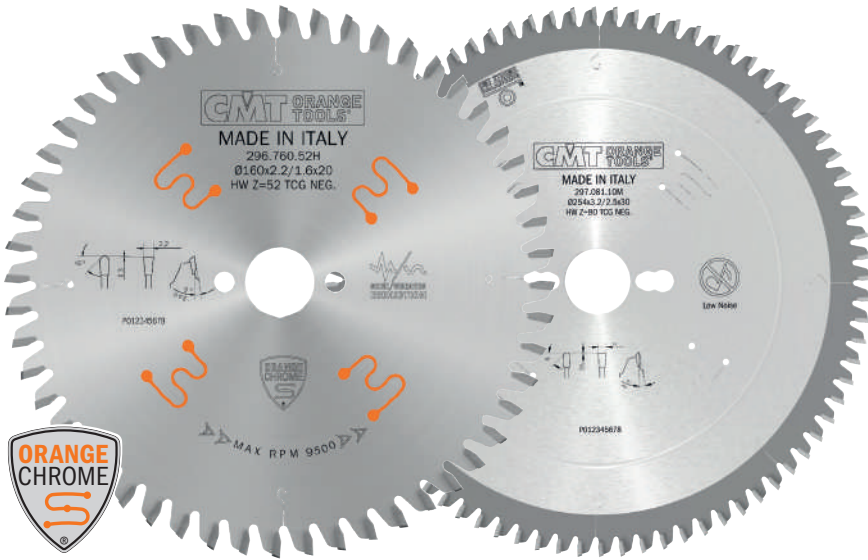

296-297



NON-FERROUS

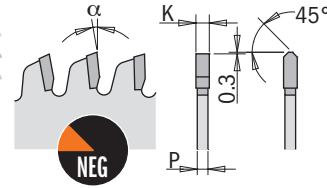

Images are not in scale with each other.

Machines



Blade diameter compatibility is contingent on machine type.

Materials

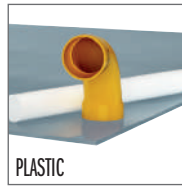
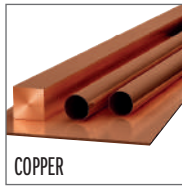

296-297 ORANGE CHROME®

● IDEAL FOR FESTOOL®

D mm	B mm	PIN HOLE	Z	K mm	P mm	α	β	Box	ORDER NO.
160	20	2/6/32	52	2,2	1,8	-5° Neg.	TCG	5	296.760.52H ●
216	30	2/7/42	64	2,3	1,6	0°	TCG	5	297.816.64M ●

297 XTREME

250	30	COMBI3	80	3,2	2,5	-6° Neg.	TCG	5	297.080.10M
250	32	2/12/64	80	3,2	2,5	-6° Neg.	TCG	5	297.080.10P
254	30	COMBI3	80	3,2	2,5	-6° Neg.	TCG	5	297.081.10M
260	30	COMBI3	80	3,2	2,5	-6° Neg.	TCG	5	297.080.11M
280	30	COMBI3	64	3,2	2,5	-6° Neg.	TCG	5	297.064.11M
300	30	COMBI3	96	3,2	2,5	-6° Neg.	TCG	5	297.096.12M
300	32	2/12/64	96	3,2	2,5	-6° Neg.	TCG	5	297.096.12P
305	30	COMBI3	96	3,2	2,5	-6° Neg.	TCG	5	297.096.13M
315	30	COMBI3	96	3,2	2,5	-6° Neg.	TCG	5	297.096.23M
330	30	COMBI3	96	3,6	3,0	-6° Neg.	TCG	3	297.096.33M
330	32	COMBI3	96	3,6	3,0	-6° Neg.	TCG	3	297.096.33P
350	30	COMBI3	108	3,6	3,0	-6° Neg.	TCG	3	297.108.14M
350	32	4/12/64	108	3,6	3,0	-6° Neg.	TCG	3	297.108.14P
400	30	2/10/60	120	4,0	3,2	-6° Neg.	TCG	2	297.120.16M
400	32	4/12/64	96	4,0	3,2	-6° Neg.	TCG	2	297.108.16P
400	32	4/12/64	120	4,0	3,2	-6° Neg.	TCG	2	297.120.16P
450	30	2/10/60	96	4,2	3,5	-6° Neg.	TCG	2	297.108.18M
450	30	2/10/60	120	4,2	3,5	-6° Neg.	TCG	2	Y297.140.18M
450	32	2/12/64	96	4,2	3,5	-6° Neg.	TCG	2	297.108.18P
450	32	4/12/64	120	4,2	3,5	-6° Neg.	TCG	2	297.120.18P
500	30	2/10/60	120	4,3	3,5	-6° Neg.	TCG	2	297.120.20M
500	32	2/12/64	120	4,3	3,5	-6° Neg.	TCG	2	297.120.20P



296-297 INDUSTRIAL



NON-FERROUS

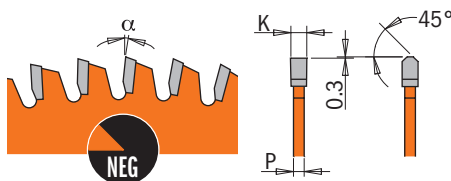

Machines

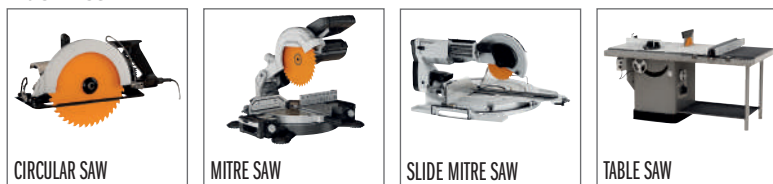

Blade diameter compatibility is contingent on machine type.

Materials

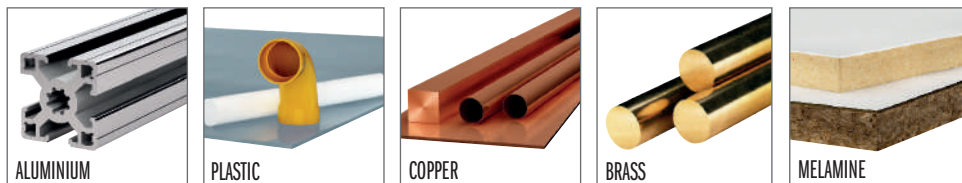

D mm	B mm	PIN HOLE 	Z	K mm	P mm	α	β		ORDER NO.
120	20	2/5,5/30	36	1,8	1,2	-6° Neg.	TCG	10	296.120.36H
160	20	2/6/32	40	2,2	1,6	-6° Neg.	TCG	10	296.160.40H ●
160	20	2/6/32	56	2,2	1,6	-6° Neg.	TCG	10	296.160.56H ●
165	20	2/6/32	40	2,2	1,6	-6° Neg.	TCG	10	296.165.40H
165	20	2/6/32	56	2,2	1,6	-6° Neg.	TCG	10	296.165.56H
180	20	2/6/32	40	2,8	2,2	-6° Neg.	TCG	10	296.180.40H
190	30	2/7/42	40	2,8	2,2	-6° Neg.	TCG	10	296.190.40M
190	30	2/7/42	64	2,8	2,2	-6° Neg.	TCG	10	296.190.64M
190	20 (FESTOOL® FF)	Key 5/7/2,5	64	2,8	2,2	-6° Neg.	TCG	10	296.190.64FF ●
200	30	COMBI3	48	2,8	2,2	-6° Neg.	TCG	10	296.200.48M
210	30	2/7/42	48	2,8	2,2	-6° Neg.	TCG	10	296.210.48M ●
210	30	2/7/42	64	2,8	2,2	-6° Neg.	TCG	10	296.210.64M ●
216	30	2/7/42	64	2,8	2,2	-6° Neg.	TCG	10	297.064.09M ●
216	30	2/7/42	80	2,8	2,2	-6° Neg.	TCG	10	297.080.09M ●
225	30	2/7/42	64	2,8	2,2	-6° Neg.	TCG	10	296.225.64M ●
230	30	2/7/42	48	2,8	2,2	-6° Neg.	TCG	10	296.230.48M ●
235	30	2/7/42	48	2,8	2,2	-6° Neg.	TCG	10	296.235.48M

● Ideal for FESTOOL®



276 ITK PLUS®



NON-FERROUS

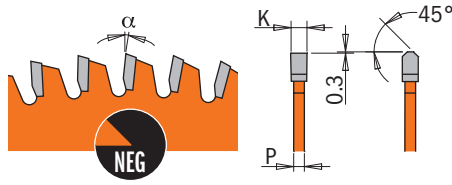

Machines



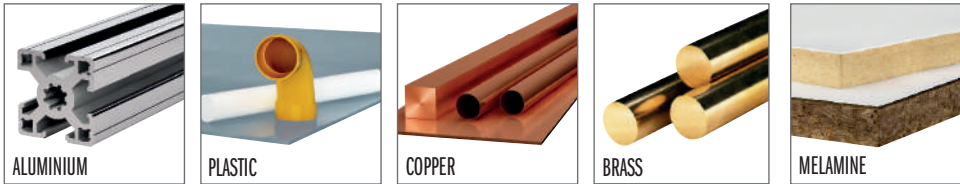

Blade diameter compatibility is contingent on machine type.

Materials



D mm	B mm	PIN HOLE	Z	K mm	P mm	α	β		ORDER NO.
new 140	20	2/6/32,5	48	1,8	1,2	-6° Neg.	TCG	10	276.140.48H
160	20 (+16)	2/6/32	48	1,8	1,2	-6° Neg.	TCG	10	276.160.48H
new 165	20 (+15,87)	2/6/32	56	1,8	1,2	-6° Neg.	TCG	10	276.165.56H
184	20 (+16+15,87)	2/7/42	48	1,8	1,2	-6° Neg.	TCG	10	276.184.48H
190	30 (+20+16)	2/7/42	64	1,8	1,2	-6° Neg.	TCG	10	276.190.64M
210	30 (+25)	2/7/42	64	1,8	1,2	-6° Neg.	TCG	10	276.210.64M
216	30	2/7/42	64	2,2	1,6	-6° Neg.	TCG	10	276.216.64M
250	30	COMBI3	80	2,6	1,8	-6° Neg.	TCG	10	276.250.80M
300	30	COMBI3	96	2,8	2,0	-6° Neg.	TCG	5	276.300.96M
305	30	COMBI3	96	2,8	2,0	-6° Neg.	TCG	5	276.305.96M

MATERIALS	COATING TYPE	
		
STEEL (<500 N/mm ²)	★ ★	★ ★ ★ ★
STEEL (<800 N/mm ²)	★ ★	★ ★ ★
STEEL (<1200 N/mm ²)	★ ★	★ ★ ★
STAINLESS STEEL	★ ★	★ ★ ★ ★
CAST IRON	★ ★	★ ★ ★ ★
ALUMINIUM/ALLOY AL.	★ ★	★ ★ ★ ★
TITANIUM	★	★ ★
BRONZE	NOT RECOMMENDED	★ ★ ★ ★
COPPER	NOT RECOMMENDED	★ ★ ★
BRASS	NOT RECOMMENDED	★ ★ ★
TECHNICAL INFO	VAPO	TiCN
COLOR	BLACK	BROWN - RED
HARDNESS (HV)	800	3200
THICKNESS (µm)	2 - 4	2 - 4
COEFFICIENT OF FRICTION	0.6	0.2
MAX. WORKING TEMPERATURE	350°C	450°C

SUGGESTED SPEED (BW - C/HZ)	
MATERIALS	V (m/min.) MIN. ~ MAX
STEEL (<500 N/mm ²):	30 ~ 60
STEEL (<800 N/mm ²):	25 ~ 40
STEEL (<1200 N/mm ²):	15 ~ 30
STAINLESS STEEL:	15 ~ 30
CAST IRON:	25 ~ 50
ALUMINIUM/ALLOY AL.:	500 ~ 700
TITANIUM:	15 ~ 20
BRONZE:	200 ~ 300
COPPER:	200 ~ 400
BRASS:	400 ~ 600

$$RPM = \frac{1000 \times V \text{ (m/min.)}}{3,14 \times D \text{ (mm)}}$$



227 HSS LINE



METAL & STEEL

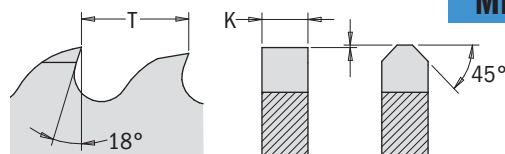

Sharpening

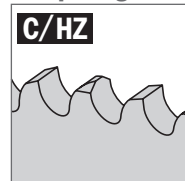

Applications



D mm	B mm	PIN HOLE	Z	K mm	PITCH T	β	COATING	ORDER NO.
250	32	2/8/45+2/9/50+2/11/63	128	2,0	T6	C/HZ	VAPO	227.250.128P
275	32	2/8/45+2/9/50+2/11/63	140	2,5	T6	C/HZ	VAPO	227.275.140P
300	32	2/8/45+2/9/50+2/11/63	160	2,5	T6	C/HZ	VAPO	227.300.160P
315	32	2/8/45+2/9/50+2/11/63	160	2,5	T6	C/HZ	VAPO	227.315.160P
350	32	2/8/45+2/9/50+2/11/63	180	2,5	T6	C/HZ	VAPO	227.350.180P



227 HSS LINE



METAL & STEEL

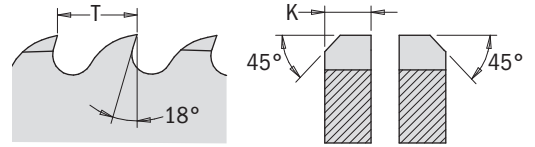

Sharpening

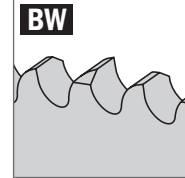

Applications



D mm	B mm	PIN HOLE	Z	K mm	PITCH T	β	COATING	ORDER NO.
200	32	2/8/45+2/9/50+2/11/63	160	1,8	T4	BW	VAPO	227.200.160P
225	32	2/8/45+2/9/50+2/11/63	180	1,9	T4	BW	VAPO	227.225.180P
250	32	2/8/45+2/9/50+2/11/63	160	2,0	T5	BW	VAPO	227.250.160P
250	32	2/8/45+2/9/50+2/11/63	200	2,0	T4	BW	VAPO	227.250.200P
275	32	2/8/45+2/9/50+2/11/63	220	2,5	T4	BW	VAPO	227.275.220P
300	32	2/8/45+2/9/50+2/11/63	220	2,5	T4	BW	VAPO	227.300.220P
315	32	2/8/45+2/9/50+2/11/63	240	2,5	T4	BW	VAPO	227.315.240P
350	32	2/8/45+2/9/50+2/11/63	280	2,5	T4	BW	VAPO	227.350.280P

D mm	B mm	PIN HOLE	Z	K mm	PITCH T	β	COATING	ORDER NO.
250	32	2/8/45+2/9/50+2/11/63	200	2,0	T4	BW	TiCN	227.250.700P
275	32	2/8/45+2/9/50+2/11/63	220	2,0	T4	BW	TiCN	227.275.722P
275	32	2/8/45+2/9/50+2/11/63	220	2,5	T4	BW	TiCN	227.275.720P
300	32	2/8/45+2/9/50+2/11/63	220	2,0	T4	BW	TiCN	227.300.722P
300	32	2/8/45+2/9/50+2/11/63	220	2,5	T4	BW	TiCN	227.300.720P
315	32	2/8/45+2/9/50+2/11/63	240	2,5	T4	BW	TiCN	227.315.740P
350	32	2/8/45+2/9/50+2/11/63	280	2,5	T4	BW	TiCN	227.350.780P



227 HSS LINE



METAL & STEEL

D mm	B mm	PIN HOLE	Z	K mm	β	COATING	ORDER NO.
200	32	2/8/45+2/9/50+2/11/63	0	1,8	Not Sharpened	VAPO	227.200P
225	32	2/8/45+2/9/50+2/11/63	0	1,9	Not Sharpened	VAPO	227.225P
250	32	2/8/45+2/9/50+2/11/63	0	2,0	Not Sharpened	VAPO	227.250P
275	32	2/8/45+2/9/50+2/11/63	0	2,5	Not Sharpened	VAPO	227.275P
300	32	2/8/45+2/9/50+2/11/63	0	2,5	Not Sharpened	VAPO	227.300P
315	32	2/8/45+2/9/50+2/11/63	0	2,5	Not Sharpened	VAPO	227.315P
350	32	2/8/45+2/9/50+2/11/63	0	2,5	Not Sharpened	VAPO	227.350P



226 INDUSTRIAL

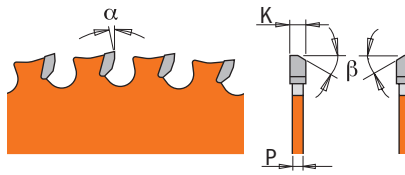

METAL & STEEL

Machines



Blade diameter compatibility is contingent on machine type.

Materials

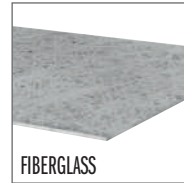
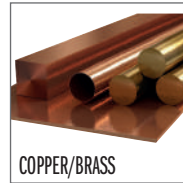
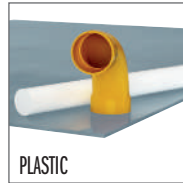

D mm	B mm	PIN HOLE	Z	K mm	P mm	α	β	MAX RPM		ORDER NO.
136	20 (+10)	-	56	1,5	1,2	0°	8° FWF	6000	10	226.136.56H
150	20	-	60	1,6	1,2	0°	8° FWF	6000	10	226.150.60H
160	20 (+16)	2/6/32	60	2,0	1,6	0°	8° FWF	6000	10	226.160.60H ●
165	20	2/6/32	60	1,6	1,2	0°	8° FWF	6000	10	226.165.60H
184	30 (+16+20)	2/7/42	64	2,0	1,6	0°	8° FWF	6000	10	226.184.64M
190	30 (+20)	2/7/42	64	2,0	1,6	0°	8° FWF	6000	10	226.190.64M
210	30	2/7/42	64	2,2	1,8	0°	8° FWF	4500	10	226.210.64M ●
216	30	2/7/42	64	2,2	1,8	0°	8° FWF	3500	10	226.216.64M ●
254	15,87	-	60	2,2	1,8	0°	8° FWF	3000	5	226.060.10
254	30	COMBI3	60	2,2	1,8	0°	8° FWF	3000	5	226.060.10M
305	25,4	-	80	2,2	1,8	0°	8° FWF	2000	5	226.080.12
305	30	COMBI3	80	2,2	1,8	0°	8° FWF	2000	5	226.080.12M
355	25,4	-	90	2,2	1,8	0°	8° FWF	2000	5	226.090.14
355	30	COMBI3	90	2,2	1,8	0°	8° FWF	2000	5	226.090.14M

● Ideal for FESTOOL®

226 INDUSTRIAL

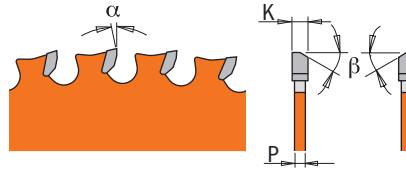

METAL & STEEL

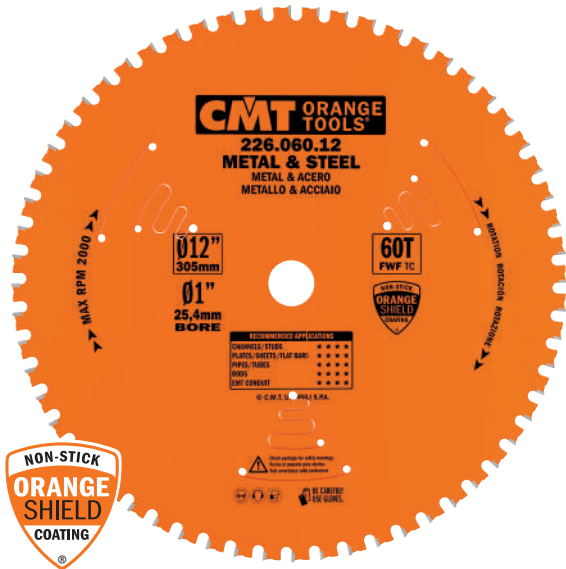

Machines



Blade diameter compatibility is contingent on machine type.

Materials



D mm	B mm	PIN HOLE	Z	K mm	P mm	α	β	MAX RPM		ORDER NO.
136	10	-	30	1,5	1,2	0°	8° FWF	6000	10	226.030.05
136	20	-	30	1,5	1,2	0°	8° FWF	6000	10	226.030.05H
150	20	-	32	1,6	1,2	0°	8° FWF	6000	10	226.032.06H
160	20	2/6/32	30	2,0	1,6	0°	8° FWF	6000	10	226.030.06H ●
165	15,87	-	36	1,6	1,2	0°	8° FWF	6000	10	226.036.06
165	20	2/6/32	36	1,6	1,2	0°	8° FWF	6000	10	226.036.06H
165	30	2/7/42	36	1,6	1,2	0°	8° FWF	6000	10	226.036.06M
184	15,87	-	48	2,0	1,6	0°	8° FWF	6000	10	226.048.07
190	30	2/7/42	40	2,0	1,6	0°	8° FWF	6000	10	226.040.07M
203	15,87	-	48	2,2	1,8	0°	8° FWF	4500	10	226.048.08
210	30	2/7/42	48	2,2	1,8	0°	8° FWF	4500	10	226.048.08M ●
216	30	2/7/42	48	2,2	1,8	0°	8° FWF	3500	10	226.047.09M ●
235	30	2/7/42	48	2,2	1,8	0°	8° FWF	3500	10	226.048.09M
254	15,87	-	48	2,2	1,8	0°	8° FWF	3000	5	226.048.10
305	25,4	-	60	2,2	1,8	0°	8° FWF	2000	5	226.060.12
355	25,4	-	72	2,2	1,8	0°	8° FWF	2000	5	226.072.14

● Ideal for FESTOOL®



226 INDUSTRIAL



METAL & STEEL

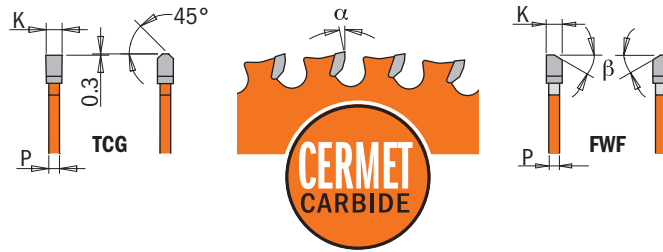

Machines



Blade diameter compatibility is contingent on machine type.

Materials



Suggested for Stainless steel of common use, such as 302, 303 and 304. With higher degrees of hardness, performance is not guaranteed (e.g. 316)

D mm	B mm	PIN HOLE	Z	K mm	P mm	α	β	MAX RPM		ORDER NO.
160	20	2/6/32	40	1,8	1,4	0°	TCG	6000	10	226.540.06H ●
184	15,87	-	48	2,0	1,6	0°	TCG	6000	10	226.548.07
190	30	2/7/42	48	1,8	1,4	0°	TCG	6000	10	226.548.07M
216	30	2/7/42	56	1,8	1,4	0°	TCG	3500	10	226.556.09M ●
250	30	COMBI3	72	2,2	1,8	0°	10° FWF	3000	5	226.572.10M
254	15,87	-	72	2,2	1,8	0°	10° FWF	3000	5	226.572.10
300	30	COMBI3	80	2,2	1,8	0°	10° FWF	2000	5	226.580.12M
305	25,4	-	80	2,2	1,8	0°	10° FWF	2000	5	226.580.12
355	25,4	-	90	2,2	1,8	0°	10° FWF	2000	5	226.590.14
355	30	COMBI3	90	2,2	1,8	0°	10° FWF	2000	5	226.590.14M

● Ideal for FESTOOL®



223 INDUSTRIAL



MULTI-MATERIALS

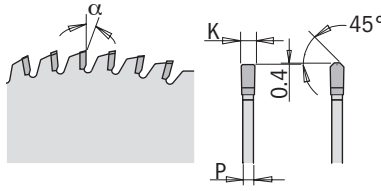

Machines



Blade diameter compatibility is contingent on machine type.

Materials



D mm	B mm	PIN HOLE	Z	K mm	P mm	α	β		ORDER NO.
160	20	2/6/32	48	2,2	1,6	0°	MTCG	5	223.048.06H
250	30	COMBI3	72	3,2	2,5	0°	MTCG	1	223.072.10M
300	30	COMBI3	84	3,2	2,5	0°	MTCG	1	223.084.12M



222 INDUSTRIAL



MULTI-MATERIALS

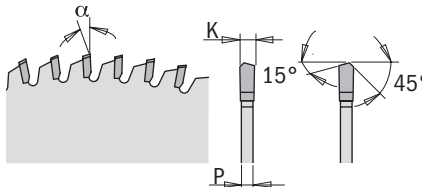

Machines



Blade diameter compatibility is contingent on machine type.

Materials



D mm	B mm	PIN HOLE	Z	K mm	P mm	α	β		ORDER NO.
250	30	COMBI3	80	2,8	2,2	-3° Neg.	MATB	1	222.080.10M
300	30	COMBI3	96	2,8	2,2	-3° Neg.	MATB	1	222.096.12M



230.5

CMT designed a new Dado Precision Set with the following features:

- New Setting Points for chippers alignment.
- For flat bottom grooves & virtually splinter-free cuts in solid wood, laminates & melamines, veneer plywood.
- Includes shims (plastic & magnetic) and plastic "lock spacers" set for micro-thin adjustability.
- Orange Shield Coating protect from heat, guming and corrosion.



WOOD

NOT FOR EU

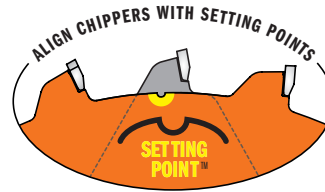

Always use both outside blades. Never use the chippers by themselves, or with only one outside blade. Securely fasten CMT Dado on machine using manufacturer's recommended dado arbor nut.

Materials



Machines



SET INCLUDES:

- A - Left Outside Blade (qty: 1)
- B - Right Outside Blade (qty: 1)
- C - Chippers 1/8" (qty: 4)
- D - Spacers 1/16" (qty: 2)
- E - Shims 0.004" (qty: 5)
- F - Shim 0.008" (qty: 1)
- G - Shim 0.012" (qty: 1)
- H - Shim 0.020" (qty: 1)

SPARE PART SET: 299.000.02

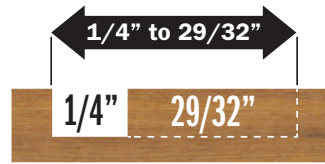
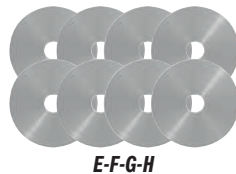
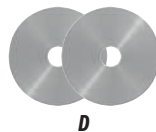
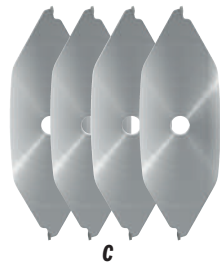

Download instructions sheets from our website

Nominal Widths	1/4"	5/16"	11/32"	3/8"	13/32"	7/16"	15/32"	1/2"	17/32"	9/16"	19/32"	5/8"	21/32"	11/16"	23/32"	3/4"	25/32"	13/16"	27/32"	7/8"	29/32"		
Left Blade	•	•	•	•	•	•	•	•	•	•	•	•	•	•	•	•	•	•	•	•	•	•	
Right Blade	•	•	•	•	•	•	•	•	•	•	•	•	•	•	•	•	•	•	•	•	•	•	
Chipper 1/8"	0	0	0	1	1	1	2	2	2	2	3	3	3	3	4	4	4	4	4	4	4	4	
Spacer 1/16"	0	1	1	0	0	1	1	0	0	1	1	0	0	1	1	0	0	1	1	2	2	2	
Shim 0.004"	1	1	0	0	1	0	1	0	0	0	0	0	0	0	0	0	0	0	1	0	1	0	1
Shim 0.008"	0	0	1	0	1	0	1	1	1	1	1	1	1	1	1	1	1	1	1	1	1	1	1
Shim 0.012"	0	0	1	0	1	0	1	0	1	0	1	0	1	0	1	0	1	0	1	1	1	1	1
Shim 0.020"	0	0	1	0	1	0	1	0	1	0	1	0	1	0	1	0	1	0	1	0	1	0	1

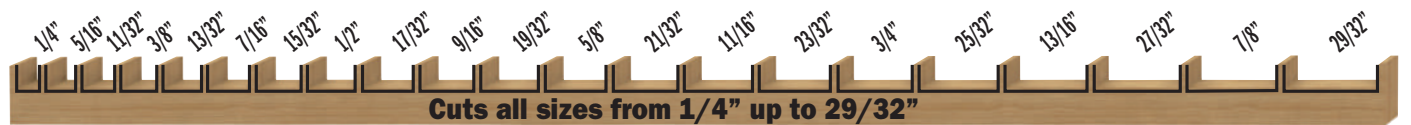

230.520.06

Sturdy reusable carrying case



230.524.08

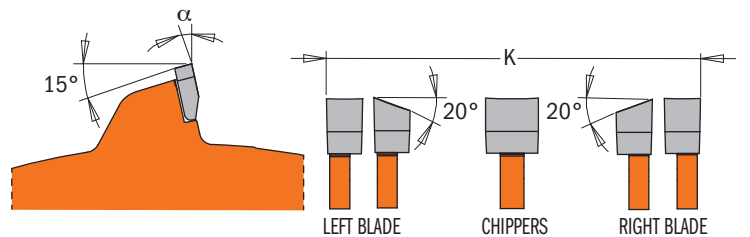

D mm	B mm	Z	α	β		ORDER NO.
152	15,87	20	-12° Neg.	FLAT+ATB	3	230.520.06
203	15,87	24	-12° Neg.	FLAT+ATB	3	230.524.08

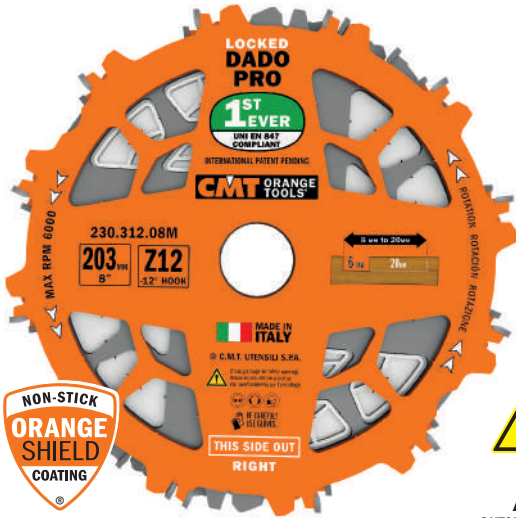

230.312 INTERNATIONAL PATENT PENDING

CMT is proud to introduce a brand new Locked Dado Pro Set unlike any other! This is the very first Dado ever deemed UNI EN847 compliant. This means that while the Dado is rotating, the assembled elements will never come into contact with each other! This is possible thanks to unique blade body design and 'never before seen' special "lock spacers".

- FEATURES:**
- For flat bottom grooves & virtually splinter-free cuts in solid wood, laminates & melamines, veneer plywood.
 - Orange Shield Coating protect from heat, gumming and corrosion.
 - Includes shims (plastic & magnetic) and plastic "lock spacers" set for micro-thin adjustability.

! Always use both outside blades. Never use the chippers by themselves, or with only one outside blade. Securely fasten CMT Dado on machine using manufacturer's recommended dado arbor nut.



WOOD

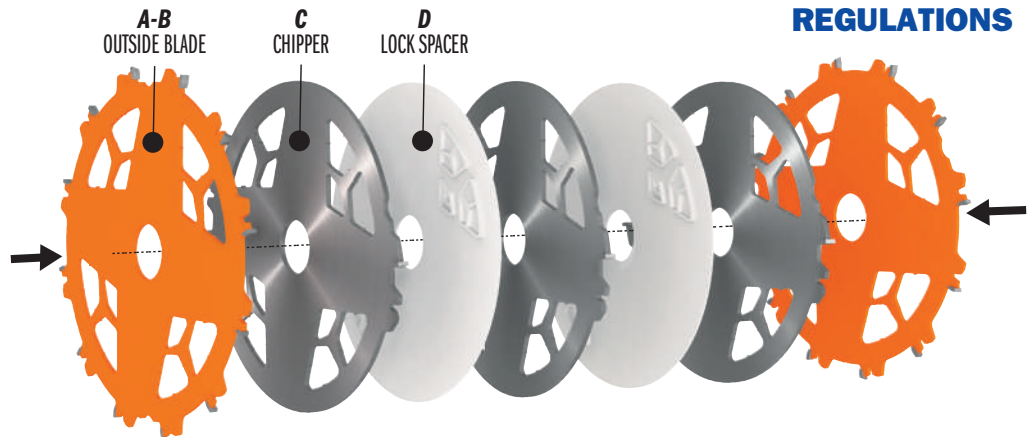
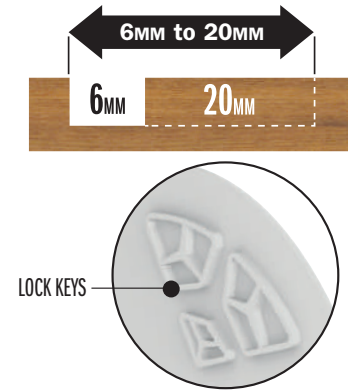

Materials



Machines



Sturdy reusable carrying case

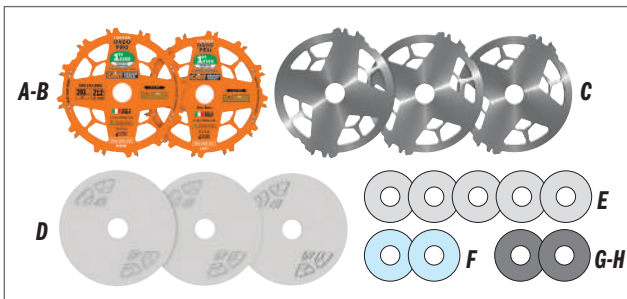

- SET INCLUDES:**
- A** - Left Outside Blade 203mm (qty: 1)
 - B** - Right Outside Blade 203mm (qty: 1)
 - C** - Chippers 3.14mm (qty: 3)
 - D** - Lock Spacers 1.6mm (qty: 3)
 - E** - Shim 0.1mm (qty: 5)
 - F** - Shim 0.2mm (qty: 2)
 - G** - Magnetic Shim 0.3mm (qty: 1)
 - H** - Magnetic Shim 0.5mm (qty: 1)
- SPARE PART SET**

! INSTRUCTIONS ON FRONT & BACK OF INSERT MUST BE USED TOGETHER



Download instructions sheets from our website

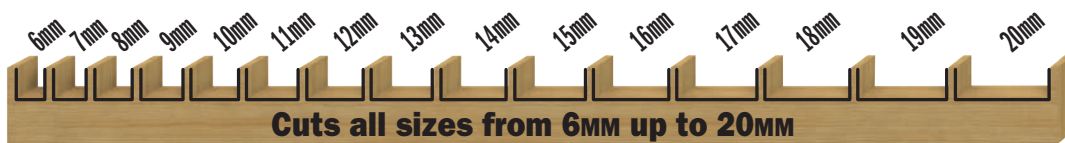

Nominal Widths	6mm	7mm	8mm	9mm	10mm	11mm	12mm	13mm	14mm	15mm	16mm	17mm	18mm	19mm	20mm
Left Blade	•	•	•	•	•	•	•	•	•	•	•	•	•	•	•
Right Blade	•	•	•	•	•	•	•	•	•	•	•	•	•	•	•
Chipper 3.14mm	0	0	0	0	1	1	1	2	2	2	2	3	3	3	3
Lock Spacer 1.6mm	0	0	1	1	0	1	1	0	1	1	2	0	1	2	2
Shim 0.1mm	0	0	0	2	1	0	0	0	1	1	0	4	0	0	2
Shim 0.2mm	0	1	2	2	1	1	2	1	0	1	1	2	1	2	2
Mag. Shim 0.3mm	0	1	0	1	0	0	1	0	0	1	1	1	1	0	1
Mag. Shim 0.5mm	0	1	0	1	1	0	1	1	0	1	0	1	1	0	1

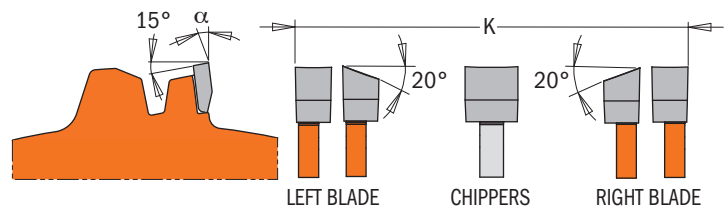

D mm	B mm	Z	α	β	ORDER NO.
203	15,87	12	-12° Neg.	FLAT+ATB	3 230.312.08
203	30	12	-12° Neg.	FLAT+ATB	3 230.312.08M

Spare parts: 299.000.08 Dado Pro Shim Set 230.312.08M
299.000.09 Dado Pro Shim Set 230.312.08



240 INDUSTRIAL

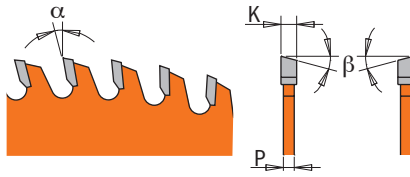

WOOD

Machines



TOUPIE



CHUCK CNC

Blade diameter compatibility is contingent on machine type.

Suitable for these CNC chucks:



183.410.30



183.420.30

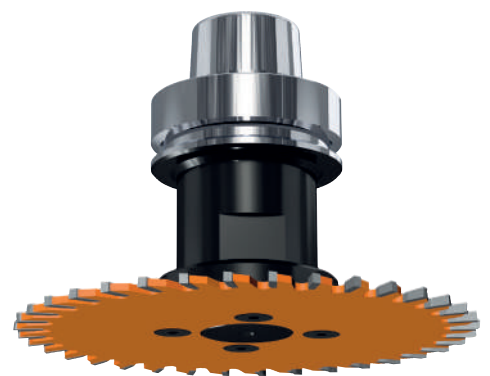

Applications



GROOVING



CROSS

Materials



WOOD



PLYWOOD



MELAMINE

D mm	B mm	PIN HOLE 	Z	K mm	P mm	α	β		ORDER NO.
150	30	4/6,5 - 12/48 45°	36	3,0	2,2	5°	5°ATB	10	240.150.030M
150	30	4/6,5 - 12/48 45°	36	4,0	3,0	5°	5°ATB	10	240.150.040M
150	30	4/6,5 - 12/48 45°	36	5,0	3,0	5°	5°ATB	10	240.150.050M
150	30	4/6,5 - 12/48 45°	36	6,0	3,0	5°	5°ATB	10	240.150.060M



240 INDUSTRIAL



WOOD

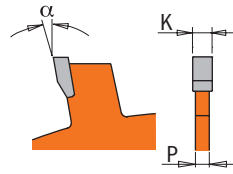

The new design allows blades stacking with different kerf thickness (see examples of stacking).

Machines



TOUPIE



CHUCK CNC

Blade diameter compatibility is contingent on machine type.

Applications



GROOVING/STACKING

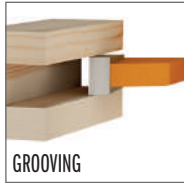

GROOVING

Materials



WOOD



PLYWOOD



MELAMINE



D mm	B mm	PIN HOLE	Z	K mm	P mm	α	β		ORDER NO.
150	30	-	12	2,0	1,4	15°	FLAT	10	240.020.06M
150	35	-	12	2,0	1,4	15°	FLAT	10	240.020.06R
150	30	-	12	3,0	2,0	15°	FLAT	10	240.030.06M
150	35	-	12	3,0	2,0	15°	FLAT	10	240.030.06R
150	30	-	12	4,0	3,0	15°	FLAT	10	240.040.06M
150	35	-	12	4,0	3,0	15°	FLAT	10	240.040.06R
150	30	-	12	5,0	3,0	15°	FLAT	10	240.050.06M
150	35	-	12	5,0	3,0	15°	FLAT	10	240.050.06R
150	30	-	12	6,0	3,0	15°	FLAT	10	240.060.06M
150	35	-	12	6,0	3,0	15°	FLAT	10	240.060.06R
180	30	-	18	3,0	2,0	15°	FLAT	10	240.030.07M
180	35	-	18	3,0	2,0	15°	FLAT	10	240.030.07R
180	30	-	18	4,0	3,0	15°	FLAT	10	240.040.07M
180	35	-	18	4,0	3,0	15°	FLAT	10	240.040.07R
180	30	-	18	5,0	3,0	15°	FLAT	10	240.050.07M
180	35	-	18	5,0	3,0	15°	FLAT	10	240.050.07R
180	30	-	18	6,0	3,0	15°	FLAT	10	240.060.07M
180	35	-	18	6,0	3,0	15°	FLAT	10	240.060.07R

Grooving System

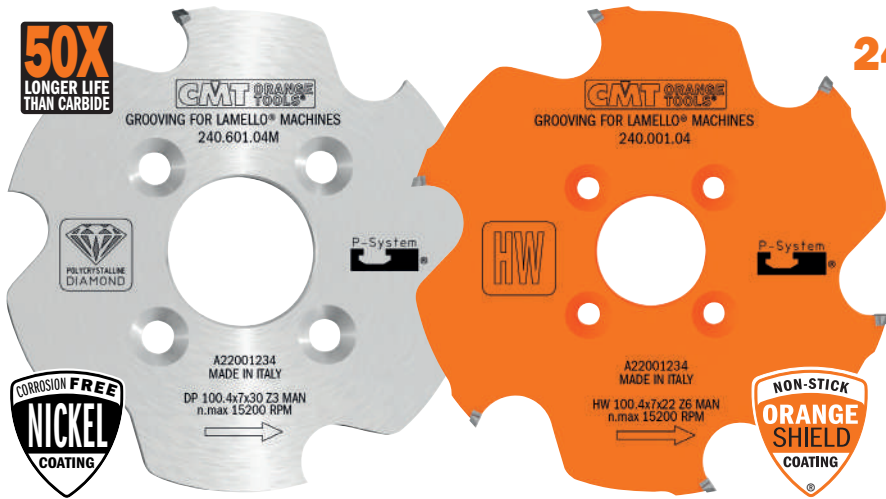

240 XTREME



WOOD

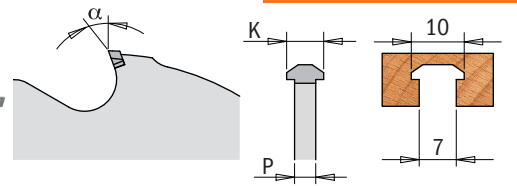

Applications

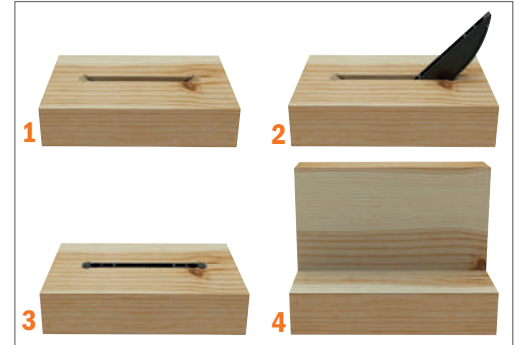

Machines

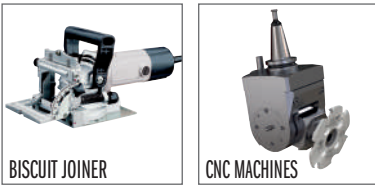

Materials

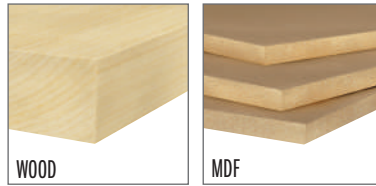

D mm	B mm	TEETH MATERIAL	MACHINE	PIN HOLE	Z	K mm	P mm	α	β	COATING TYPE		ORDER NO.
100,4	22	HW	LAMELLO® ZETA P®	4/4,5 - 9,5/36	6	7	4	20°	TCG	ORANGE SHIELD	10	240.001.04
100,4	22	DP	LAMELLO® ZETA P®	4/4,5 - 9,5/36	3	7	4	20°	TCG	NICKEL	10	240.601.04
100,4	30	DP	CNC	4/6,6 - 12/48	3	7	4	20°	TCG	NICKEL	10	240.601.04M

Biscuit Joiner



240-241 INDUSTRIAL



WOOD

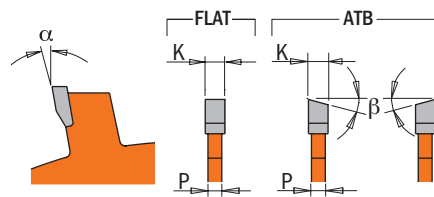

Machines



Applications

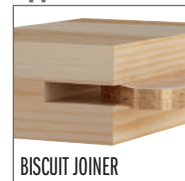

Materials

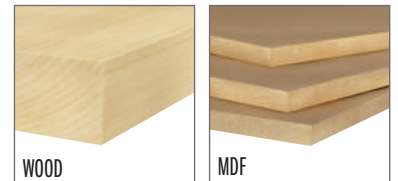

D mm	B mm	PIN HOLE	Z	K mm	P mm	α	β		ORDER NO.
100	22	4/4,5 - 9,5/36	6	3,96	3,0	18°	10°ATB	10	240.006.04
100	22	4/4,5 - 9,5/36	8	3,96	3,0	15°	10°ATB	10	240.008.04
100	22	-	8	3,96	3,1-3,8	15°	FLAT	10	241.008.04 ●

● Ideal for VIRUTEX®



240.004.04 **EXTREME**



PERFORMANCE

WOOD

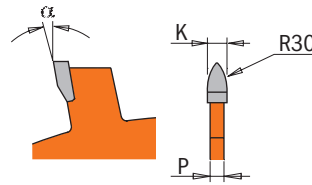

Machines



BISCUIT JOINER

Applications



PATCHWORK AND REPAIR

Materials



HARDWOOD



SOFTWOOD

D mm	B mm	MACHINE	Z	K mm	P mm	α	β		ORDER NO.
100	22	LAMELLO®	4	8,0	6,0	18°	R30	10	240.004.04

Clearing grass, bushes, small trees



298 ITK PLUS®



PERFORMANCE
MULTI-MATERIALS

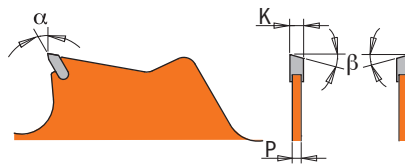

SECURED TOOTH

SECURED TOOTH - MORE RESISTANT TO ACCIDENTAL CONTACT

Teeth are welded deep inside blade body which significantly reduces breakage caused by accidental contact with terrain, rocks or stones, masonry work, metal parts, etc.; avoid all contact with these elements wherever possible.

HEAVY DUTY PLATE - THIN, LIGHT AND STRONG

Cut from the finest steel. Remarkably thin kerf and specifically designed perforations considerably reduce blade weight thereby reducing tool workload.

SAFETY WARNING

Circular saw blades are suitable for thinning brush and cutting small trees up to a diameter of 5 cm (2 in) in thickness. Do not attempt to cut trees with larger diameters, since the blade may catch or jerk the clearing saw forward. This may cause damage to the blade or loss of control of the power tool and result in serious injury. Use a chain saw for such work. The operator shall ensure, while working, that no persons or animals come within 15 meters (50 feet) of the tool while in operation. Inspect the work area: remove stones, rocks, pieces of metal and other solid objects which could be thrown by the cutting attachment causing damage to objects or injury to those in close proximity. To reduce the risk of blade/teeth breakage, avoid all contact with terrain, rocks or stones, masonry work, metal parts, etc.



Machines



BRUSH CUTTER

Materials



BUSHES & SMALL TREES (up to a diameter of Ø5 cm)



GRASS

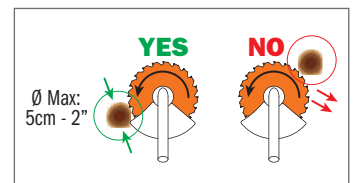
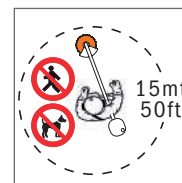

D mm	B mm	RPM max	Z	K mm	P mm	α	β		ORDER NO.
250	25,4 (+20)	12.000	20	2,0	1,4	2°	8° ATB	10	298.250.20
250	25,4 (+20)	12.000	40	2,0	1,4	2°	8° ATB	10	298.250.40

Calibration & Sanding Disks



299.11

If you're looking for fast and easy saw alignment and balancing, the cut calibration and sanding disk is for you. First, mount your calibration and sanding disk in your table saw and line it up with a square for accuracy. Then, remove the calibration and sanding disk and mount your saw blade for true precise cuts. You can also use the calibration and sanding disk as a sander by simply attaching self-stick sandpaper and installing the disk in your table saw.



D mm	B mm	P mm		ORDER NO.
200	30	2,8	10	299.111.00M
250	30	2,8	10	299.112.00M

Saw Blades Stabilizers



299.10

The CMT blade stabilizer virtually eliminates rim vibration to make cleaner, straighter cuts and extend the life of your CMT saw blade. It also helps lessen noise caused by vibration during cutting.



DESCRIPTION	D mm	B mm	P mm		ORDER NO.
Stabilizer (2 pcs.) for Ø200mm	75	30	3,0	5	299.101.00M
Stabilizer (2 pcs.) for Ø250mm	125	30	3,0	5	299.102.00M
Stabilizer (2 pcs.) for Ø300mm	152	30	3,0	5	299.103.00M

Note: for use on stationary saws only. Each order includes 2 stabilizers.

Reduction Rings for Saw Blades

299

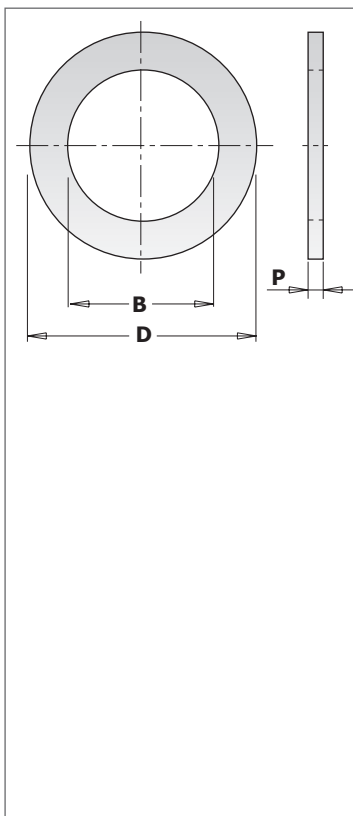

D mm	B mm	P mm		ORDER NO.	D mm	B mm	P mm		ORDER NO.
15,87	10	1,2	10	299.218.00	30	15,87	2,0	10	299.303.00
15,87	12,7	1,2	10	299.217.00	30	16	1,2	10	299.451.00
20	12,7	1,2	10	299.221.00	30	16	1,4	10	299.223.00
20	12,7	1,6	10	299.401.00	30	16	2,0	10	299.226.00
20	13	1,6	10	299.402.00	30	18	1,4	10	299.232.00
20	15	1,6	10	299.403.00	30	19,05	1,4	10	299.241.00
20	15,87	1,4	10	299.243.00	30	19,05	2,0	10	299.305.00
20	16	1,0	10	299.351.00	30	20	1,2	10	299.452.00
20	16	1,2	10	299.222.00	30	20	1,4	10	299.224.00
20	16	1,6	10	299.404.00	30	20	2,0	10	299.227.00
20	18	1,4	10	299.236.00	30	22	1,4	10	299.231.00
22,2	15	1,4	10	299.237.00	30	25	1,2	10	299.453.00
22,2	16	1,4	10	299.242.00	30	25	1,4	10	299.225.00
22,2	20	1,4	10	299.238.00	30	25	2,0	10	299.228.00
25	16	2,0	10	299.301.00	30	25,4	1,6	10	299.405.00
25	20	2,0	10	299.302.00	30	25,4	2,0	10	299.212.00
25,4	15,87	1,4	10	299.216.00	32	20	2,0	10	299.309.00
25,4	19,05	1,4	10	299.213.00	32	30	2,0	10	299.229.00
25,4	20	1,4	10	299.214.00	35	20	2,0	10	299.311.00
25,4	20	2,3	10	299.220.00	35	25	2,0	10	299.312.00
25,4	22	1,4	10	299.215.00	35	25,4	2,0	10	299.313.00
25,4	22,2	1,4	10	299.239.00	35	30	2,0	10	299.230.00
25,4	22,2	2,3	10	299.219.00	35	32	2,0	10	299.233.00
30	15	1,4	10	299.240.00	40	30	2,0	10	299.316.00
30	15,87	1,4	10	299.211.00					

D mm	B mm	MATERIALS/APPLICATION	Z	K mm	P mm	α	β	ORDER NO.	PAGE
50	10	WOOD	20	1,1	0,8	15°	10° ATB	273.050.20D	31
70	20	WOOD	8+8	2,8-3,6		12°	FLAT	289.070.16H	44
80	10	WOOD	36	1,6	1,0	15°	10° ATB	273.080.36D	31
80	20	WOOD	12	3,1-3,6	2,2	10°	CO+FLAT	S288.080.12H	45
80	20	WOOD	10+10	2,8-3,6		12°	FLAT	289.080.20H	44
85	15	MULTI-MATERIALS	6	1,8	1,4	12°	TCG	236.085.06G	10
85	15	WOOD	24	1,1	0,7	12°	5° ATB	K02403	12
100	20	WOOD	20	3,1-4,0	2,2	5°	CO+5° ATB	288.100.20H	45
100	20	WOOD	10+10	2,8-3,6		12°	FLAT	289.100.20H	44
100	22	WOOD	4	8	6	18°	R30	240.004.04	63
100	22	WOOD	6	3,96	3	18°	10° ATB	240.006.04	63
100	22	WOOD	8	3,96	3	15°	10° ATB	240.008.04	63
100	22	WOOD	8	3,96	3,1-3,8	15°	FLAT	241.008.04	63
100	22	WOOD	20	3,1-4,0	2,2	5°	CO+5° ATB	288.100.20K	45
100	22	WOOD	10+10	2,8-3,6		12°	FLAT	289.100.20K	44
100,4	22	WOOD	3	7	4	20°	TCG	240.601.04	62
100,4	22	WOOD	6	7	4	20°	TCG	240.001.04	62
100,4	30	WOOD	3	7	4	20°	TCG	240.601.04M	62
115	9,5	WOOD	24	1,5	1,0	20°	10° ATB + 8° Shear	272.115.24	27
120	20	WOOD	18	1,8	1,2	15°	15° ATB	291.120.18H	22
120	20	WOOD	20	3,1-3,7	2,2	5°	CONICAL	238.120.20H	46
120	20	WOOD	24	3,1-4,0	2,2	5°	CO+5° ATB	288.120.24H	45
120	20	WOOD	24	3,4-4,2	2,5	5°	CO+5° ATB	288.120.24H1	45
120	20	NON-FERROUS	36	1,8	1,2	-6° Neg.	TCG	296.120.36H	50
120	20	WOOD	40	1,8	1,2	10°	15° ATB	292.120.40H	26
120	20	WOOD	12+12	2,8-3,6		12°	FLAT	289.120.24H	44
120	22	WOOD	24	3,1-4,0	2,2	5°	CO+5° ATB	288.120.24K	45
120	22	WOOD	12+12	2,8-3,6		12°	FLAT	289.120.24K	44
120	50	WOOD	12+12	2,8-3,6		12°	FLAT	289.120.24T	44
125	20	WOOD	20	2,4	1,4	15°	15° ATB	291.125.20H	22
125	20	WOOD	20	3,1-3,7	2,2	5°	CONICAL	238.125.20H	46
125	20	WOOD	24	3,1-4,0	2,2	5°	CO+5° ATB	288.125.24H	45
125	20	WOOD	24	3,4-4,2	2,5	5°	CO+5° ATB	288.125.24H1	45
125	20	WOOD	24	4,3-5,5	3,2	10°	CO+FLAT	288.125.24H2	45
125	20	WOOD	36	2,4	1,4	15°	15° ATB	292.125.36H	26
125	20	WOOD	12+12	2,8-3,6		12°	FLAT	289.125.24H	44
125	22	WOOD	24	3,1-4,0	2,2	5°	CO+5° ATB	288.125.24K	45
125	22	WOOD	12+12	2,8-3,6		12°	FLAT	289.125.24K	44
125	22,2	MULTI-MATERIALS	7	2	1,4	5°	TCG	236.125.07	10
125	45	WOOD	24	4,3-5,5	3,2	10°	CO+FLAT	288.125.24Q	45
130	20	WOOD	20	2,4	1,4	15°	15° ATB	291.130.20H	22
130	20	WOOD	36	2,4	1,4	15°	15° ATB	292.130.36H	26
136	10	METAL & STEEL	30	1,5	1,2	0°	8° FWF	226.030.05	55
136	20	WOOD	18	1,5	1	15°	15° ATB	K13618H-X10	12
136	20	METAL & STEEL	30	1,5	1,2	0°	8° FWF	226.030.05H	55
136	20 (+10)	WOOD	18	1,5	1,0	20°	10° ATB + 8° Shear	271.136.18H	23
136	20 (+10)	WOOD	36	1,5	1,0	18°	10° ATB + 8° Shear	272.136.36H	27
136	20 (+10)	METAL & STEEL	56	1,5	1,2	0°	8° FWF	226.136.56H	54
140	16	WOOD	24	3,1-4,0	2,2	10°	CO+FLAT	Y288.140.24E	45
140	20	WOOD	20	2,4	1,4	15°	15° ATB	291.140.20H	22
140	20	WOOD	24	1,8	1,2	15°	15° ATB + 8° Shear	271.140.24H	23
140	20	WOOD	36	2,4	1,4	15°	15° ATB	292.140.36H	26
140	20	WOOD	42	1,8	1,2	5°	15° ATB + 8° Shear	272.140.42H	27
140	20	NON-FERROUS	48	1,8	1,2	-6° Neg.	TCG	276.140.48H	51
150	16	WOOD	24	2,4	1,4	15°	15° ATB	291.150.24E	22
150	20	WOOD	12	2,4	1,4	20°	10° ATB	290.150.12H	18
150	20	METAL & STEEL	32	1,6	1,2	0°	8° FWF	226.032.06H	55
150	20	WOOD	40	2,4	1,4	15°	15° ATB	292.150.40H	26
150	20	METAL & STEEL	60	1,6	1,2	0°	8° FWF	226.150.60H	54
150	30	WOOD	12	2	1,4	15°	FLAT	240.020.06M	61

Saw Blade Index

D mm	B mm	MATERIALS/APPLICATION	Z	K mm	P mm	α	β	ORDER NO.	PAGE
150	30	WOOD	12	3	2	15°	FLAT	240.030.06M	61
150	30	WOOD	36	3	2,2	5°	5°ATB	240.150.030M	60
150	30	WOOD	36	4	3	5°	5°ATB	240.150.040M	60
150	30	WOOD	36	5	3	5°	5°ATB	240.150.050M	60
150	30	WOOD	36	6	3	5°	5°ATB	240.150.060M	60
150	30	WOOD	48	3,2	2,2	5°	15° ATB	285.048.06M	26
150	30	WOOD	12	4	3	15°	FLAT	240.040.06M	61
150	30	WOOD	12	5	3	15°	FLAT	240.050.06M	61
150	30	WOOD	12	6	3	15°	FLAT	240.060.06M	61
150	35	WOOD	12	2	1,4	15°	FLAT	240.020.06R	61
150	35	WOOD	12	3	2	15°	FLAT	240.030.06R	61
150	35	WOOD	12	4	3	15°	FLAT	240.040.06R	61
150	35	WOOD	12	5	3	15°	FLAT	240.050.06R	61
150	35	WOOD	12	6	3	15°	FLAT	240.060.06R	61
150	20 (+16)	WOOD	24	1,5	1	18°	10° ATB + 8° Shear	271.150.24H	23
150	20 (+16)	WOOD	24	2,4	1,4	15°	15° ATB	291.150.24H	22
150	20 (+16)	WOOD	40	1,5	1	16°	10° ATB + 8° Shear	272.150.40H	27
152	15,87	WOOD	20			-12° Neg.	FLAT+ATB	230.520.06	58
160	16	WOOD	12	2,2	1,6	20°	10° ATB	290.160.12E	18
160	20	MULTI-MATERIALS	4	2,4	1,8	12°	TCG	236.160.04H	10
160	20	MULTI-MATERIALS	10	2,4	1,8	5°	TCG	236.160.10H	10
160	20	MULTI-MATERIALS	20	2,2	1,6	10°	HR	235.160.20H	47
160	20	WOOD	24	2,2	1,4	15°	15° ATB	K16024H-X10	12
160	20	WOOD	24	2,2	1,6	15°	15° ATB	291.160.24H	22
160	20	NON-FERROUS	24	2,2	1,6	5°	TCG	284.160.24H	48
160	20	WOOD	28	2,2	1,6	15°	10° ATB	285.160.28H	22
160	20	METAL & STEEL	30	2	1,6	0°	8° FWF	226.030.06H	55
160	20	WOOD	34	2,6	1,8	10°	HDF	287.034.06H	37
160	20	WOOD	40	2,2	1,4	10°	15° ATB	K16040H-X10	12
160	20	WOOD	40	2,2	1,6	10°	15° ATB	292.160.40H	26
160	20	NON-FERROUS	40	2,2	1,6	-6° Neg.	TCG	296.160.40H	50
160	20	WOOD	48	2,2	1,6	5°	15° ATB	285.160.48H	26
160	20	WOOD	48	2,2	1,6	5°	12° ATB	285.760.48H	28
160	20	WOOD	48	2,2	1,6	4°	TCG	281.760.48H	39
160	20	WOOD	48	2,2	1,6	5°	TCG	281.160.48H	42
160	20	MULTI-MATERIALS	48	2,2	1,6	0°	MTCG	223.048.06H	57
160	20	NON-FERROUS	52	2,2	1,8	-5° Neg.	TCG	296.760.52H	49
160	20	WOOD	56	2,2	1,6	15°	15° ATB	292.160.56H	30
160	20	WOOD	56	2,2	1,6	-3° Neg.	TCG	281.161.56H	42
160	20	NON-FERROUS	56	2,2	1,6	-6° Neg.	TCG	296.160.56H	50
160	30	WOOD	40	2,2	1,6	10°	15° ATB	292.160.40M	26
160	45	WOOD	36	4,3-5,5	3,2	10°	CO+FLAT	288.160.36Q	45
160	55	WOOD	36	4,3-5,5	3,2	10°	CO+FLAT	288.160.36Q	45
160	20	METAL & STEEL	40	1,8	1,4	0°	TCG	226.540.06H	56
160	20 (+16)	METAL & STEEL	60	2	1,6	0°	8° FWF	226.160.60H	54
160	20 (+16)	WOOD	12	2,2	1,6	20°	10° ATB	290.160.12H	18
160	20 (+16)	WOOD	24	1,8	1,2	18°	10° ATB + 8° Shear	271.160.24H	23
160	20 (+16)	WOOD	40	1,8	1,2	16°	10° ATB + 8° Shear	272.160.40H	27
160	20 (+16)	NON-FERROUS	48	1,8	1,2	-6° Neg.	TCG	276.160.48H	51
160	20 (+16)	WOOD	56	1,8	1,2	12°	10° ATB + 8° Shear	273.160.56H	31
160	20 (VIRUTEX®)	WOOD	40	2,2	1,6	10°	TCG	281.160.40H	42
160	30(+16)	WOOD	24	2,2	1,6	15°	15° ATB	291.160.24M	22
165	20	WOOD	24	1,7	1,1	15°	15° ATB	K16524H-X10	12
165	20	WOOD	24	2,2	1,6	15°	15° ATB	291.165.24H	22
165	20	METAL & STEEL	36	1,6	1,2	0°	8° FWF	226.036.06H	55
165	20	WOOD	40	2,2	1,6	10°	15° ATB	292.165.40H	26
165	20	NON-FERROUS	40	2,2	1,6	-6° Neg.	TCG	296.165.40H	50
165	20	WOOD	56	2,2	1,6	15°	15° ATB	292.165.56H	30
165	20	WOOD	56	2,2	1,6	-3° Neg.	TCG	281.166.56H	42
165	20	NON-FERROUS	56	2,2	1,6	-6° Neg.	TCG	296.165.56H	50

D mm	B mm	MATERIALS/APPLICATION	Z	K mm	P mm	α	β	ORDER NO.	PAGE
165	20	METAL & STEEL	60	1,6	1,2	0°	8° FWF	226.165.60H	54
165	30	WOOD	24	1,7	1,1	18°	10° ATB + 8° Shear	271.165.24M	23
165	30	WOOD	24	2,6	1,6	15°	15° ATB	291.165.24M	22
165	30	METAL & STEEL	36	1,6	1,2	0°	8° FWF	226.036.06M	55
165	30	WOOD	40	2,6	1,6	10°	15° ATB	292.165.40M	26
165	15,87	METAL & STEEL	36	1,6	1,2	0°	8° FWF	226.036.06	55
165	20 (+15,87)	MULTI-MATERIALS	4	1,8	1,4	12°	TCG	236.165.04H	10
165	20 (+15,87)	MULTI-MATERIALS	10	1,8	1,4	5°	TCG	236.165.10H	10
165	20 (+15,87)	WOOD	24	1,7	1,1	18°	10° ATB + 8° Shear	271.165.24H	23
165	20 (+15,87)	WOOD	36	1,7	1,1	20°	10° ATB + 8° Shear	272.165.36H	27
165	20 (+15,87)	WOOD	56	1,6	1	12°	15° ATB + 8° Shear	273.165.56H	31
165	20 (+15,87)	NON-FERROUS	56	1,8	1,2	-6° Neg.	TCG	276.165.56H	51
170	30	WOOD	24	2,6	1,6	20°	10° ATB	291.170.24M	22
170	30	WOOD	40	2,6	1,6	15°	15° ATB	292.170.40M	26
180	20	MULTI-MATERIALS	4	2,4	1,8	12°	TCG	236.180.04H	10
180	20	WOOD	24	2,6	1,6	20°	10° ATB	291.180.24H	22
180	20	WOOD	36	4,3-5,5	3,2	10°	CO+FLAT	Y288.180.36H	45
180	20	WOOD	40	2,6	1,6	15°	15° ATB	292.180.40H	26
180	20	NON-FERROUS	40	2,8	2,2	-6° Neg.	TCG	296.180.40H	50
180	30	WOOD	12	2,6	1,6	20°	10° ATB	290.180.12M	18
180	30	WOOD	24	2,6	1,6	20°	10° ATB	291.180.24M	22
180	30	WOOD	36	4,5-5,5	3,2	10°	CO+FLAT	288.180.36M	45
180	30	WOOD	40	2,6	1,6	15°	15° ATB	292.180.40M	26
180	30	WOOD	56	3,2	2,2	5°	15° ATB	285.056.07M	26
180	30	WOOD	18	3	2	15°	FLAT	240.030.07M	61
180	30	WOOD	18	4	3	15°	FLAT	240.040.07M	61
180	30	WOOD	18	5	3	15°	FLAT	240.050.07M	61
180	30	WOOD	18	6	3	15°	FLAT	240.060.07M	61
180	35	WOOD	18	3	2	15°	FLAT	240.030.07R	61
180	35	WOOD	18	4	3	15°	FLAT	240.040.07R	61
180	35	WOOD	18	5	3	15°	FLAT	240.050.07R	61
180	35	WOOD	18	6	3	15°	FLAT	240.060.07R	61
180	40	WOOD	21+3	2,5	1,8	30	FLAT	280.021.07S	14
180	45	WOOD	36	4,3-5,5	3,2	8°	CO+5° ATB	288.180.36Q2	45
180	45	WOOD	36	4,7-6,0	3,5	10°	CO+FLAT	288.180.36Q	45
180	50	WOOD	44	4,3-5,5	3,2	10°	CO+FLAT	288.180.44T	45
180	55	WOOD	36	5,0-6,2	3,5	10°	CO+FLAT	288.180.360	45
184	15,87	METAL & STEEL	48	2	1,6	0°	8° FWF	226.048.07	55
184	16	WOOD	24	2,6	1,6	20°	10° ATB	291.184.24E	22
184	16	WOOD	40	2,6	1,6	15°	15° ATB	292.184.40E	26
184	30	WOOD	24	1,7	1,1	20°	10° ATB + 8° Shear	271.184.24M	23
184	30	WOOD	24	2,6	1,6	20°	10° ATB	291.184.24M	22
184	30	WOOD	40	1,7	1,1	18°	10° ATB + 8° Shear	272.184.40M	27
184	30	WOOD	40	2,6	1,6	15°	15° ATB	292.184.40M	26
184	15,87	METAL & STEEL	48	2	1,6	0°	TCG	226.548.07	56
184	20 (+16+15,87)	WOOD	24	1,7	1,1	20°	10° ATB + 8° Shear	271.184.24H	23
184	20 (+16+15,87)	WOOD	40	1,7	1,1	18°	10° ATB + 8° Shear	272.184.40H	27
184	20 (+16+15,87)	NON-FERROUS	48	1,8	1,2	-6° Neg.	TCG	276.184.48H	51
184	30 (+16+20)	METAL & STEEL	64	2	1,6	0°	8° FWF	226.184.64M	54
190	16	WOOD	12	2,6	1,6	20°	10° ATB	290.190.12E	18
190	16	WOOD	24	2,6	1,6	20°	10° ATB	291.190.24E	22
190	20	WOOD	12	2,6	1,6	20°	10° ATB	290.190.12H	18
190	20	WOOD	24	2,6	1,6	20°	10° ATB	291.190.24H	22
190	30	MULTI-MATERIALS	4	2,4	1,8	12°	TCG	236.190.04M	10
190	30	MULTI-MATERIALS	12	2,4	1,8	12°	TCG	236.190.12M	10
190	30	WOOD	24	2,2	1,4	20°	10° ATB	K19024M-X10	12
190	30	MULTI-MATERIALS	24	2,5	2	10°	HR	235.190.24M	47
190	30	WOOD	24	2,6	1,6	20°	10° ATB	291.190.24M	22
190	30	NON-FERROUS	30	2,6	2,2	5°	TCG	284.190.30M	48
190	30	METAL & STEEL	40	2	1,6	0°	8° FWF	226.040.07M	55

Saw Blade Index

D mm	B mm	MATERIALS/APPLICATION	Z	K mm	P mm	α	β	ORDER NO.	PAGE
190	30	WOOD	40	2,6	1,6	15°	15° ATB	292.190.40M	26
190	30	NON-FERROUS	40	2,8	2,2	-6° Neg.	TCG	296.190.40M	50
190	30	WOOD	64	2,6	1,6	15°	15° ATB	292.190.64M	30
190	30	NON-FERROUS	64	2,8	2,2	-6° Neg.	TCG	296.190.64M	50
190	30	METAL & STEEL	48	1,8	1,4	0°	TCG	226.548.07M	56
190	30 (+20)	METAL & STEEL	64	2	1,6	0°	8° FWF	226.190.64M	54
190	20 (+16)	WOOD	40	2,6	1,6	15°	15° ATB	292.190.40H	26
190	20 (FESTOOL® FF)	WOOD	32	2,6	1,8	10°	10° ATB	291.190.32FF	22
190	20 (FESTOOL® FF)	WOOD	48	2,4	1,8	10°	15° ATB	292.190.48FF	26
190	20 (FESTOOL® FF)	WOOD	48	2,4	1,8	8°	15° ATB	285.790.48FF	28
190	20 (FESTOOL® FF)	WOOD	54	2,6	1,8	4°	TCG	281.790.54FF	39
190	20 (FESTOOL® FF)	WOOD	54	2,6	1,8	4°	TCG	281.190.54FF	41
190	20 (FESTOOL® FF)	NON-FERROUS	64	2,8	2,2	-6° Neg.	TCG	296.190.64FF	50
190	30 (+20+16)	WOOD	12	2,6	1,6	20°	10° ATB	290.190.12M	18
190	30 (+20+16)	WOOD	24	1,7	1,1	20°	10° ATB + 8° Shear	271.190.24M	23
190	30 (+20+16)	WOOD	42	1,7	1,1	18°	10° ATB + 8° Shear	272.190.42M	27
190	30 (+20+16)	WOOD	64	1,7	1,1	15°	10° ATB + 8° Shear	273.190.64M	31
190	30 (+20+16)	NON-FERROUS	64	1,8	1,2	-6° Neg.	TCG	276.190.64M	51
200	20	WOOD	36	4,4-5,3	3,2	10°	CO+FLAT	288.200.36H	45
200	30	WOOD	24	2,8	1,8	20°	10° ATB	290.200.24M	18
200	30	WOOD	36	1,8	1,2	15°	10° ATB + 8° Shear	271.200.36M	23
200	30	WOOD	36	2,8	1,8	15°	15° ATB	291.200.36M	22
200	30	WOOD	36	3,2	2,2	15°	10° ATB	285.036.08M	22
200	30	WOOD	48	1,8	1,2	15°	10° ATB + 8° Shear	272.200.48M	27
200	30	WOOD	48	2,8	1,8	15°	15° ATB	292.200.48M	26
200	30	NON-FERROUS	48	2,8	2,2	-6° Neg.	TCG	296.200.48M	50
200	30	WOOD	48	3,2	2,2	15°	15° ATB	285.048.08M	26
200	30	WOOD	64	3,2	2,2	5°	15° ATB	285.064.08M	30
200	30	WOOD	64	3,2	2,2	10°	TCG	281.064.08M	42
200	32	METAL & STEEL	0	1,8			Not Sharpened	227.200P	53
200	32	METAL & STEEL	160	1,8			BW	227.200.160P	53
200	40	WOOD	21+3	2,5	1,8	35	FLAT	280.021.08S	14
200	45	WOOD	36	4,3-5,5	3,2	10°	CO+FLAT	Y288.200.36Q2	45
200	45	WOOD	36	4,7-6,0	3,5	10°	CO+FLAT	288.200.36Q	45
200	65	WOOD	36	4,4-5,3	3,2	10°	CO+FLAT	288.200.36J	45
203	15,87	WOOD	12			-12° Neg.	FLAT+ATB	230.312.08	59
203	15,87	WOOD	24			-12° Neg.	FLAT+ATB	230.524.08	58
203	15,87	METAL & STEEL	48	2,2	1,8	0°	8° FWF	226.048.08	55
203	30	WOOD	12			-12° Neg.	FLAT+ATB	230.312.08M	59
210	25	WOOD	36	2,8	1,8	15°	15° ATB	291.210.36L	22
210	25	WOOD	48	2,8	1,8	15°	15° ATB	292.210.48L	26
210	30	MULTI-MATERIALS	12	2,4	1,8	12°	TCG	236.210.12M	10
210	30	WOOD	24	2,8	1,8	20°	10° ATB	290.210.24M	18
210	30	WOOD	36	2,8	1,8	15°	15° ATB	291.210.36M	22
210	30	METAL & STEEL	48	2,2	1,8	0°	8° FWF	226.048.08M	55
210	30	WOOD	48	2,8	1,8	15°	15° ATB	292.210.48M	26
210	30	NON-FERROUS	48	2,8	2,2	-6° Neg.	TCG	296.210.48M	50
210	30	WOOD	64	2,8	1,8	15°	15° ATB	292.210.64M	30
210	30	NON-FERROUS	64	2,8	2,2	-6° Neg.	TCG	296.210.64M	50
210	30	METAL & STEEL	64	2,2	1,8	0°	8° FWF	226.210.64M	54
210	30 (+25)	WOOD	24	1,8	1,2	20°	10° ATB + 8° Shear	271.210.24M	23
210	30 (+25)	WOOD	36	1,8	1,2	15°	10° ATB + 8° Shear	271.210.36M	23
210	30 (+25)	WOOD	48	1,8	1,2	15°	10° ATB + 8° Shear	272.210.48M	27
210	30 (+25)	NON-FERROUS	64	1,8	1,2	-6° Neg.	TCG	276.210.64M	51
215	50	WOOD	42	4,3-5,5	3,2	8°	CO+FLAT	288.215.42T	45
216	30	MULTI-MATERIALS	14	2,4	1,8	12°	TCG	236.216.14M	10
216	30	WOOD	24	2,4	1,6	-5° Neg.	15° ATB	K21624M-X10	12
216	30	WOOD	24	2,8	1,8	-5° Neg.	15° ATB	290.216.24M	18
216	30	MULTI-MATERIALS	30	2,5	2	10°	HR	235.216.30M	47
216	30	WOOD	36	1,8	1,2	-5° Neg.	10° ATB + 8° Shear	271.216.36M	23

D mm	B mm	MATERIALS/APPLICATION	Z	K mm	P mm	α	β	ORDER NO.	PAGE
216	30	NON-FERROUS	40	2,6	2,2	5°	TCG	284.216.40M	48
216	30	WOOD	48	1,8	1,2	-5° Neg.	10° ATB + 8° Shear	272.216.48M	27
216	30	METAL & STEEL	48	2,2	1,8	0°	8° FWF	226.047.09M	55
216	30	WOOD	48	2,3	1,6	-5° Neg.	15° ATB	285.816.48M	24
216	30	WOOD	48	2,4	1,6	-5° Neg.	15° ATB	K21648M-X10	12
216	30	WOOD	48	2,8	1,8	-5° Neg.	15° ATB	291.216.48M	22
216	30	WOOD	60	2,3	1,6	-5° Neg.	15° ATB	285.816.60M	28
216	30	WOOD	64	1,8	1,2	-5° Neg.	10° ATB + 8° Shear	273.216.64M	31
216	30	NON-FERROUS	64	2,2	1,6	-6° Neg.	TCG	276.216.64M	51
216	30	NON-FERROUS	64	2,3	1,6	0°	TCG	297.816.64M	49
216	30	WOOD	64	2,8	1,8	-5° Neg.	15° ATB	292.216.64M	26
216	30	NON-FERROUS	64	2,8	2,2	-6° Neg.	TCG	297.064.09M	50
216	30	WOOD	80	2,8	1,8	-5° Neg.	15° ATB	292.216.80M	30
216	30	NON-FERROUS	80	2,8	2,2	-6° Neg.	TCG	297.080.09M	50
216	30	METAL & STEEL	56	1,8	1,4	0°	TCG	226.556.09M	56
216	30	METAL & STEEL	64	2,2	1,8	0°	8° FWF	226.216.64M	54
220	30	WOOD	24	2,8	1,8	20°	10° ATB	290.220.24M	18
220	30	WOOD	36	2,8	1,8	15°	15° ATB	291.220.36M	22
220	30	WOOD	42	3,2	2,2	-6° Neg.	HDF	287.043.09M	36
220	30	WOOD	42	3,2	2,2	10°	HDF	287.042.09M	37
220	30	WOOD	48	2,8	1,8	15°	15° ATB	292.220.48M	26
220	30	WOOD	63	3,2	2,2	-3° Neg.	FFT	281.063.09M	38
220	30	WOOD	64	3,2	2,2	-5° Neg.	40° Hi-ATB	283.064.09M	33
220	30	WOOD	64	3,2	2,2	10°	TCG	281.064.09M	42
225	30	WOOD	36	2,8	1,8	20°	15° ATB	291.225.36M	22
225	30	WOOD	48	2,8	1,8	10°	15° ATB	292.225.48M	26
225	30	WOOD	64	2,6	1,8	4°	TCG	281.225.64M	42
225	30	NON-FERROUS	64	2,8	2,2	-6° Neg.	TCG	296.225.64M	50
225	32	METAL & STEEL	0	1,9			Not Sharpened	227.225P	53
225	32	METAL & STEEL	180	1,9			BW	227.225.180P	53
230	30	MULTI-MATERIALS	4	2,4	1,8	12°	TCG	236.230.04M	10
230	30	WOOD	24	2,8	1,8	20°	10° ATB	290.230.24M	18
230	30	WOOD	36	2,8	1,8	15°	15° ATB	291.230.36M	22
230	30	WOOD	48	2,8	1,8	15°	15° ATB	292.230.48M	26
230	30	NON-FERROUS	48	2,8	2,2	-6° Neg.	TCG	296.230.48M	50
230	30	WOOD	64	2,8	1,8	15°	15° ATB	292.230.64M	30
235	25	WOOD	24	2,8	1,8	20°	10° ATB	290.235.24L	18
235	25	WOOD	36	1,7	1,2	20°	1 FLAT+2/15° ATB	271.235.36L	23
235	25	WOOD	36	2,8	1,8	15°	15° ATB	291.235.36L	22
235	25	WOOD	48	2,8	1,8	15°	15° ATB	292.235.48L	26
235	30	WOOD	36	2,8	1,8	15°	15° ATB	291.235.36M	22
235	30	METAL & STEEL	48	2,2	1,8	0°	8° FWF	226.048.09M	55
235	30	WOOD	48	2,8	1,8	15°	15° ATB	292.235.48M	26
235	30	NON-FERROUS	48	2,8	2,2	-6° Neg.	TCG	296.235.48M	50
235	30 (+25)	WOOD	24	2,8	1,8	20°	10° ATB	290.235.24M	18
235	30 (+25)	WOOD	36	2,4	1,6	18°	10° ATB + 8° Shear	271.235.36M	23
235	30 (+25)	WOOD	48	2,4	1,6	18°	10° ATB + 8° Shear	272.235.48M	27
240	30	WOOD	24	2,8	1,8	20°	10° ATB	290.240.24M	18
240	30	WOOD	36	2,8	1,8	15°	15° ATB	291.240.36M	22
240	30	WOOD	48	2,8	1,8	15°	15° ATB	292.240.48M	26
250	20	WOOD	40	3,2	2,2	15°	10° ATB	285.040.10H	21
250	30	MULTI-MATERIALS	16	2,4	1,8	12°	TCG	236.250.16M	10
250	30	WOOD	16	2,8	1,8	15°	5° ATB	286.016.10M	11
250	30	WOOD	24	2,4	1,6	20°	10° ATB + 8° Shear	271.250.24M	19
250	30	WOOD	24	2,8	1,8	20°	10° ATB	290.250.24M	18
250	30	WOOD	24	3,2	2,2	10°	FLAT	285.624.10M	17
250	30	MULTI-MATERIALS	36	2,5	2	10°	HR	235.250.36M	47
250	30	WOOD	40	2,6	1,8	15°	10° ATB	K25040M-X05	12
250	30	WOOD	40	3,2	2,2	15°	10° ATB	285.640.10M	20
250	30	WOOD	40	3,2	2,2	15°	10° ATB	285.040.10M	21

D mm	B mm	MATERIALS/APPLICATION	Z	K mm	P mm	α	β	ORDER NO.	PAGE
250	30	WOOD	42	2,4	1,6	18°	10° ATB + 8° Shear	271.250.42M	23
250	30	WOOD	48	3,2	2,2	15°	10° ATB	285.048.10M	21
250	30	WOOD	48	3,2	2,2	-6° Neg.	HDF	287.049.10M	36
250	30	WOOD	48	3,2	2,2	10°	HDF	287.048.10M	37
250	30	WOOD	48	3,2	2,2	10°	45° TCG	237.048.10M	46
250	30	WOOD	60	2,4	1,6	15°	10° ATB + 8° Shear	272.250.60M	27
250	30	WOOD	60	3,2	2,2	10°	15° ATB	285.660.10M	24
250	30	WOOD	60	3,2	2,2	10°	15° ATB	285.060.10M	25
250	30	WOOD	60	3,2	2,2	-3° Neg.	FFT	281.061.10M	38
250	30	WOOD	60	3,2	2,2	10°	TCG	281.060.10M	41
250	30	MULTI-MATERIALS	72	3,2	2,5	0°	MTCG	223.072.10M	57
250	30	WOOD	78	3,2	2,2	10°	FFT	295.078.10M	40
250	30	WOOD	80	2,4	1,6	12°	10° ATB + 8° Shear	273.250.80M	31
250	30	NON-FERROUS	80	2,6	1,8	-6° Neg.	TCG	276.250.80M	51
250	30	MULTI-MATERIALS	80	2,8	2,2	-3° Neg.	MATB	222.080.10M	57
250	30	WOOD	80	3	2,5	10°	20° ATB	285.580.10M	35
250	30	WOOD	80	3,2	2,2	5°	15° ATB	285.680.10M	28
250	30	WOOD	80	3,2	2,2	5°	15° ATB	285.080.10M	29
250	30	WOOD	80	3,2	2,2	-2° Neg.	38° Hi-ATB	283.680.10M	32
250	30	WOOD	80	3,2	2,2	-2° Neg.	40° Hi-ATB	283.080.10M	33
250	30	WOOD	80	3,2	2,2	15°	1° FLAT + 4° ATB	274.080.10M	34
250	30	WOOD	80	3,2	2,2	-3° Neg.	TCG	281.681.10M	38
250	30	WOOD	80	3,2	2,2	5°	TCG	281.680.10M	39
250	30	WOOD	80	3,2	2,2	10°	TCG	281.080.10M	41
250	30	WOOD	80	3,2	2,2	10°	TCG	281.080.10M	43
250	30	NON-FERROUS	80	3,2	2,5	-6° Neg.	TCG	297.080.10M	49
250	30	WOOD	20+4	3,2	2,2	18°	10° ATB	279.020.10M	13
250	32	METAL & STEEL	0	2			Not Sharpened	227.250P	53
250	32	NON-FERROUS	80	3,2	2,5	6°	TCG	284.080.10P	48
250	32	NON-FERROUS	80	3,2	2,5	-6° Neg.	TCG	297.080.10P	49
250	32	METAL & STEEL	128	2			C/HZ	227.250.128P	52
250	32	METAL & STEEL	160	2			BW	227.250.160P	53
250	32	METAL & STEEL	200	2			BW	227.250.200P	53
250	32	METAL & STEEL	200	2			BW	227.250.700P	53
250	35	WOOD	60	3,2	2,2	10°	15° ATB	285.060.10R	25
250	35	WOOD	80	3,2	2,2	5°	15° ATB	285.080.10R	29
250	70	WOOD	20+4	2,7	1,8	50	10° ATB	280.020.10V	14
250	70	WOOD	20+4	3,2	2,2	18°	10° ATB	279.020.10V	13
250	80	WOOD	20+4	2,7	1,8	50	10° ATB	280.020.10W	14
250	80	WOOD	20+4	3,2	2,2	18°	10° ATB	279.020.10W	13
250	30	WOOD	60	3,2	2,2	10°	TCG	281.060.10M	43
250	30	METAL & STEEL	72	2,2	1,8	0°	10° FWF	226.572.10M	56
250	25,4 (+20)	MULTI-MATERIALS	20	2	1,4	2°	8° ATB	298.250.20	63
250	25,4 (+20)	MULTI-MATERIALS	40	2	1,4	2°	8° ATB	298.250.40	63
250	35	WOOD	40	3,2	2,2	15°	10° ATB	285.040.10R	21
254	15,87	METAL & STEEL	48	2,2	1,8	0°	8° FWF	226.048.10	55
254	15,87	METAL & STEEL	60	2,2	1,8	0°	8° FWF	226.060.10	54
254	30	WOOD	48	2,4	1,8	-5° Neg.	15° ATB	294.048.10M	21
254	30	METAL & STEEL	60	2,2	1,8	0°	8° FWF	226.060.10M	54
254	30	WOOD	60	2,4	1,8	-5° Neg.	15° ATB	294.060.10M	25
254	30	NON-FERROUS	80	3,2	2,5	-6° Neg.	TCG	297.081.10M	49
254	15,87	METAL & STEEL	72	2,2	1,8	0°	10° FWF	226.572.10	56
260	30	WOOD	28	2,8	1,8	20°	10° ATB	290.260.28M	18
260	30	WOOD	48	2,8	1,8	15°	10° ATB	285.048.11M	22
260	30	WOOD	60	2,5	1,8	-5° Neg.	10° ATB	285.860.11M	24
260	30	WOOD	60	2,5	1,8	-5° Neg.	15° ATB	294.060.11M	26
260	30	WOOD	60	2,8	1,8	10°	15° ATB	285.060.11M	26
260	30	WOOD	64	2,5	1,8	-3° Neg.	TCG	281.065.11M	42
260	30	WOOD	80	2,5	1,8	-5° Neg.	15° ATB	294.080.11M	30
260	30	NON-FERROUS	80	3,2	2,5	-6° Neg.	TCG	297.080.11M	49

D mm	B mm	MATERIALS/APPLICATION	Z	K mm	P mm	α	β	ORDER NO.	PAGE
270	30	WOOD	28	2,8	1,8	20°	10° ATB	290.270.28M	18
270	30	WOOD	42	2,8	1,8	15°	10° ATB	291.270.42M	21
275	20	WOOD	42	3,2	2,2	15°	10° ATB	285.042.11H	22
275	32	METAL & STEEL	0	2,5			Not Sharpened	227.275P	53
275	32	METAL & STEEL	140	2,5			C/HZ	227.275.140P	52
275	32	METAL & STEEL	220	2			BW	227.275.722P	53
275	32	METAL & STEEL	220	2,5			BW	227.275.720P	53
275	32	METAL & STEEL	220	2,5			BW	227.275.220P	53
280	30	WOOD	64	2,8	1,8	10°	15° ATB	295.064.11M	25
280	30	NON-FERROUS	64	3,2	2,5	-6° Neg.	TCG	297.064.11M	49
300	20	WOOD	48	3,2	2,2	15°	10° ATB	285.048.12H	21
300	30	MULTI-MATERIALS	20	2,4	1,8	12°	TCG	236.300.20M	10
300	30	WOOD	20	2,8	1,8	15°	5° ATB	286.020.12M	11
300	30	WOOD	24	2,6	1,8	22°	10° ATB + 8° Shear	271.300.24M	19
300	30	WOOD	24	3,2	2,2	20°	10° ATB	293.024.12M	17
300	30	WOOD	28	3,2	2,2	18°	10° ATB	278.028.12M	16
300	30	WOOD	36	3,2	2,2	15°	10° ATB	285.036.12M	21
300	30	MULTI-MATERIALS	44	2,5	2	10°	HR	235.300.44M	47
300	30	WOOD	48	2,6	1,8	18°	10° ATB + 8° Shear	271.300.48M	23
300	30	WOOD	48	3,2	2,2	15°	10° ATB	286.048.12M	11
300	30	WOOD	48	3,2	2,2	15°	10° ATB	285.648.12M	20
300	30	WOOD	48	3,2	2,2	15°	10° ATB	285.048.12M	21
300	30	WOOD	60	3,2	2,2	15°	10° ATB	285.060.12M	25
300	30	WOOD	60	3,2	2,2	10°	45° TCG	237.060.12M	46
300	30	WOOD	60	4,4	3,2	16°	TCG	282.060.12M	43
300	30	WOOD	72	2,6	1,8	15°	10° ATB + 8° Shear	272.300.72M	27
300	30	WOOD	72	3,2	2,2	10°	15° ATB	285.672.12M	24
300	30	WOOD	72	3,2	2,2	10°	15° ATB	285.072.12M	25
300	30	WOOD	72	3,2	2,2	-3° Neg.	FFT	281.073.12M	38
300	30	WOOD	72	3,2	2,2	10°	TCG	281.672.12M	39
300	30	WOOD	72	3,2	2,2	10°	TCG	281.072.12M	41
300	30	WOOD	72	3,2	2,2	10°	TCG	281.072.12M	43
300	30	MULTI-MATERIALS	84	3,2	2,5	0°	MTCG	223.084.12M	57
300	30	WOOD	96	2,6	1,8	12°	10° ATB + 8° Shear	273.300.96M	31
300	30	NON-FERROUS	96	2,8	2	-6° Neg.	TCG	276.300.96M	51
300	30	MULTI-MATERIALS	96	2,8	2,2	-3° Neg.	MATB	222.096.12M	57
300	30	WOOD	96	3	2,5	10°	20° ATB	285.596.12M	35
300	30	WOOD	96	3,2	2,2	5°	15° ATB	285.696.12M	28
300	30	WOOD	96	3,2	2,2	5°	15° ATB	285.096.12M	29
300	30	WOOD	96	3,2	2,2	2°	38° Hi-ATB	283.696.12M	32
300	30	WOOD	96	3,2	2,2	2°	40° Hi-ATB	283.096.12M	33
300	30	WOOD	96	3,2	2,2	-3° Neg.	TCG	281.697.12M	38
300	30	WOOD	96	3,2	2,2	5°	TCG	281.696.12M	39
300	30	WOOD	96	3,2	2,2	10°	FFT	295.096.12M	40
300	30	WOOD	96	3,2	2,2	10°	TCG	281.096.12M	41
300	30	WOOD	96	3,2	2,2	10°	TCG	281.096.12M	43
300	30	WOOD	96	3,2	2,2	15°	45° TCG	237.096.12M	46
300	30	NON-FERROUS	96	3,2	2,5	-6° Neg.	TCG	297.096.12M	49
300	30	WOOD	100	3,2	2,2	15°	1° FLAT + 4° ATB	274.100.12M	34
300	30	WOOD	24+4	3,2	2,2	18°	10° ATB	279.024.12M	13
300	30	WOOD	24+4	4	2,8	18°	10° ATB	277.024.12M	15
300	32	METAL & STEEL	0	2,5			Not Sharpened	227.300P	53
300	32	NON-FERROUS	96	3,2	2,5	6°	TCG	284.096.12P	48
300	32	NON-FERROUS	96	3,2	2,5	-6° Neg.	TCG	297.096.12P	49
300	32	METAL & STEEL	160	2,5			C/HZ	227.300.160P	52
300	32	METAL & STEEL	220	2			BW	227.300.722P	53
300	32	METAL & STEEL	220	2,5			BW	227.300.220P	53
300	32	METAL & STEEL	220	2,5			BW	227.300.720P	53
300	35	WOOD	24	3,2	2,2	20°	10° ATB	293.024.12R	17
300	35	WOOD	48	3,2	2,2	15°	10° ATB	285.048.12R	21

D mm	B mm	MATERIALS/APPLICATION	Z	K mm	P mm	α	β	ORDER NO.	PAGE
300	35	WOOD	72	3,2	2,2	10°	15° ATB	285.072.12R	25
300	35	WOOD	96	3,2	2,2	5°	15° ATB	285.096.12R	29
300	50	WOOD	48	4,3-5,5	3,2	10°	CO+FLAT	288.300.48T	45
300	60	WOOD	24+4	3,2	2,2	18°	10° ATB	279.024.12U	13
300	65	WOOD	72	4,3-5,5	3,2	10°	CO+FLAT	288.300.72J	45
300	70	WOOD	28	3,2	2,2	18°	10° ATB	278.028.12V	16
300	70	WOOD	24+4	2,7	1,8	60	10° ATB	280.024.12V	14
300	70	WOOD	24+4	3,2	2,2	18°	10° ATB	279.024.12V	13
300	70	WOOD	24+4	4	2,8	18°	10° ATB	277.024.12V	15
300	75	WOOD	60	4,4	3,2	16°	TCG	282.060.12X	43
300	80	WOOD	60	4,4	3,2	16°	TCG	282.060.12W	43
300	80	WOOD	24+4	2,7	1,8	60	10° ATB	280.024.12W	14
300	80	WOOD	24+4	3,2	2,2	18°	10° ATB	279.024.12W	13
300	80	WOOD	24+4	4	2,8	18°	10° ATB	277.024.12W	15
300	30	METAL & STEEL	80	2,2	1,8	0°	10° FWF	226.580.12M	56
303	30	WOOD	60	3,2	2,2	-6° Neg.	HDF	287.061.12M	36
303	30	WOOD	60	3,2	2,2	10°	HDF	287.060.12M	37
305	25,4	METAL & STEEL	60	2,2	1,8	0°	8° FWF	226.060.12	55
305	25,4	METAL & STEEL	80	2,2	1,8	0°	8° FWF	226.080.12	54
305	30	WOOD	28	2,8	1,8	20°	10° ATB	293.028.22M	17
305	30	WOOD	48	2,6	1,8	-5° Neg.	10° ATB	271.305.48M	23
305	30	WOOD	54	2,8	1,8	-5° Neg.	15° ATB	294.054.22M	21
305	30	WOOD	72	2,6	1,8	-5° Neg.	10° ATB	272.305.72M	27
305	30	WOOD	72	3,2	2,2	10°	15° ATB	285.072.22M	25
305	30	WOOD	72	3,2	2,2	-5° Neg.	15° ATB	294.072.22M	25
305	30	METAL & STEEL	80	2,2	1,8	0°	8° FWF	226.080.12M	54
305	30	NON-FERROUS	96	2,8	2	-6° Neg.	TCG	276.305.96M	51
305	30	NON-FERROUS	96	3,2	2,5	-6° Neg.	TCG	297.096.13M	49
305	25,4	METAL & STEEL	80	2,2	1,8	0°	10° FWF	226.580.12	56
315	30	WOOD	24	3,2	2,2	15°	5° ATB	286.024.13M	11
315	30	WOOD	28	3,2	2,2	20°	10° ATB	293.028.12M	17
315	30	WOOD	36	3,2	2,2	15°	5° ATB	285.036.13M	17
315	30	WOOD	54	3,2	2,2	15°	10° ATB	294.054.12M	21
315	30	WOOD	72	3,2	2,2	15°	10° ATB	285.072.13M	25
315	30	NON-FERROUS	96	3,2	2,5	-6° Neg.	TCG	297.096.23M	49
315	32	METAL & STEEL	0	2,5			Not Sharpened	227.315P	53
315	32	METAL & STEEL	160	2,5			C/HZ	227.315.160P	52
315	32	METAL & STEEL	240	2,5			BW	227.315.240P	53
315	32	METAL & STEEL	240	2,5			BW	227.315.740P	53
320	65	WOOD	60	4,4	3,2	16°	TCG	Y282.060.13J	43
320	65	WOOD	72	4,4	3,2	16°	TCG	282.072.13J	43
330	30	NON-FERROUS	96	3,6	3	-6° Neg.	TCG	297.096.33M	49
330	32	NON-FERROUS	96	3,6	3	-6° Neg.	TCG	297.096.33P	49
350	30	WOOD	24	3,2	2,2	15°	5° ATB	286.024.14M	11
350	30	WOOD	28	3,5	2,5	20°	10° ATB	293.028.14M	17
350	30	WOOD	36	3,5	2,5	18°	10° ATB	278.036.14M	16
350	30	WOOD	54	3,5	2,5	15°	10° ATB	285.654.14M	20
350	30	WOOD	54	3,5	2,5	15°	10° ATB	285.054.14M	21
350	30	WOOD	54	4,4	3,2	16°	TCG	282.054.14M	43
350	30	WOOD	72	3,5	2,4	15°	45° TCG	237.072.14M	46
350	30	WOOD	72	3,5	2,5	15°	10° ATB	285.072.14M	25
350	30	WOOD	72	4,4	3,2	16°	TCG	282.072.14M	43
350	30	WOOD	84	3,5	2,5	10°	15° ATB	285.684.14M	24
350	30	WOOD	84	3,5	2,5	10°	15° ATB	285.084.14M	25
350	30	WOOD	84	3,5	2,5	10°	TCG	281.684.14M	39
350	30	WOOD	84	3,5	2,5	10°	TCG	281.084.14M	41
350	30	WOOD	108	3,5	2,5	5°	15° ATB	285.708.14M	28
350	30	WOOD	108	3,5	2,5	5°	15° ATB	285.108.14M	29
350	30	WOOD	108	3,5	2,5	5°	40° Hi-ATB	283.108.14M	33
350	30	WOOD	108	3,5	2,5	5°	TCG	281.708.14M	39

D mm	B mm	MATERIALS/APPLICATION	Z	K mm	P mm	α	β	ORDER NO.	PAGE
350	30	WOOD	108	3,5	2,5	10°	FFT	295.108.14M	40
350	30	WOOD	108	3,5	2,5	10°	TCG	281.108.14M	41
350	30	WOOD	108	3,5	2,5	10°	TCG	281.108.14M	43
350	30	NON-FERROUS	108	3,6	3	-6° Neg.	TCG	297.108.14M	49
350	30	WOOD	24+6	4,2	2,8	18°	10° ATB	277.024.14M	15
350	30	WOOD	28+4	3,5	2,5	18°	10° ATB	279.028.14M	13
350	32	METAL & STEEL	0	2,5			Not Sharpened	227.350P	53
350	32	NON-FERROUS	84	3,6	3	6°	TCG	284.092.14P	48
350	32	NON-FERROUS	108	3,6	3	6°	TCG	284.108.14P	48
350	32	NON-FERROUS	108	3,6	3	-6° Neg.	TCG	297.108.14P	49
350	32	METAL & STEEL	180	2,5			C/HZ	227.350.180P	52
350	32	METAL & STEEL	280	2,5			BW	227.350.280P	53
350	32	METAL & STEEL	280	2,5			BW	227.350.780P	53
350	35	WOOD	28	3,5	2,5	20°	10° ATB	293.028.14R	17
350	35	WOOD	54	3,5	2,5	15°	10° ATB	285.054.14R	21
350	35	WOOD	84	3,5	2,5	10°	15° ATB	285.084.14R	25
350	35	WOOD	108	3,5	2,5	5°	15° ATB	285.108.14R	29
350	50	WOOD	72	4,4	3,2	16°	TCG	282.072.14T	43
350	60	WOOD	72	4,4	3,2	16°	TCG	Y282.072.14U	43
350	60	WOOD	28+4	3,5	2,5	18°	10° ATB	279.028.14U	13
350	70	WOOD	36	3,5	2,5	18°	10° ATB	278.036.14V	16
350	70	WOOD	24+6	4,2	2,8	18°	10° ATB	277.024.14V	15
350	70	WOOD	28+4	3,5	2,5	18°	10° ATB	279.028.14V	13
350	75	WOOD	54	4,4	3,2	16°	TCG	282.054.14X	43
350	75	WOOD	72	4,4	3,2	16°	TCG	282.072.14X	43
350	80	WOOD	54	4,4	3,2	16°	TCG	282.054.14W	43
350	80	WOOD	72	4,4	3,2	16°	TCG	282.072.14W	43
350	80	WOOD	28+4	3,5	2,5	18°	10° ATB	279.028.14W	13
355	25,4	METAL & STEEL	72	2,2	1,8	0°	8° FWF	226.072.14	55
355	25,4	METAL & STEEL	90	2,2	1,8	0°	8° FWF	226.090.14	54
355	25,4	METAL & STEEL	90	2,2	1,8	0°	10° FWF	226.590.14	56
355	30	WOOD	72	4,4	3,2	16°	TCG	S282.03556	43
355	30	METAL & STEEL	90	2,2	1,8	0°	8° FWF	226.090.14M	54
355	30	METAL & STEEL	90	2,2	1,8	0°	10° FWF	226.590.14M	56
355	65	WOOD	72	4,4	3,2	16°	TCG	282.072.14J2	43
355	80	WOOD	72	4,4	3,2	10°	TCG	282.072.14W2	43
380	60	WOOD	72	4,4	3,2	15°	TCG	282.072.15U2	43
380	60	WOOD	72	4,8	3,5	16°	TCG	282.072.15U	43
380	80	WOOD	72	4,4	3,2	16°	TCG	282.072.15W	43
400	30	WOOD	28	3,2	2,2	15°	5° ATB	286.028.16M	11
400	30	WOOD	36	3,5	2,5	20°	10° ATB	285.036.16M	17
400	30	WOOD	48	3,5	2,5	20°	10° ATB	285.048.16M	21
400	30	WOOD	60	3,5	2,5	10°	15° ATB	285.660.16M	20
400	30	WOOD	60	3,5	2,5	10°	15° ATB	285.060.16M	25
400	30	WOOD	60	4,4	3,2	16°	TCG	282.060.16M	43
400	30	WOOD	72	4,4	3,2	16°	TCG	282.072.16M	43
400	30	WOOD	96	3,5	2,5	10°	15° ATB	285.696.16M	24
400	30	WOOD	96	3,5	2,5	10°	15° ATB	285.096.16M	29
400	30	WOOD	120	3,5	2,5	10°	15° ATB	285.120.16M	29
400	30	NON-FERROUS	120	4	3,2	-6° Neg.	TCG	297.120.16M	49
400	30	WOOD	28+6	4	2,8	18°	10° ATB	279.028.16M	13
400	32	NON-FERROUS	96	4	3,2	6°	TCG	284.096.16P	48
400	32	NON-FERROUS	96	4	3,2	-6° Neg.	TCG	297.108.16P	49
400	32	NON-FERROUS	120	4	3,2	-6° Neg.	TCG	297.120.16P	49
400	60	WOOD	72	4,4	3,2	16°	TCG	282.072.16U	43
400	70	WOOD	28+6	4	2,8	18°	10° ATB	279.028.16V	13
400	75	WOOD	60	4,4	3,2	16°	TCG	282.060.16X	43
400	75	WOOD	72	4,4	3,2	16°	TCG	282.072.16X	43
400	80	WOOD	60	4,4	3,2	16°	TCG	282.060.16W	43
400	80	WOOD	72	4,4	3,2	16°	TCG	282.072.16W	43

D mm	B mm	MATERIALS/APPLICATION	Z	K mm	P mm	α	β	ORDER NO.	PAGE
420	32	NON-FERROUS	96	3,8	3,2	6°	TCG	284.096.17P	48
420	80	WOOD	72	4,4	3,2	15°	TCG	282.072.17W	43
430	65	WOOD	72	4,4	3,2	16°	TCG	Y282.072.17J	43
430	75	WOOD	72	4,4	3,2	16°	TCG	282.072.17X	43
430	80	WOOD	72	4,4	3,2	16°	TCG	282.072.17W2	43
450	30	WOOD	32	3,8	2,8	15°	5° ATB	286.032.18M	11
450	30	WOOD	36	3,8	2,8	20°	10° ATB	285.036.18M	17
450	30	WOOD	54	3,8	2,8	15°	15° ATB	285.054.18M	21
450	30	WOOD	66	3,8	2,8	10°	15° ATB	285.066.18M	25
450	30	WOOD	72	4,4	3,2	16°	TCG	Y282.072.18M2	43
450	30	NON-FERROUS	96	4,2	3,5	-6° Neg.	TCG	297.108.18M	49
450	30	NON-FERROUS	108	4,2	3,5	6°	TCG	284.108.18M	48
450	30	NON-FERROUS	120	4,2	3,5	-6° Neg.	TCG	Y297.140.18M	49
450	32	NON-FERROUS	96	4,2	3,5	-6° Neg.	TCG	297.108.18P	49
450	32	NON-FERROUS	108	4,2	3,5	6°	TCG	284.108.18P	48
450	32	NON-FERROUS	120	4,2	3,5	-6° Neg.	TCG	297.120.18P	49
450	60	WOOD	72	4,8	3,5	16°	TCG	282.072.18U	43
450	80	WOOD	72	4,8	3,5	16°	TCG	282.072.18W2	43
500	30	WOOD	36	3,8	2,8	15°	5° ATB	286.036.20M	11
500	30	WOOD	44	4	2,8	20°	10° ATB	285.044.20M	17
500	30	WOOD	60	3,8	2,8	15°	15° ATB	285.060.20M	21
500	30	WOOD	72	3,8	2,8	10°	15° ATB	285.072.20M	25
500	30	NON-FERROUS	120	4,3	3,5	10°	TCG	284.120.20M	48
500	30	NON-FERROUS	120	4,3	3,5	-6° Neg.	TCG	297.120.20M	49
500	32	NON-FERROUS	120	4,3	3,5	10°	TCG	284.120.20P	48
500	32	NON-FERROUS	120	4,3	3,5	-6° Neg.	TCG	297.120.20P	49
500	60	WOOD	72	4,8	3,5	16°	TCG	282.072.20U	43
500	80	WOOD	72	4,8	3,5	16°	TCG	Y282.072.20W	43
550	30	WOOD	40	4,2	3,2	15°	5° ATB	286.040.22M	11
550	30	WOOD	60	4,2	3,2	10°	15° ATB	285.060.22M	21
550	30	WOOD	96	4,2	3,2	10°	15° ATB	285.096.22M	25
550	100	WOOD	72	5,2	3,5	16°	TCG	282.072.22A	43
600	30	WOOD	40	4,2	3,2	15°	5° ATB	286.040.24M	11
600	30	WOOD	66	4,2	3,2	10°	15° ATB	285.066.24M	21
700	30	WOOD	46	4,4	3,2	15°	5° ATB	286.046.28M	11
700	30	WOOD	72	4,4	3,2	10°	15° ATB	285.072.28M	21

QUALITY MATERIALS FOR OUTSTANDING PERFORMANCE

Designed and crafted using state-of-the-art processes as well as high-tech machinery these jig saw blades carry out precise cuts on a variety of materials: soft & hardwood, plywood, OSB, laminates, plastics, HPL, multiplex panels, metals, ferrous & non-ferrous materials, aluminium, fiberglass as well as stainless steel. CMT jig saw blades come in four different materials made to outperform the competition and deliver impressive results.

GEOMETRY IS IMPORTANT!

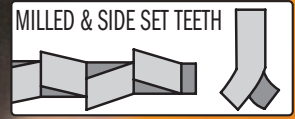

MILLED & SIDE SET TEETH

Jig saw blades featuring this kind of geometry produce a quick rough cut into soft/hardwood, aluminium, plastic and non-ferrous metals.



MILLED & WAVY SET TEETH

Suitable for fine straight cuts into plywood, soft steel, aluminium, non-ferrous metals and plastic.



GROUND & SIDE SET TEETH

Best for quick cuts in wood.



GROUND & TAPER GROUND TEETH

This geometric attribute creates fine, clean and precise cuts in wood and plastic.



High Carbon Steel
Great for cutting wood, fiberboard and plastic.



Bi-Metal with 8% Cobalt
Premium bi-metal with 8% Cobalt provides superb results and guarantees long life when cutting metal, non-ferrous, plastic and wood with nails.



High Speed Steel
For cutting harder materials, such as metals, aluminium and non-ferrous metals.



Tungsten Carbide Tipped
For cutting fibercement board, brick, porous concrete, plasterboard, MDF, fiberglass and ETERNIT®.

THE RIGHT BLADE FOR THE BEST RESULTS!

A quick reference chart and pictograms will help you select the right blade for your application.





/// Wood

/// Wood & Metal

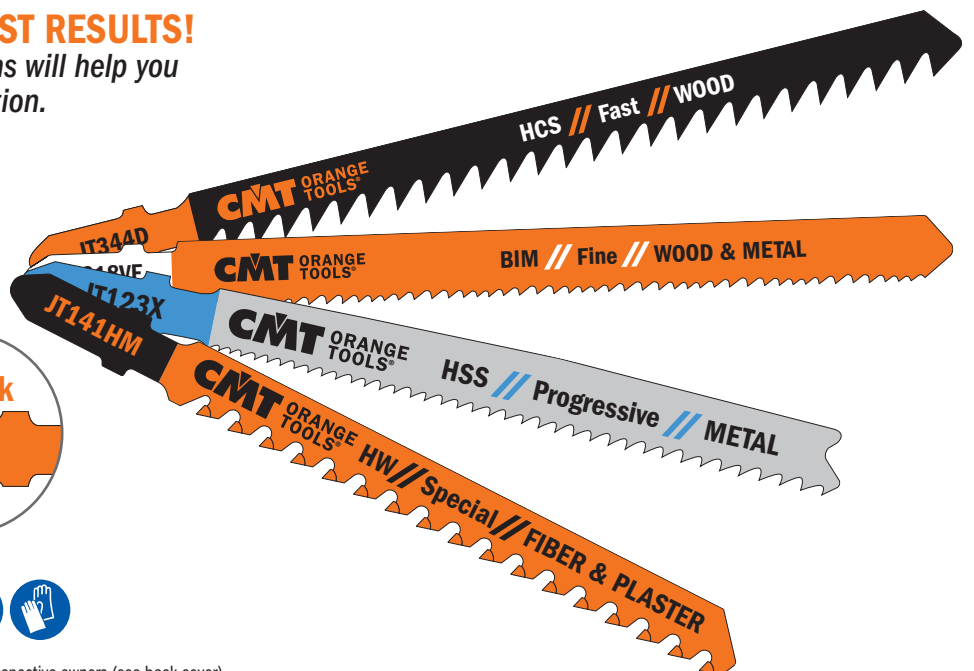
/// Metal

/// Special



Series	Material	Thickness  mm	Line	Fine Straight 	Coarse Straight 	Fine Curve 	Coarse Curve 	Page	
WOOD	Softwood	1,5~15	Fine			JT101AO		78	
		2~15	Basic			JT119BO		77	
		3~65	Fine, Splinter-Free	JT234X					79
		3~30	Fine	JT101B					78
		3~30	Fine, Splinter-Free	JT101BR					78
		4~60	Basic			JT111C			77
		5~60	Fast			JT144D		JT244D - JT244DDC	77
		5~100	Fast			JT344D			78
		7~55	Fine	JT101D					79
	7~65	Fine	JT301CD - JT318VF					79	
	Hardwood	1,5~15	Fine				JT101AO		78
		3~30	Fine	JT101B					78
		3~30	Fine, Splinter-Free	JT101BR					78
		3~65	Fine, Splinter-Free	JT234X					79
		5~60	Fast			JT144D		JT244D - JT244DDC	77
		5~100	Fast			JT344D			78
		7~55	Fine	JT101D					79
		7~65	Fine	JT301CD - JT318VF					79
		OSB	2~15	Basic				JT119BO	
	3~30		Fine	JT101B					78
	4~60		Basic			JT111C			77
	5~60		Fast			JT144D		JT244D - JT244DDC	77
	7~55		Fine	JT101D - JT318VF					79
	Plywood		1,5~15	Fine				JT101AO	
		2~15	Basic				JT119BO		77
		3~30	Fine	JT101B					78
		3~30	Fine, Splinter-Free	JT101BR					78
		3~65	Fine, Splinter-Free	JT234X - JT318VF					79
		4~60	Basic			JT111C			77
		5~60	Fast			JT144D		JT244D - JT244DDC	77
		5~100	Fast			JT344D			78
		7~55	Fine	JT101D - JT318VF					79
		Construction Wood	<30	Fine	JT101B				
	3~65		Fine, Splinter-Free	JT234X					79
	<100		Fast			JT344D			78
	<135		Fast			JT144D			77
	Chipboard	2~15	Basic				JT119BO		77
		3~30	Fine	JT101B			JT101AO		78
		3~65	Fine, Splinter-Free	JT234X - JT318VF					79
		4~60	Basic			JT111C			77
		5~60	Fast			JT144D		JT244D - JT244DDC	77
		Laminated panels Kitchen Tops Worktops	1,5~15	Fine				JT101AO	
	1,5~15		Fine, Long Life	JT101BIF					79
	3~30		Fine	JT101B					78
	3~30		Fine, Splinter-Free	JT101BR					78
3~65	Fine, Splinter-Free		JT234X					79	
METAL	Sheet metals	1~3	Basic	JT118A		JT218A		80	
		1,5~10	Fast, Long Life	JT123X - JT318VF				79-80	
		2,5~6	Basic	JT118B				80	
	Aluminium, non-ferrous	<30	Fast	JT127D					80
		1,5~10	Fast	JT123X - JT318VF				79-80	
	Pipes	<30	Fast	JT123X - JT318VF				79-80	
	Inox Sheets	1,5~3	Fast	JT123X - JT318VF				79-80	
	Sandwich Material	<120	Fast, Flexible	JT718BF				80	
	PLASTIC	GRP (Fiberglass)	<30	Fast	JT127D				80
		Plastic (PP, PE, PVC, PA, PS)	<30	Fine	JT101D				79
<30			Fast	JT123X				80	
7~65			Fine	JT301CD - JT318VF				79	
SPECIAL	Plasterboard	5~50	Special			JT141HM		81	
		5~80	Special			JT341HM		81	
	GRP (Fiberglass)	<80	Special			JT341HM		81	
	Fiber cement boards	5~50	Special			JT141HM		81	
		5~80	Special			JT341HM		81	
	Carton, Leather, Rubber	<100	Special	JT313AW				81	
Soft Tile, Cast Iron	5~10	Special	JT150RF				81		

Jig Saw Blades

JT119BO



PACK Quantity	L mm	I mm	TS mm	TPI		ORDER NO. T Shank
5	76	50	2	12	100	JT119BO-5

Curve cuts on softwood (2~15mm), plywood, OSB.

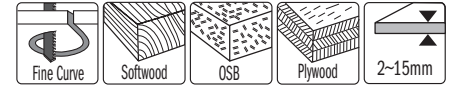
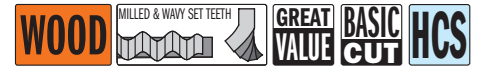

JT111C



PACK Quantity	L mm	I mm	TS mm	TPI		ORDER NO. T Shank
5	100	75	3	8	100	JT111C-5

Fast coarse cuts on softwood (4~60mm), plywood, OSB.



JT144D



PACK Quantity	L mm	I mm	TS mm	TPI		ORDER NO. T Shank
5	100	75	4	6	100	JT144D-5
25	100	75	4	6	10	JT144D-25
100	100	75	4	6	4	JT144D-100

Very fast cuts, straight and coarse, on hard/softwood (5~60mm), plywood, OSB. Plunge cutting.

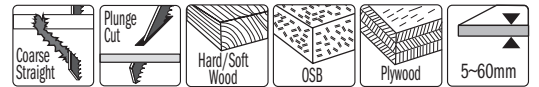

JT244D



PACK Quantity	L mm	I mm	TS mm	TPI		ORDER NO. T Shank
5	100	75	4	6	100	JT244D-5

Fast, curve, coarse cut on soft and hardwood (5~60mm), plywood, OSB. Plunge cutting.

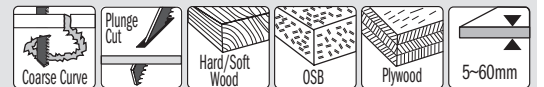

JT244DDC



PACK Quantity	L mm	I mm	TS mm	TPI		ORDER NO. T Shank
5	100	75	4	6	100	JT244DDC-5

Fast, curve, coarse cut on soft and hardwood (5~60mm), plywood, OSB. Plunge cutting. Special "DUO" (double) cuts for fast curve cutting.

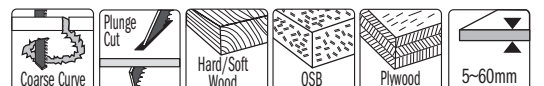

Jig Saw Blades

JT344D



PACK Quantity	L mm	I mm	TS mm	TPI		ORDER NO. T Shank
5	132	110	4	6	100	JT344D-5



Very fast cuts, straight and coarse on thick construction timber, hard/softwood (5~100mm), plywood, OSB.

JT744D



PACK Quantity	L mm	I mm	TS mm	TPI		ORDER NO. T Shank
3	180	155	4	6	20	JT744D-3



Very fast cuts, straight and coarse on thick construction timber, hard/softwood (5~135mm) and sandwich material.

JT101AO

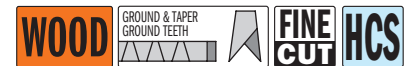

PACK Quantity	L mm	I mm	TS mm	TPI		ORDER NO. T Shank
5	76	50	1,4	20	100	JT101AO-5

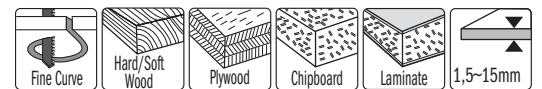

Curved cuts, fine finishing on both sides of surface on hard/softwood, plywood, chipboard, MDF, double sided laminates (1,5~15mm).

JT101B



PACK Quantity	L mm	I mm	TS mm	TPI		ORDER NO. T Shank
5	100	75	2,5	10	100	JT101B-5
25	100	75	2,5	10	10	JT101B-25

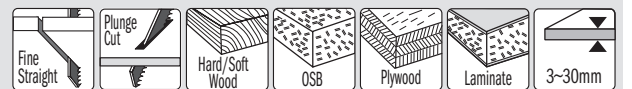

Fine straight cuts with fine finishing on hard/softwood, plywood, OSB and plastics (3~30mm). Plunge cutting.

JT101BR

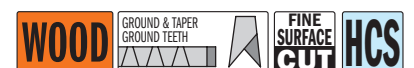

PACK Quantity	L mm	I mm	TS mm	TPI		ORDER NO. T Shank
5	100	75	2,5	10	100	JT101BR-5
25	100	75	2,5	10	10	JT101BR-25

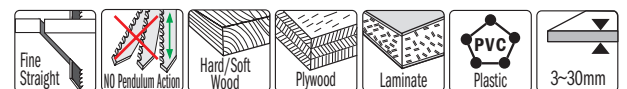

Straight cuts, fine finishing on upper side, hard/softwood, plywood, OSB, laminated panels, plastics (3~30mm). Reverse tooth.

Jig Saw Blades



JT101D

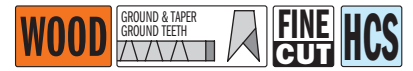

PACK Quantity	L mm	I mm	TS mm	TPI		ORDER NO. T Shank
5	100	75	4	6	100	JT101D-5

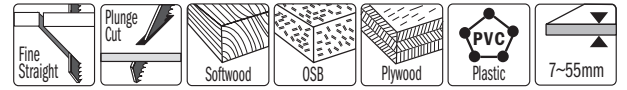

Straight cuts, fine finishing on upper side, on hard/softwood, plywood, OSB, laminates and plastics (7~55mm). Plunge cutting.

JT301CD

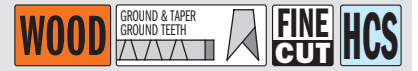
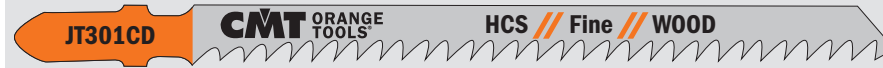

PACK Quantity	L mm	I mm	TS mm	TPI		ORDER NO. T Shank
5	116	90	3	8	100	JT301CD-5

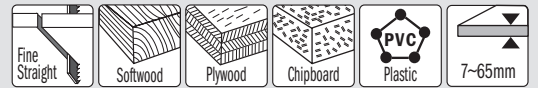

Straight cuts, good finishing, on hard/softwood, plywood, laminates and plastics (7~65mm).

JT234X

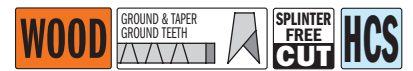

PACK Quantity	L mm	I mm	TS mm	TPI		ORDER NO. T Shank
5	116	90	2-3	8-12	100	JT234X-5

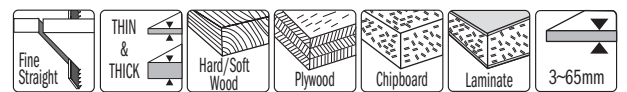

Extra-clean straight cuts, splinter-free finish, on hard/softwood, plywood, OSB, laminates (3~65mm).

JT101BIF



PACK Quantity	L mm	I mm	TS mm	TPI		ORDER NO. T Shank
5	83	58	1,7	15	100	JT101BIF-5

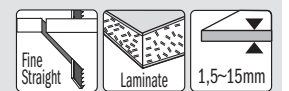

Splinter-free cuts. Special for all laminates, HPL and multiplex panels (1,5~15mm).

JT318VF



PACK Quantity	L mm	I mm	TS mm	TPI		ORDER NO. T Shank
5	132	100	1,7-2,6	10-15	100	JT318VF-5

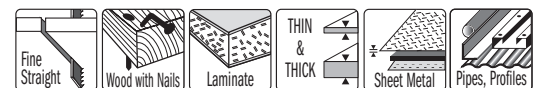

Straight cuts on wood with nails/metal, chipboard and laminate (<60mm), sheet metal, aluminium profiles (3~18mm), glass fiber reinforced plastic/epoxy (<60mm).

Jig Saw Blades



JT118A



PACK Quantity	L mm	I mm	TS mm	TPI		ORDER NO. T Shank
5	76	50	1,2	21	100	JT118A-5

Straight cuts on thin sheet metals, ferrous and non-ferrous (1~3mm).



JT218A



PACK Quantity	L mm	I mm	TS mm	TPI		ORDER NO. T Shank
5	76	50	1,2	21	100	JT218A-5

Curve cuts on thin sheet metals, ferrous and non-ferrous (1~3mm).



JT118B



PACK Quantity	L mm	I mm	TS mm	TPI		ORDER NO. T Shank
5	76	50	2	12	100	JT118B-5

Straight cuts on medium-thick metals, ferrous and non-ferrous (2,5~6mm).



JT123X



PACK Quantity	L mm	I mm	TS mm	TPI		ORDER NO. T Shank
5	100	75	1,2-2,6	10-21	100	JT123X-5

Straight cuts on thin to thick sheet metals (1,5~10mm), pipes, profiles in plastic and aluminium (<30mm), stainless steel (1,5~3mm).

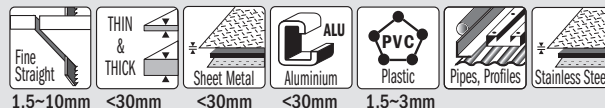

JT127D



PACK Quantity	L mm	I mm	TS mm	TPI		ORDER NO. T Shank
5	100	75	3	8	100	JT127D-5

Special for aluminium, thin to thick (3~15mm), pipes and profiles, (<30mm) including plastic, fiberglass and epoxy.

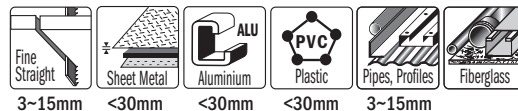
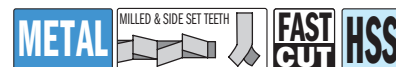

JT718BF



PACK Quantity	L mm	I mm	TS mm	TPI		ORDER NO. T Shank
3	185	160	1,8	14	20	JT718BF-3

Special for Sandwich Materials & Solid Surfaces (<120mm).

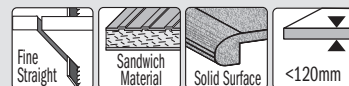

Jig Saw Blades



JT141HM

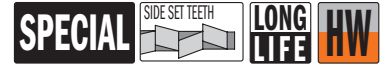

Pack Quantity	L mm	I mm	TS mm	TPI		ORDER NO. T Shank
3	100	75	4,3	6	50	JT141HM-3

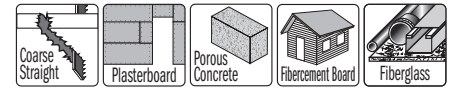

Plasterboard, fiber cement boards (<50mm). Fiberglass/Epoxy (5~20mm), ETERNIT®, MDF, HDF.

JT341HM



Pack Quantity	L mm	I mm	TS mm	TPI		ORDER NO. T Shank
3	132	110	4,3	6	50	JT341HM-3

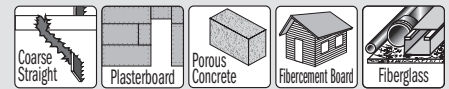

Plasterboard, fiber cement boards (<80mm). Fiberglass/Epoxy (5~50mm), ETERNIT®, MDF, HDF.

JT313AW



new



Pack Quantity	L mm	I mm	TS mm	TPI		ORDER NO. T Shank
3	152	100	1,2	1	100	JT313AW-3

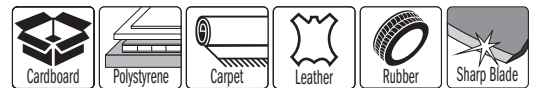

Cardboard, polystyrene, carpet, leather, rubber, fiberglass thermal insulation panels (<100mm).

JT150RF



new



Pack Quantity	L mm	I mm	TS mm	TPI		ORDER NO. T Shank
3	83	75			50	JT150RF-3

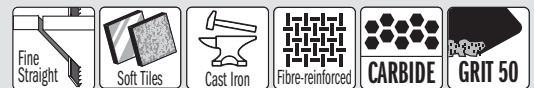

Soft ceramic tiles, cast iron (5-10mm), reinforced fiberglass.

JT016 16-Piece Jig Saw Blade Set

	JT144D HCS	WOOD	FAST CUT		JT141HM HW	SPECIAL	LONG LIFE
	JT101B HCS	WOOD	FINE CUT		JT123X HSS	METAL	FAST CUT
	JT101BR HCS	WOOD	FINE SURFACE CUT		JT118A HSS	METAL	BASIC CUT
	JT101BIF BIM	WOOD	FINE CUT		JT118B HSS	METAL	BASIC CUT
	JT101A0 HCS	WOOD	FINE CUT		JT218A HSS	METAL	BASIC CUT



15 Sets in End-cap display (minimum order 15 sets)



- An assortment of 16 Jig Saw Blades featuring the 10 most popular blades for a variety of cutting needs:
- wood and timber (straight, curve cuts, course cutting and finishing);
 - plasterboard, fiber cement, fiberglass, epoxy resins, and panels such as ETERNIT®;
 - metal and sheet metal both thick and thin;
 - stainless steel;
 - aluminium and plastics.



GEOMETRY IS IMPORTANT!

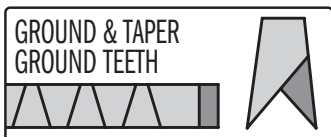

Easily cut construction wood, plywood, framing lumber and plastic.

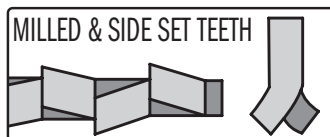

For quick cutting on hard/softwood, aluminium, plastic, ferrous and non-ferrous metal.

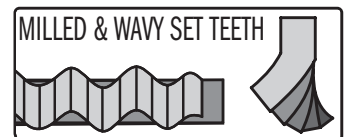

For fine, precise cuts in thin/thick metal, pipe, open and closed profiles.

HCS **High Carbon Steel**
For cuts on soft wood or plastic.

BIM **Bi-Metal with 8% Cobalt**
Provides superb results and guarantees long life when cutting metals, plastic and wood with nails.

HW **Tungsten Carbide Tipped**
Ideal for construction materials: fibercement board, brick and porous concrete.



QUALITY MATERIALS FOR MAXIMUM PRODUCTIVITY

Produced by following state-of-the-art processes, using high-tech machines and premium quality raw materials, these sabre saw blades have been specifically designed to ensure maximum lifetime and performance in all materials.

THE RIGHT BLADE FOR THE JOB!

Use our quick reference chart and pictograms to help you choose the best blade for your application.



Non-Stick Orange Shield Coating

Keeps the blade running cool, reduces pitch build up and protects against corrosion. Ideal for all types of wood including wet lumber.

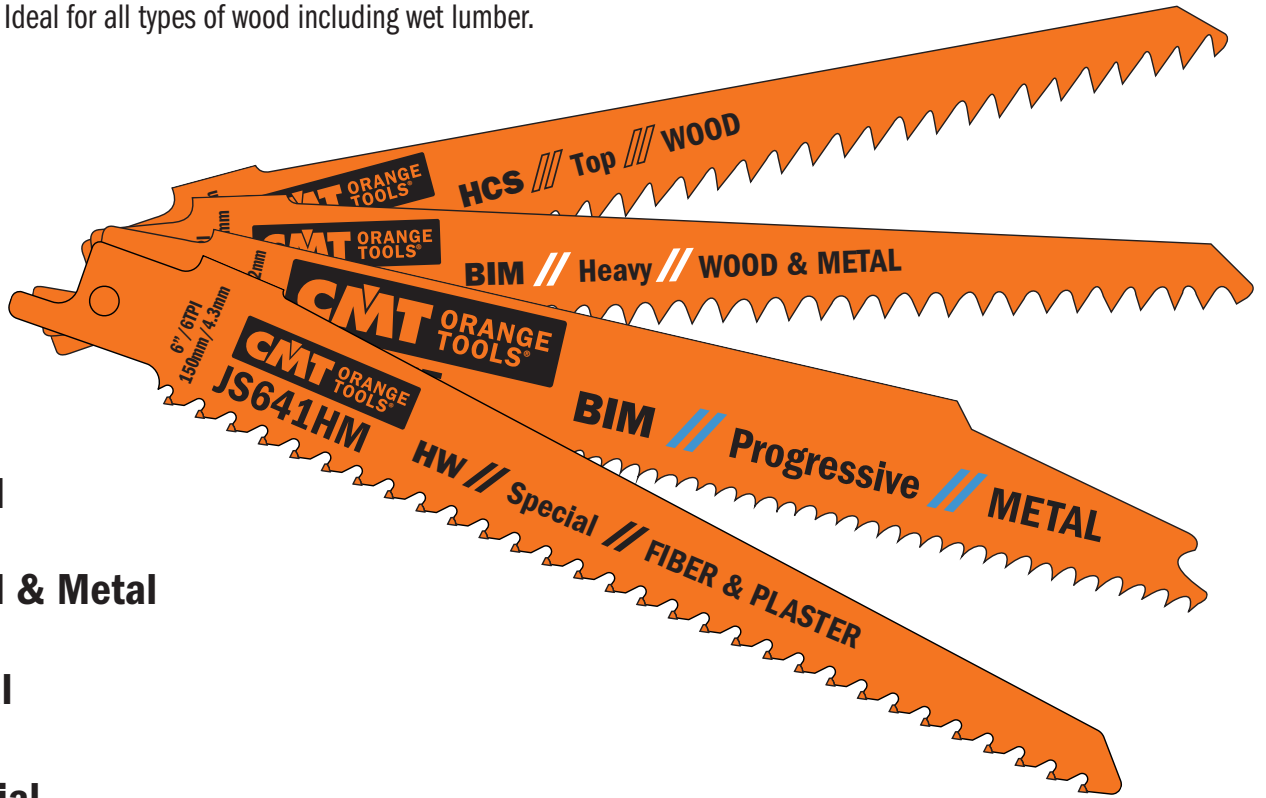

Wood

Wood & Metal

Metal

Special

BLADE LINE DESCRIPTIONS

Different blade lines help you choose the right blade for the task.

- BASIC:** Cost effective
- FLEXIBLE:** Breakproof, long lifetime
- PROGRESSIVE:** Fast cutting through thin and thick material
- TOP:** Fast and efficient
- HEAVY:** Sturdy and precise

12,7MM (1/2") UNIVERSAL SHANK

Fits: AEG®, BLACK & DECKER®, BOSCH®, DEWALT®, FEIN®, FLEX®, HILTI®, MAKITA®, METABO®, MILWAUKEE®, PORTER CABLE®, RIDGID®, ROTHENBERGER®, RYOBI®, SKIL®.

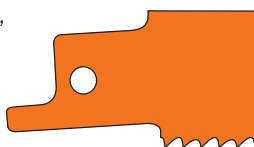

BLADE SHAPE & THICKNESS

Sabre Saw Blades vary in shape and thickness. These two characteristics are adjusted according to the demands of the application as well as the required flexibility. Rigorous applications such as cutting tube and pipe require thick robust blades, while less demanding applications require narrower blades.

Three Main Blade Categories:

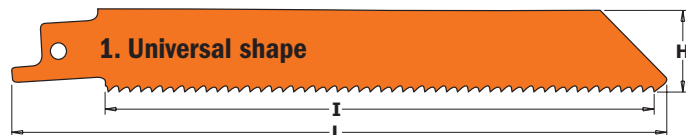

1. Universal shape

Universal blades are for general use. Their even width guarantees good cutting stability and excellent control. This enables straight edge cutting through many different materials.

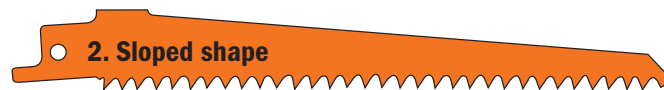

2. Sloped shape









Sloped blades are commonly used for cutting wood and for demolition applications. Their narrow tip allows for plunge and curve cutting. This shape is rarely used for metal, since the tip does not have the strength required for this application.



3. Scroll shape

Scroll blades are especially used for curve cutting. The narrower the blade, the smaller the radius it can cut.

Sabre Saw Blade Application Chart









Series	Material	Material Thickness 	Line	L	Fine Straight 	Coarse Straight 	Curve 	Fine Angle Cut 	Flush Cut 	Thin & Thick 	Demolition 	TPI	Page	
WOOD	Coarse wood (free of nails)	<100	Base			JS617K	JS617K					3	86	
	Pruning green wood	<175	Base			JS1111K						3	86	
	Coolant: dry MAX RPM 2500	<190	Top				JS1531L						5	86
		<250	Base				JS1617K						3	86
	Construction wood	<100	Top	150	JS644D		JS644D						6	86
	Coolant: dry MAX RPM 2500	<150	Progressive	200	JS2345X						JS2345X		6-10	86
		<150	Pallet	200	JS725VFR			JS725VFR		JS725VFR	JS725VFR		8-12	88
	Boards	<60	Top	150	JS644D		JS644D						6	86
	Coolant: dry MAX RPM 2500	<60	Progressive	200	JS2345X						JS2345X		6-10	86
		<60	Pallet	200	JS725VFR			JS725VFR		JS725VFR	JS725VFR		8-12	88
	Wooden wall cutout	<100	Top	150	JS644D		JS644D						6	86
	Coolant: dry MAX RPM 2500	<150	Progressive	200	JS2345X						JS2345X		6-10	86
		<150	Pallet	200	JS725VFR			JS725VFR		JS725VFR	JS725VFR		8-12	88
		<190	Top	240		JS1531L							5	86
	Plastic	<100	Top	150	JS644D		JS644D						6	86
Coolant: water MAX RPM 500	<150	Progressive	200	JS2345X						JS2345X		6-10	86	
	Wood with nails/metal	<100	Flexible	150	JS922HF							10	89	
Coolant: dry MAX RPM 2500	<100	Flexible	150	JS922VF								10-14	89	
	<100	Heavy	150	JS641HM	JS611DF	JS711DF						6	87, 93	
	<100	Heavy	150		JS610VF		JS610VF				JS610VF	5-8	87	
	<100	Heavy	150		JS956XHM		JS956XHM				JS956XHM	5-8	90	
	<150	Progressive	200		JS3456XF					JS3456XF		6-12	88	
	<150	Pallet	200	JS725VFR			JS725VFR		JS725VFR	JS725VFR		8-12	88	
	<175	Flexible	225	JS1122HF				JS1122HF				10	89	
	<175	Flexible	225	JS1122VF				JS1122HF				10-14	89	
	<175	Heavy	225		JS1111DF							6	87	
	<175	Heavy	225		JS1110VF		JS1110VF				JS1110VF	5-8	88	
	<175	Heavy	225		JS1156XHM		JS1156XHM				JS1156XHM	5-8	90	
	<175	Progressive	225		JS5678XF				JS5678XF			6-12	88	
	<250	Flexible	300	JS1222VF				JS1222VF				10-14	89	
	<250	Heavy	300		JS1210VF		JS1210VF				JS1210VF	5-8	88	
	<250	Heavy	300		JS1411DF							6	87	
Pallet	<100	Flexible	150	JS922HF	JS641HM							10	89, 93	
Coolant: dry MAX RPM 2500	<150	Pallet	200	JS725VFR			JS725VFR		JS725VFR	JS725VFR		8-12	88	
	<175	Flexible	225	JS1122HF				JS1122HF				10	89	
Wood, chipboard	<100	Heavy	150		JS611DF	JS711DF						6	87	
Coolant: dry MAX RPM 2500	<100	Heavy	150		JS610VF		JS610VF				JS610VF	5-8	87	
	<100	Heavy	150		JS956XHM		JS956XHM				JS956XHM	5-8	90	
	<150	Progressive	200		JS3456XF				JS3456XF			6-12	88	
	<150	Pallet	200	JS725VFR			JS725VFR		JS725VFR	JS725VFR		8-12	88	
	<175	Heavy	225		JS1111DF							6	87	
	<175	Heavy	225		JS1110VF		JS1110VF				JS1110VF	5-8	88	
	<175	Heavy	225		JS1156XHM		JS1156XHM				JS1156XHM	5-8	90	
	<175	Progressive	225		JS5678XF				JS5678XF			6-12	88	
	<250	Heavy	300		JS1210VF		JS1210VF				JS1210VF	5-8	88	
	<250	Heavy	300		JS1411DF							6	87	
Sheet metals	3~10	Flexible	150	JS922VF								10-14	89	
Coolant: cutting oil MAX RPM 500~2000	3~10	Flexible	225	JS1122VF				JS1122HF				10-14	89	
	3~10	Flexible	300	JS1222VF				JS1222VF				10-14	89	
	3~18	Progressive	200		JS3456XF				JS3456XF			6-12	88	
	<175	Progressive	225		JS5678XF				JS5678XF			6-12	88	
Pipes, profiles	<100	Flexible	150	JS922VF								10-14	89	
Coolant: cutting oil MAX RPM 1500	<150	Progressive	200		JS3456XF				JS3456XF			6-12	88	
	<175	Flexible	225	JS1122VF				JS1122HF				10-14	89	
	<175	Progressive	225		JS5678XF				JS5678XF			6-12	88	
	<250	Flexible	300	JS1222VF				JS1222VF				10-14	89	
Plastic, pipes, profiles	<100	Heavy	150		JS611DF	JS711DF						6	87	
Coolant: water MAX RPM 500	<150	Progressive	200		JS3456XF				JS3456XF			6-12	88	
	<175	Heavy	225		JS1111DF							6	87	
	<175	Progressive	225		JS5678XF				JS5678XF			6-12	88	
	<250	Heavy	300		JS1411DF							6	87	
Glass fiber reinforced plastic/epoxy	<50	Heavy	150		JS611DF	JS711DF						6	87	
Coolant: water MAX RPM 500	<60	Heavy	300		JS1411DF							6	87	
	<60	Heavy	150		JS610VF		JS610VF				JS610VF	5-8	87	
	<100	Heavy	150		JS956XHM		JS956XHM				JS956XHM	5-8	90	

WOOD

WOOD & METAL

Sabre Saw Blade Application Chart



Series	Material	Material Thickness  mm	Line	L	Fine Straight 	Coarse Straight 	Curve 	Fine Angle Cut 	Flush Cut 	Thin & Thick 	Demolition 	TPI	Page	
WOOD & METAL	Glass fiber reinforced plastic/epoxy Coolant: water MAX RPM 500	<60	Heavy	225		JS1111DF						6	87	
		<60	Heavy	225		JS1110VF		JS1110VF			JS1110VF	5-8	88	
		<175	Heavy	225			JS1156XHM		JS1156XHM			JS1156XHM	5-8	90
		<100	Flexible	150	JS922VF	JS641HM							10~14	89, 93
		<150	Progressive	200		JS3456XF					JS3456XF		6~12	88
		<175	Flexible	225	JS1122VF					JS1122HF			10~14	89
		<175	Progressive	225		JS5678XF					JS5678XF		6~12	88
		<250	Flexible	300	JS1222VF					JS1222VF			10~14	89
	<250	Heavy	300		JS1210VF		JS1210VF			JS1210VF	5-8	88		
METAL	Sheet, perforated metals, (thin & thick) Coolant: dry MAX RPM 500~2000	0,7~3	Flexible	150	JS922AF							24	92	
		0,7~3	Flexible	225	JS1122AF				JS1122AF			24	92	
		1~8	Progressive	150	JS123XF					JS123XF		8~14	91	
		1,5~4	Flexible	150	JS922EF							18	92	
		1,5~4	Flexible	225	JS1122EF					JS1122EF		18	92	
		2~10	Heavy	150	JS925VF							JS925VF	10~14	91
		2~10	Heavy	200	JS1025VF							JS1025VF	10~14	91
		2~10	Heavy	225	JS1125VF							JS1125VF	10~14	91
		2~10	Heavy	300	JS1125VF							JS1225VF	10~14	91
		3~8	Flexible	150	JS922BF								14	92
		3~8	Flexible	225	JS1122BF					JS1122BF			14	92
		4~12	Heavy	150			JS920CF		JS920CF			JS920CF	9	90
	4~12	Heavy	150			JS955CHM		JS955CHM			JS955CHM	9	90	
	4~12	Heavy	225			JS1120CF		JS1120CF			JS1120CF	9	91	
	4~12	Heavy	225			JS1155CHM		JS1155CHM			JS1155CHM	9	90	
	Pipes, profiles, thin-walled (open & closed) Coolant: dry MAX RPM 500~2000	<100	Flexible	150	JS922AF								24	92
		<100	Flexible	150	JS922EF							18	92	
		<100	Progressive	150	JS123XF					JS123XF		8~14	91	
		<100	Heavy	150	JS925VF						JS925VF	10~14	91	
		<150	Heavy	200	JS1025VF						JS1025VF	10~14	91	
		<175	Flexible	225	JS1122AF				JS1122AF			24	92	
		<175	Flexible	225	JS1122EF				JS1122EF			18	92	
		<175	Heavy	225	JS1125VF						JS1125VF	10~14	91	
		<250	Heavy	300	JS1225VF						JS1225VF	10~14	91	
		<250	Heavy	300	JS1225VF						JS1225VF	10~14	91	
	Pipes, profiles, thick-walled (open & closed) Coolant: dry MAX RPM 500~2000	<100	Flexible	150	JS922BF								14	92
		<100	Progressive	150	JS123XF					JS123XF		8~14	91	
		<100	Heavy	150	JS925VF						JS925VF	10~14	91	
		<100	Heavy	150			JS920CF		JS920CF		JS920CF	9	90	
		4~12	Heavy	150			JS955CHM		JS955CHM		JS955CHM	9	90	
		<150	Heavy	200	JS1025VF						JS1025VF	10~14	91	
		<175	Flexible	225	JS1122BF				JS1122BF			14	92	
<175		Heavy	225	JS1125VF						JS1125VF	10~14	91		
<175		Heavy	225			JS1120CF		JS1120CF		JS1120CF	9	91		
4~12		Heavy	225			JS1155CHM		JS1155CHM		JS1155CHM	9	90		
<250	Heavy	300	JS1225VF						JS1225VF	10~14	91			
Pipes, profiles (solid) Coolant: cutting oil MAX RPM 500~2000	<100	Progressive	150	JS123XF					JS123XF		8~14	91		
	<100	Flexible	150	JS922BF							14	92		
	<100	Heavy	150			JS920CF		JS920CF		JS920CF	9	90		
	4~12	Heavy	150			JS955CHM		JS955CHM		JS955CHM	9	90		
	<175	Flexible	225	JS1122BF					JS1122BF		14	92		
	<175	Heavy	225			JS1120CF		JS1120CF		JS1120CF	9	91		
	4~12	Heavy	225			JS1155CHM		JS1155CHM		JS1155CHM	9	90		
SPECIAL	Plasterboard	<100	Heavy	150	JS641HM	JS611DF	JS711DF					6	87,93	
	Fiber Cement panels	<175	Special	225		JS1141HM		JS1141HM				3	93	
		<215	Special	305		JS1243HM		JS1243HM				2	93	
		<250	Special	300		JS1241HM		JS1241HM				3	93	
		<365	Special	455		JS2243HM		JS2243HM				2	93	
	Porous concrete, red brick	<175	Special	225		JS1141HM		JS1141HM				3	93	
		<215	Special	305		JS1243HM		JS1243HM				2	93	
		<250	Special	300		JS1241HM		JS1241HM				3	93	
		<365	Special	455		JS2243HM		JS2243HM				2	93	
	Ice, frozen, meat, bone	<250	Special	300		JS1211K						3	94	

Tip: Using a lubricant can extend blade lifetime up to 500%.

Sabre Saw Blades



JS617K

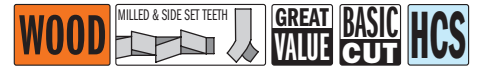

PACK Quantity	L mm	I mm	H mm	K mm	TS mm	TPI		ORDER NO. Universal Shank
5	150	130	19	1,25	8,5	3	10	JS617K-5



Cuts coarse wood, free of nails (<100mm), pruning green wood (diameter <100mm), excellent for curved and plunge cutting.

JS1111K



PACK Quantity	L mm	I mm	H mm	K mm	TS mm	TPI		ORDER NO. Universal Shank
5	225	205	19	1,25	8,5	3	10	JS1111K-5



Coarse wood, free of nails (<175mm), firewood (diameter <175mm).

JS1617K

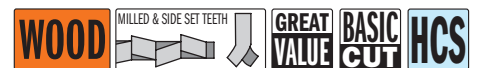

PACK Quantity	L mm	I mm	H mm	K mm	TS mm	TPI		ORDER NO. Universal Shank
5	300	280	19	1,25	8,5	3	10	JS1617K-5



Coarse wood, free of nails (<250mm), pruning green wood (diameter <250mm).

JS644D

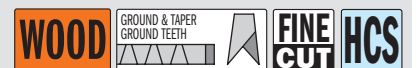

PACK Quantity	L mm	I mm	H mm	K mm	TS mm	TPI		ORDER NO. Universal Shank
5	150	130	19	1,25	4,3	6	10	JS644D-5



Cuts construction wood (<100mm), wooden wall panels (<100mm), chipboard, MDF (6~60mm), plywood, plastic (<100mm). Special for plunge cutting.

JS1531L

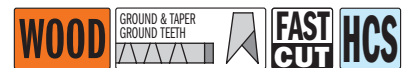

PACK Quantity	L mm	I mm	H mm	K mm	TS mm	TPI		ORDER NO. Universal Shank
5	240	220	19	1,50	5	5	10	JS1531L-5



Coarse wood, free of nails (<190mm), pruning green wood (diameter <190mm), firewood (diameter <190mm).

JS2345X



PACK Quantity	L mm	I mm	H mm	K mm	TS mm	TPI		ORDER NO. Universal Shank
5	200	180	19	1,25	2,4-4	6-10	10	JS2345X-5



Cuts construction wood (<150mm), chipboard, MDF (6~60mm), plywood, plastic (<150mm), wooden wall (<150mm). Effortless fine cutting.

Sabre Saw Blades



JS611DF

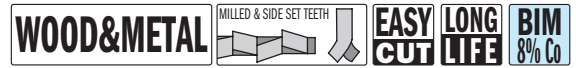

PACK Quantity	L mm	I mm	H mm	K mm	TS mm	TPI		ORDER NO. Universal Shank
5	150	130	19	1,25	4,3	6	10	JS611DF-5

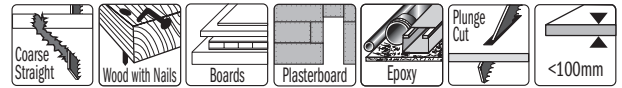

Cuts wood with nails/embedded metal (<100mm), plastic profiles (<100mm), fiberglass and epoxy (<50mm), wood and metal window frames. Special for plunge cutting.

JS711DF

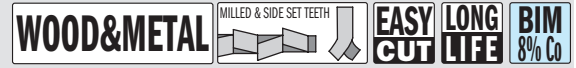

PACK Quantity	L mm	I mm	H mm	K mm	TS mm	TPI		ORDER NO. Universal Shank
5	150	130	12	1,25	4,3	6	10	JS711DF-5

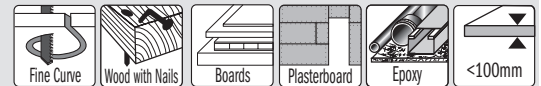

Cuts wood with nails/embedded metal (<100mm), fiberglass and epoxy (<50mm). Excellent for curved cuts.

JS1111DF



PACK Quantity	L mm	I mm	H mm	K mm	TS mm	TPI		ORDER NO. Universal Shank
5	225	205	19	1,25	4,3	6	10	JS1111DF-5
20	225	205	19	1,25	4,3	6	5	JS1111DF-20



For cutting wood with nails/embedded metal, chipboard (<175mm), plastic profiles (<175mm), fiberglass and epoxy (<50mm).

JS1411DF

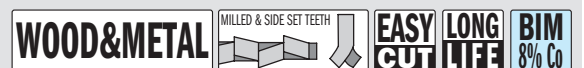

PACK Quantity	L mm	I mm	H mm	K mm	TS mm	TPI		ORDER NO. Universal Shank
5	300	280	19	1,25	4,3	6	10	JS1411DF-5

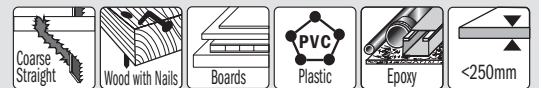

Cuts wood with nails/embedded metal, chipboard (<250mm), fiberglass and epoxy (<60mm).

JS610VF

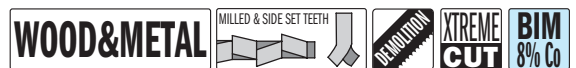

PACK Quantity	L mm	I mm	H mm	K mm	TS mm	TPI		ORDER NO. Universal Shank
5	150	130	22	1,60	3,2-5	5-8	10	JS610VF-5

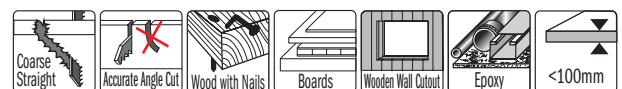

Cuts wood with nails/metal, wood, chipboard (<100mm), fiberglass and epoxy (<100mm), wood and metal wall cut-outs, (<100mm). Excellent for rescue/demolition work.

Sabre Saw Blades



JS1110VF



Pack Quantity	L mm	I mm	H mm	K mm	TS mm	TPI		ORDER NO. Universal Shank
5	225	205	22	1,60	3,2-5	5-8	10	JS1110VF-5
20	225	205	22	1,60	3,2-5	5-8	5	JS1110VF-20



For cutting wood with nails/embedded metal, chipboard (<175mm), fiberglass and epoxy, wood and metal wall cut-outs (<175mm). For rescue and demolition work.

JS1210VF



Pack Quantity	L mm	I mm	H mm	K mm	TS mm	TPI		ORDER NO. Universal Shank
5	300	280	22	1,60	3,2-5	5-8	10	JS1210VF-5



Cuts wood with nails/embedded metal, wood, chipboard (<250mm), fiberglass and epoxy (<250mm), wood and metal wall cut-outs (<250mm).

JS3456XF



Pack Quantity	L mm	I mm	H mm	K mm	TS mm	TPI		ORDER NO. Universal Shank
5	200	180	19	1,25	2,1-4,3	6-12	10	JS3456XF-5
20	200	180	19	1,25	2,1-4,3	6-12	5	JS3456XF-20

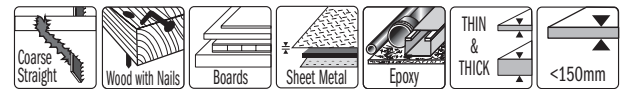

For cutting wood with nails/embedded metal (<150mm), sheet metal, pipe and aluminium profiles from (3~18mm) in thickness, fiberglass and epoxy (<150mm).

JS5678XF



Pack Quantity	L mm	I mm	H mm	K mm	TS mm	TPI		ORDER NO. Universal Shank
5	225	205	25	1,27	2,1-4,3	6-12	10	JS5678XF-5
20	225	205	25	1,27	2,1-4,3	6-12	5	JS5678XF-20



For cutting wood with nails or metal, chipboard (<175mm), sheet metal, aluminium profiles (3-18mm), glass fibre reinforced plastic/epoxy (<175mm).

JS725VFR



Pack Quantity	L mm	I mm	H mm	K mm	TS mm	TPI		ORDER NO. Universal Shank
5	200	180	19	1,27	2,1-3,2	8-12	10	JS725VFR-5
20	200	180	19	1,27	2,1-3,2	8-12	5	JS725VFR-20



Special saw blade for pallet repair. Cutting depth <150mm. Optimized for reduced vibration.

Sabre Saw Blades



JS922HF

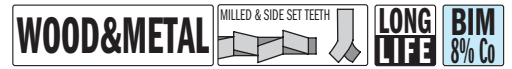

PACK Quantity	L mm	I mm	H mm	K mm	TS mm	TPI		ORDER NO. Universal Shank
5	150	130	19	0,90	2,5	10	10	JS922HF-5

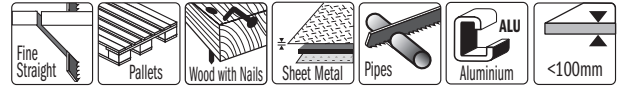

For pallet repair, wood with nails/embedded metal (<100mm), sheet metal, pipe, aluminium profiles (3~12mm).

JS1122HF

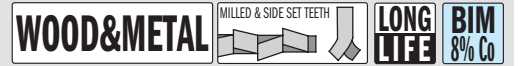

PACK Quantity	L mm	I mm	H mm	K mm	TS mm	TPI		ORDER NO. Universal Shank
5	225	205	19	0,90	2,5	10	10	JS1122HF-5
20	225	205	19	0,90	2,5	10	5	JS1122HF-20

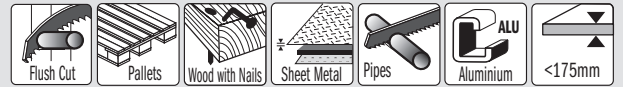

For pallet repair, wood with nails/embedded metal (<175mm), sheet metal, pipe, aluminium profiles (3~12mm). Flexible flush cutting.

JS922VF



PACK Quantity	L mm	I mm	H mm	K mm	TS mm	TPI		ORDER NO. Universal Shank
5	150	130	19	0,90	1,8-2,6	10-14	10	JS922VF-5



Cuts wood with nails/embedded metal (<100mm), sheet metal, pipe and aluminium profiles (3~10mm), fiberglass and epoxy (<100mm).

JS1122VF

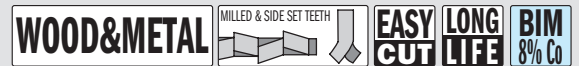

PACK Quantity	L mm	I mm	H mm	K mm	TS mm	TPI		ORDER NO. Universal Shank
5	225	205	19	0,90	1,8-2,6	10-14	10	JS1122VF-5



Cuts wood with nails/embedded metal (<175mm), sheet metal, aluminium profiles (3~10mm), fiberglass and epoxy (<175mm). Flexible flush cutting.

JS1222VF



PACK Quantity	L mm	I mm	H mm	K mm	TS mm	TPI		ORDER NO. Universal Shank
5	300	280	19	0,90	1,8-2,6	10-14	10	JS1222VF-5



Cuts wood with nails/embedded metal (<250mm), sheet metal, aluminium profiles (3~10mm), fiberglass and epoxy (<250mm). Flexible flush cutting

Sabre Saw Blades



JS956XHM HW TOOTH

new



Pack Quantity	L mm	I mm	H mm	K mm	TS mm	TPI		ORDER NO. Universal Shank
1	150	130	24	1,2	3-4	6-8	10	JS956XHM-3

For cutting wood with nails or metal (nails/metal hardness up to 40 HRC), repairing pallets, plasterboard, plastics, glass fibre reinforced plastic/epoxy, fibre cement (<100mm). For rescue and demolition work.



JS1156XHM HW TOOTH

new



Pack Quantity	L mm	I mm	H mm	K mm	TS mm	TPI		ORDER NO. Universal Shank
1	225	205	24	1,2	3-4	6-8	10	JS1156XHM-3

For cutting wood with nails or metal (nails/metal hardness up to 40 HRC), repairing pallets, plasterboard, plastics, glass fibre reinforced plastic/epoxy, fibre cement (<175 mm). For rescue and demolition work.



JS955CHM HW TOOTH

new



Pack Quantity	L mm	I mm	H mm	K mm	TS mm	TPI		ORDER NO. Universal Shank
1	150	130	24	1,2	3	8	10	JS955CHM-3

For cutting thick sheet metal (4-12mm), pipes & profiles (<100mm), plastics, glass fibre reinforced plastic/epoxy, fibre cement (<100mm), wood with nails or metal.



JS1155CHM HW TOOTH

new



Pack Quantity	L mm	I mm	H mm	K mm	TS mm	TPI		ORDER NO. Universal Shank
1	225	205	24	1,2	3	8	10	JS1155CHM-3

For cutting thick sheet metal (4-12mm), pipes & profiles (<175mm), plastics, glass fibre reinforced plastic/epoxy, fibre cement (<175mm), wood with nails or metal.



JS920CF



Pack Quantity	L mm	I mm	H mm	K mm	TS mm	TPI		ORDER NO. Universal Shank
5	150	130	22	1,60	2,9	9	10	JS920CF-5

Cuts thick sheet metal (4-12mm), thick-walled pipe and profiles (<100mm). Ideal for pipe cutting, for rescue/demolition work. Powerful coarse cutting.

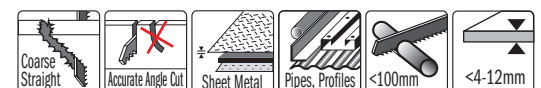

Sabre Saw Blades



JS1120CF



PACK Quantity	L mm	I mm	H mm	K mm	TS mm	TPI		ORDER NO.
5	225	205	22	1,60	2,9	9	10	JS1120CF-5
20	225	205	22	1,60	2,9	9	5	JS1120CF-20

For cutting thick sheet metal (4~12mm), thick-walled pipe and profiles (<175mm). Ideal for pipe cutters, for rescue/demolition work. Powerful coarse cutting.

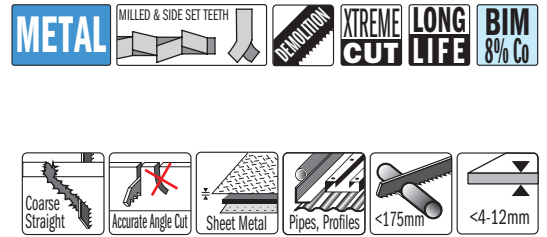

JS123XF



PACK Quantity	L mm	I mm	H mm	K mm	TS mm	TPI		ORDER NO.
5	150	130	19	0,90	1,8-3,2	8-14	10	JS123XF-5

Cuts thin sheet metal (1~8mm) pipes and profiles (diameter <100mm).

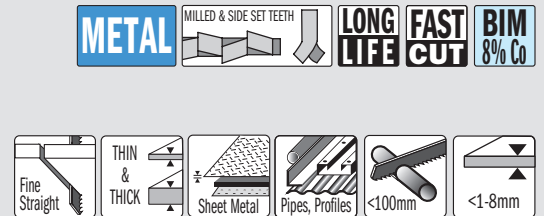

JS925VF



PACK Quantity	L mm	I mm	H mm	K mm	TS mm	TPI		ORDER NO.
5	150	130	19	1,25	1,8-2,6	10-14	10	JS925VF-5

Cuts medium-thick to thick sheet metal (2~10mm), thin and thick-walled pipe and profiles (<100mm). Ideal for demolition work in metal. Fine effortless cutting.

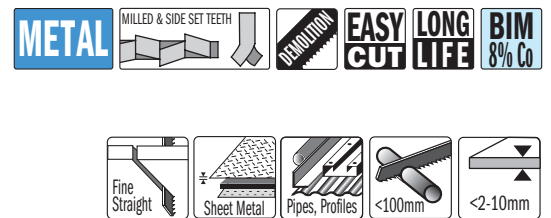

JS1025VF

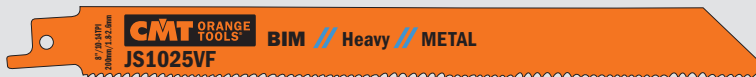

PACK Quantity	L mm	I mm	H mm	K mm	TS mm	TPI		ORDER NO.
5	200	180	19	1,25	1,8-2,6	10-14	10	JS1025VF-5

Cuts medium-thick to thick sheet metal (2~10mm), thin and thick-walled pipe and profiles (<150mm). Ideal for demolition work on metal. Fine effortless cutting.



JS1125VF



PACK Quantity	L mm	I mm	H mm	K mm	TS mm	TPI		ORDER NO.
5	225	205	19	1,25	1,8-2,6	10-14	10	JS1125VF-5

Cuts medium-thick to thick sheet metal (2~10mm), thin and thick-walled pipe and profiles (<175mm). Ideal for demolition work on metal. Fine effortless cutting.

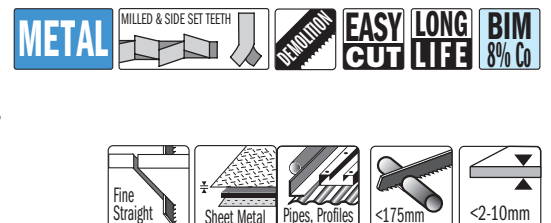

JS1225VF



PACK Quantity	L mm	I mm	H mm	K mm	TS mm	TPI		ORDER NO.
5	300	280	19	1,25	1,8-2,6	10-14	10	JS1225VF-5

Cuts medium-thick to thick sheet metal (2~10mm), thin and thick-walled pipe and profiles (<250mm). Ideal for demolition work in metal. Fine effortless cutting.

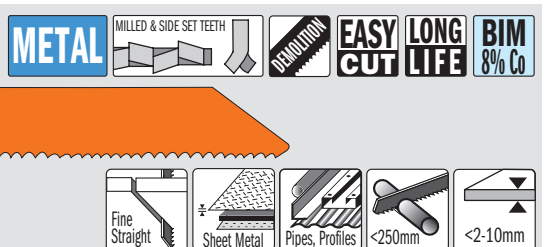

Sabre Saw Blades



JS922BF



PACK Quantity	L mm	I mm	H mm	K mm	TS mm	TPI		ORDER NO. Universal Shank
5	150	130	19	0,90	1,8	14	10	JS922BF-5
20	150	130	19	0,90	1,8	14	5	JS922BF-20



Cuts thin sheet metal (3~8mm), thin pipe and profiles (diameter <100mm). Fine effortless cutting.

JS1122BF



PACK Quantity	L mm	I mm	H mm	K mm	TS mm	TPI		ORDER NO. Universal Shank
5	225	205	19	0,90	1,8	14	10	JS1122BF-5
20	225	205	19	0,90	1,8	14	5	JS1122BF-20



Cuts thin sheet metal (3~8mm), thin pipe and profiles (diameter <175mm). Fine effortless cutting. Flexible flush cuts.

JS922EF



PACK Quantity	L mm	I mm	H mm	K mm	TS mm	TPI		ORDER NO. Universal Shank
5	150	130	19	0,90	1,4	18	10	JS922EF-5
20	150	130	19	0,90	1,4	18	5	JS922EF-20



Cuts thin sheet metal (1,5~4mm), pipe and profiles (diameter <100mm).

JS1122EF



PACK Quantity	L mm	I mm	H mm	K mm	TS mm	TPI		ORDER NO. Universal Shank
5	225	205	19	0,90	1,4	18	10	JS1122EF-5
20	225	205	19	0,90	1,4	18	5	JS1122EF-20



Cuts thin sheet metal (1,5~4mm), pipe and profiles (diameter <175mm). Flexible flush cuts.

JS922AF



PACK Quantity	L mm	I mm	H mm	K mm	TS mm	TPI		ORDER NO. Universal Shank
5	150	130	19	0,90	1	24	10	JS922AF-5



Cuts thin sheet metal (0,7~3mm), fine pipe and profiles (diameter <100mm). Effortless fine cuts.

JS1122AF



PACK Quantity	L mm	I mm	H mm	K mm	TS mm	TPI		ORDER NO. Universal Shank
5	225	205	19	0,90	1	24	10	JS1122AF-5



Cuts thin sheet metal (0,7~3mm), fine pipe and profiles (diameter <175mm). Effortless fine cuts.

Sabre Saw Blades



JS641HM HW TOOTH



PACK Quantity	L mm	I mm	H mm	K mm	TS mm	TPI		ORDER NO. Universal Shank
2	150	130	19	1,25	4,3	6	25	JS641HM-2

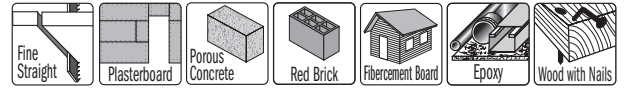

Cuts porous concrete, red brick, fiber cement, plasterboard, fiber reinforced plastic and epoxy (<100mm), wood & nails, ETERNIT®, MDF.

JS1141HM HW TOOTH



PACK Quantity	L mm	I mm	H mm	K mm	TS mm	TPI		ORDER NO. Universal Shank
1	225	205	22	1,2	8,5	3	10	JS1141HM-2

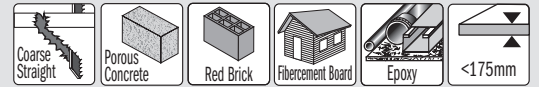

For cutting porous concrete, red brick, fibre cement (10-175mm), glass fibre reinforced plastic/epoxy (<100mm). Fast Cut.

JS1241HM HW TOOTH



PACK Quantity	L mm	I mm	H mm	K mm	TS mm	TPI		ORDER NO. Universal Shank
1	300	280	22	1,5	8,5	3	25	JS1241HM-2

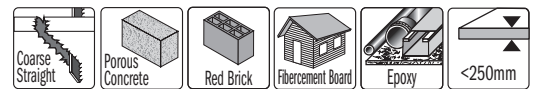

For cutting porous concrete, red brick, fibre cement (10-250mm), glass fibre reinforced plastic/epoxy (<100mm). Fast Cut.

JS1243HM HW TOOTH

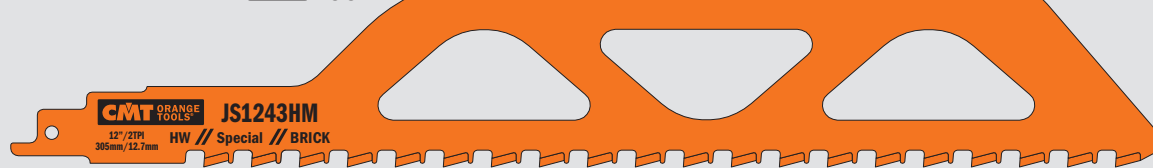

PACK Quantity	L mm	I mm	H mm	K mm	TS mm	TPI		ORDER NO. Universal Shank
1	305	250	50	1,50	12,7	2	25	JS1243HM

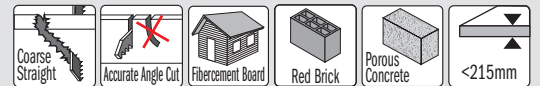

Cuts medium-sized brick up to 215mm in thickness.

JS2243HM HW TOOTH



PACK Quantity	L mm	I mm	H mm	K mm	TS mm	TPI		ORDER NO. Universal Shank
1	455	400	50	1,50	12,7	2	25	JS2243HM

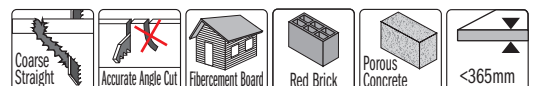

Cuts large brick up to 365mm in thickness.

Sabre Saw Blades

JS1211K

new

SPECIAL FAST CUT INOX



Pack Quantity	L mm	I mm	H mm	K mm	TS mm	TPI	ORDER NO. Universal Shank
5	300	275	19	1,2	8,5	3	10 JS1211K-5

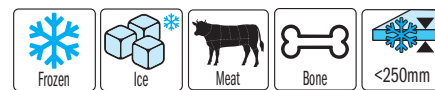

Ideal for sectioning and cutting meat, bone, frozen products and ice up to 250mm in thickness.

25-Piece Reciprocating Saw Blade Set

new

JS025

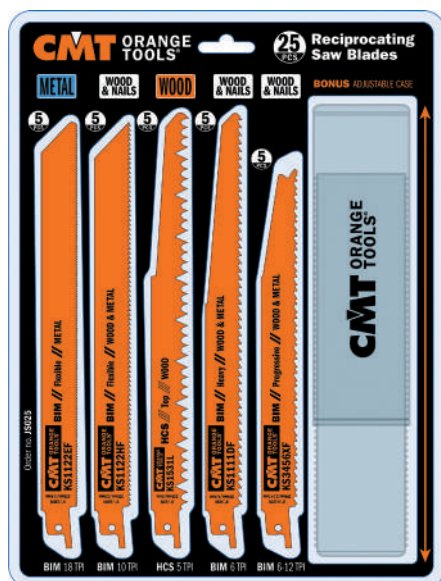

5 PCS	KS1122EF BIM	METAL	TPI 18 1.4mm	Fine Straight	Sheet Metal	Flush cut	Pipes, profiles	<175mm	<1.5-4mm <1/16"-3/32"	LONG LIFE
5 PCS	KS1122HF BIM	WOOD & NAILS	TPI 10 2.5mm	Wood with nails	Sheet Metal	Flush cut	Pallets	Pipes	<175mm <9-1/8"	LONG LIFE
5 PCS	KS1531L HCS	WOOD	TPI 5 5mm	Coarse Straight	Nail-free coarse wood	Pruning		<190mm <1-1/2"	FAST CUT	
5 PCS	KS1111DF BIM	WOOD & NAILS	TPI 6 4.3mm	Wood with nails	Boards	PVC	Plastic	Epoxy	<175mm <9-1/8"	EASY CUT LONG LIFE
5 PCS	KS3456XF BIM	WOOD & NAILS	TPI 6-12 2.1-4.3mm	Wood with nails	Boards	Sheet Metal	Epoxy	THIN & THICK	<150mm <9-1/8"	LONG LIFE

Handle for Reciprocating Saw

new

Handle for reciprocating saw blades with 12.7mm (1/2") universal shank. Practical, functional, ergonomic and featuring non-slip material. Screw for mechanical fastening.

JS001

DESCRIPTION	ORDER NO.
Handle for reciprocating saw	JS001



TOOLS FOR MULTI-CUTTERS



PRODUCTS

PAGE

STARLOCK®/STARLOCKPLUS®/STARLOCKMAX® Arbors

Radial Saw Blades for Multi-Mat & Wood&Metal	99
Plunge Cut & Precision for Wood	100~102
Plunge Cut for Wood&Nails	102~105
Blades for Wood&Metal	103-104
Blades for Metal	105
Blades for Masonry	106
Rasp & Saw for Masonry	107
Scraper for Multi-Mat	108
Blades for Special Materials	109
Sets for Multi-Cutters	109
Delta Sanding Pad	110
Polishing Fleece	110
Sandpaper Sheet	110

Universal/SuperCut Arbors

Plunge Cut & Precision for Wood	112-113
Radial Saw Blade for Wood	114
Plunge & Flush-Cut for Wood&Metal	114~116
Radial Saw Blade for Wood&Metal	116
Scraper for Multi-Mat	117
Radial Saw Blade for Masonry	117-118
Rasp & Saw for Masonry	118-119
Carbide Grit Mortar Remover for Masonry	118
Delta Sanding Pad	119
Sets for Multi-Cutters	120

CMT11

Oscillating Multi-Tool



381



MAXIMIZE YOUR PERFORMANCE!



HIGH CARBON STEEL
for cutting wood
and plastic.



BI-METAL WITH 8% COBALT
for cutting metal,
nail embedded wood
and plastic.



**BI-METAL WITH 8% COBALT
WITH TITANIUM COATING**
for cutting metal, nail
embedded wood and
plastic, providing extreme
performance and 30%
longer lifetime.



TUNGSTEN CARBIDE TIPPED
for cutting wood, screws and nails,
fiber cement board, plasterboard,
plastic, sheet metal, copper,
aluminium and stainless steel.
Doubles tool lifetime.



TUNGSTEN CARBIDE GRIT COATED
for routing joints and grooves,
smaller cutouts, and routing recesses in
a variety of materials: tiles, plasterboard,
porous concrete, construction materials,
epoxy and fiberglass.



DIAMOND GRIT COATED
for routing joints and grooves, smaller
cutouts, and routing recesses in a variety
of materials: tiles, plasterboard, porous
concrete, construction materials, epoxy
and fiberglass. Extreme performance and
longer lifetime.

SAWING & CUTTING



CUTTING & SCRAPING



GRINDING, RASPING & SEPARATING



MULTI MATERIALS



SANDING & POLISHING



APPLICATIONS

- GRINDING
- SAWING
- JOINT CLEANING
- PLASTIC CUTTING
- CARPET REMOVAL
- PLUNGE CUTTING
- WOOD CUTTING
- CUTTING LAMINATE SHEETS
- TUBE TRIMMING
- NAIL CUTTING

THE RIGHT BLADE FOR THE BEST RESULTS!

Quick reference charts and pictograms help you choose the right blade for your application.

WOOD

**WOOD&NAILS
WOOD&METAL**

METAL

MULTI-MAT

MASONRY

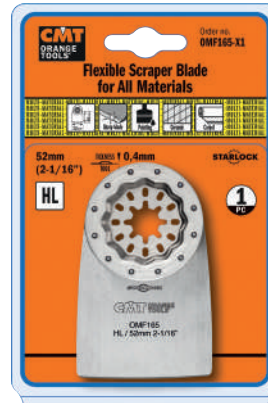

STARLOCK®: THE NEW SYSTEM FOR MULTI-CUTTER POWER TOOLS

STARLOCK® enables extremely reliable and fast accessory changes in a record time of less than 3 seconds. It also guarantees a secure fit and therefore maximum power transfer. The result: up to around 35% faster performance depending on the accessory, noticeably improved precision and reduced noise. To protect the individual tools from overload and damage, the system is divided into 3 performance classes: **STARLOCK®**, **STARLOCKPLUS®** and **STARLOCKMAX®**. The performance potential of a multi-cutter tool can only be fully exploited with the right accessories. The exceptional quality and service life of our accessories combined with the perfect results delivers excellent value for money.

POWERTOOL COMPATIBILITY CHART FOR CMT MULTI-CUTTER ACCESSORIES	STARLOCK	STARLOCK PLUS	STARLOCK MAX
	SL	SLP	SLM
AEG®	●		
BOSCH®	●	●	●
CMT®	●		
CRAFTSMAN®	●	●	
DEWALT®	●		
DREMEL®	●		
EINHELL®	●		
FEIN® MULTITALENT®/MULTIMASTER®	●	●	
FEIN® SUPERCUT AUTOMOTIVE/CONSTRUCTION	●	●	●
FESTOOL® VECTURO®	●	●	●
HITACHI®	●		
MAKITA®	●	●	
METABO®	●		
MILWAUKEE®	●	●	
RIDGID®	●		
ROCKWELL®	●	●	
RYOBI®	●	●	
SKIL®	●	●	
WORX®	●		

Some brands may require an adapter

OMF113 STARLOCK

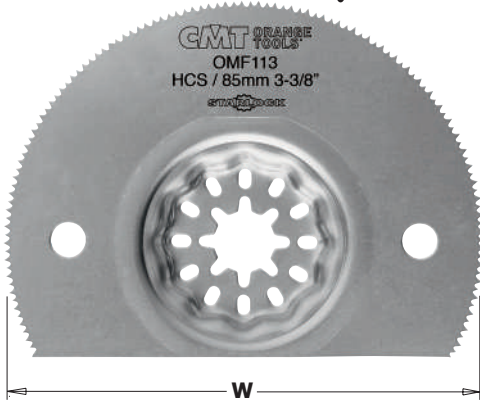

85mm Radial Saw Blade for Soft Materials, Segmented

- FEATURES:** HCS with hardened teeth.
MATERIAL: Soft materials only.
APPLICATION: Segmented, ideal for corners, edges, flush to the surface. Ideal for corners and edges.

MULTI-MAT **HCS**

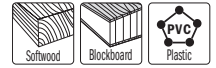

Pack Quantity	W mm	K mm	TS mm	TPI		ORDER NO. STARLOCK®
1 in clamshell	85	0,8	1,5	17	100	OMF113-X1
5 in clamshell	85	0,8	1,5	17	15	OMF113-X5

OMF106 STARLOCK

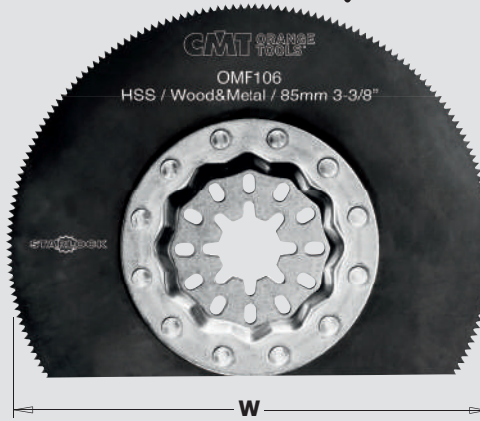

85mm Radial Saw Blade for Wood&Metal, Segmented

- FEATURES:** HSS with metal toothing. Clean and narrow cutting line.
MATERIAL: Suitable for applications on plastic, fibreglass, wood, glazing compound, brass, bronze, GFRP, non-ferrous materials and sheet metal up to 2mm in thickness.
APPLICATION: Wide range of applications. Ideal for corners and edge work as well as finishing cuts.

WOOD&METAL **HSS**



Pack Quantity	W mm	K mm	TS mm	TPI		ORDER NO. STARLOCK®
1 in clamshell	85	0,7	1,34	19	100	OMF106-X1
5 in clamshell	85	0,7	1,34	19	50	OMF106-X5

OMF174 STARLOCK



85mm Circular Saw Blade for Wood&Metal. Long Life

- FEATURES:** Reinforced teeth with Bi-metal 8% Cobalt for long life.
MATERIAL: For sheet metal up to 2mm, plastics, fibreglass, CFRP, wood, glazing compound, brass, bronze.
APPLICATION: Circular shape for increased cost-effectiveness.

WOOD&METAL **BIM 8% Co**



Pack Quantity	W mm	K mm	TS mm	TPI		ORDER NO. STARLOCK®
1 in clamshell	85	0,7	1,27	20	100	OMF174-X1
5 in clamshell	85	0,7	1,27	20	50	OMF174-X5

OMF133 STARLOCK



35mm Plunge Cut Blade for Wood

FEATURES: HCS hardened fine teeth. Narrow waisted to ensure good swarf removal.

MATERIAL: For all wood products, plasterboard and plastics.

APPLICATION: Wide range of applications: outstanding cutting speed and quality.



PACK Quantity	W mm	I mm	TS mm	TPI		ORDER NO. STARLOCK®
1 in clamshell	35	50	1,4	18	70	OMF133-X1
5 in clamshell	35	50	1,4	18	34	OMF133-X5
50 in masterpack	35	50	1,4	18	8	OMF133-X50

OMF126 STARLOCK

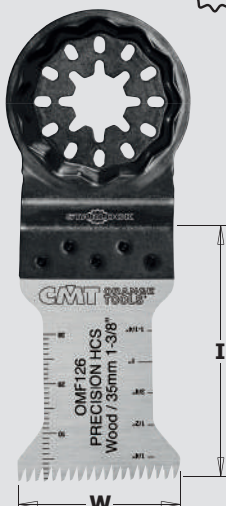

35mm Precision Cut Blade with Japanese Tothing for Wood

FEATURES: HCS hardened featuring double-row pattern "Japanese tothing".

MATERIAL: For wood products, plasterboard and soft plastics.

APPLICATION: Excellent cutting quality and speed and outstanding precision.

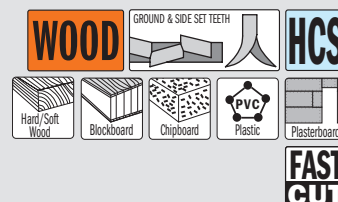

PACK Quantity	W mm	I mm	TS mm	TPI		ORDER NO. STARLOCK®
1 in clamshell	35	50	1,75	14	70	OMF126-X1
5 in clamshell	35	50	1,75	14	34	OMF126-X5
50 in masterpack	35	50	1,75	14	8	OMF126-X50

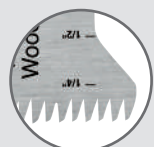

JAPANESE TOTHING

OMF233 STARLOCK



45mm Precision Cut Blade with Japanese Tothing for Wood

FEATURES: HCS hardened featuring double-row pattern "Japanese tothing".

MATERIAL: For all wood products, plasterboard and soft plastics.

APPLICATION: Excellent cutting quality and speed, outstanding precision. Medium width waist for a wide range of applications.

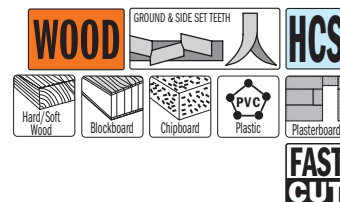

PACK Quantity	W mm	I mm	TS mm	TPI		ORDER NO. STARLOCK®
1 in clamshell	45	50	1,75	14	70	OMF233-X1
5 in clamshell	45	50	1,75	14	34	OMF233-X5
50 in masterpack	45	50	1,75	14	8	OMF233-X50

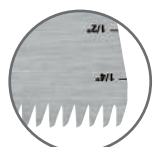

JAPANESE TOTHING

OMF230 STARLOCK



65mm Precision Cut Blade with Japanese Tothing for Wood

- FEATURES:** HCS hardened featuring Japanese tothing.
- MATERIAL:** For all wood products up to 50mm, plasterboard and soft plastics.
- APPLICATION:** Excellent cutting quality and speed and outstanding precision. Medium width for a variety of applications.

WOOD GROUND & SIDE SET TEETH **HCS**

Hard/Soft Wood Blockboard Chipboard PVC Plastic Plasterboard

FAST CUT

PACK Quantity	W mm	I mm	TS mm	TPI		ORDER NO. STARLOCK®
1 in clamshell	65	50	1,75	14	70	OMF230-X1
5 in clamshell	65	50	1,75	14	34	OMF230-X5
50 in masterpack	65	50	1,75	14	8	OMF230-X50

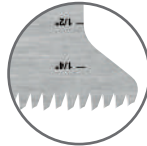

JAPANESE TOTHING

OMF205 STARLOCK

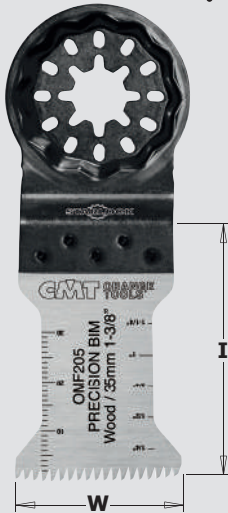

35mm Precision Cut Blade with Japanese tothing for Wood. Long Life

- FEATURES:** Reinforced teeth with Bi-metal 8% Cobalt featuring double-row "Japanese tothing". Guaranteed long life.
- MATERIAL:** For all wood materials up to 50mm, plasterboard and soft plastics.
- APPLICATION:** Wide range of applications. Medium width waist for outstanding cutting quality and speed.

WOOD GROUND & SIDE SET TEETH **BIM 8% Co**

Hard/Soft Wood Blockboard Chipboard PVC Plastic Plasterboard

LONG LIFE **FAST CUT**

PACK Quantity	W mm	I mm	TS mm	TPI		ORDER NO. STARLOCK®
1 in clamshell	35	50	1,75	14	70	OMF205-X1
5 in clamshell	35	50	1,75	14	34	OMF205-X5
50 in masterpack	35	50	1,75	14	8	OMF205-X50

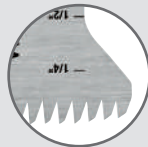

JAPANESE TOTHING
Reduced tooth height for longer lifetime

OMF232 STARLOCK



45mm Precision Cut Blade with Japanese Tothing for Wood. Long Life

- FEATURES:** Reinforced teeth with Bi-metal 8% Cobalt featuring double-row "Japanese tothing". Guaranteed long life.
- MATERIAL:** For all wood products up to 50mm, blockboard, plasterboard and soft plastics.
- APPLICATION:** Wide range of applications. Medium width waist for outstanding cutting speed and maximum precision.

WOOD GROUND & SIDE SET TEETH **BIM 8% Co**

Hard/Soft Wood Blockboard Chipboard PVC Plastic Plasterboard

LONG LIFE **FAST CUT**

PACK Quantity	W mm	I mm	TS mm	TPI		ORDER NO. STARLOCK®
1 in clamshell	45	50	1,75	14	70	OMF232-X1
5 in clamshell	45	50	1,75	14	34	OMF232-X5
50 in masterpack	45	50	1,75	14	8	OMF232-X50

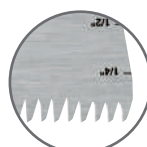

JAPANESE TOTHING
Reduced tooth height for longer lifetime

OMF229 STARLOCK

65mm Precision Cut Blade with Japanese Tothing for Wood. Long Life

FEATURES: Reinforced teeth with Bi-metal 8% Cobalt featuring double-row "Japanese Tothing". Guaranteed long life.

MATERIAL: For wood up to 50mm, plasterboard and soft plastics.

APPLICATION: Wide range of applications. Extra wide cutting edge for maximum cutting performance. For long, straight cuts.

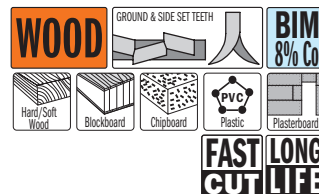

PACK Quantity	W mm	I mm	TS mm	TPI		ORDER NO. STARLOCK®
1 in clamshell	65	50	1,75	14	70	OMF229-X1
5 in clamshell	65	50	1,75	14	34	OMF229-X5
50 in masterpack	65	50	1,75	14	8	OMF229-X50



JAPANESE TOTHING
Reduced tooth height for longer lifetime

OMF208 STARLOCK PLUS

65mm Precision Cut Blade with Japanese Tothing for Wood. Long Life

FEATURES: Reinforced teeth with Bi-metal 8% Cobalt featuring double-row "Japanese Tothing". Guaranteed long life.

MATERIAL: For wood up to 50mm, plasterboard and soft plastics.

APPLICATION: Wide range of applications. Extra wide cutting edge for maximum cutting performance. For long, straight cuts.

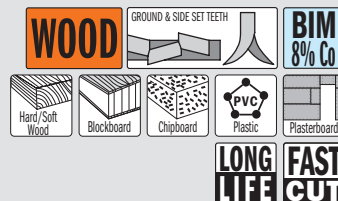

PACK Quantity	W mm	I mm	TS mm	TPI		ORDER NO. STARLOCKPLUS®
1 in clamshell	65	50	1,75	14	70	OMF208-X1
5 in clamshell	65	50	1,75	14	34	OMF208-X5
50 in masterpack	65	50	1,75	14	8	OMF208-X50

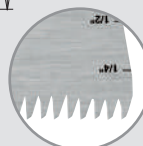

JAPANESE TOTHING
Reduced tooth height for longer lifetime

OMF184 STARLOCK

10mm Plunge Cut Blade for Wood & Nails. Long Life

FEATURES: Reinforced teeth with Bi-metal 8% Cobalt. Long life.

MATERIAL: For wood and wood with embedded nails up to 5mm, porous cement, plasterboard, and plastics.

APPLICATION: Extremely robust. Short and narrow shape ideal for tight groove work.

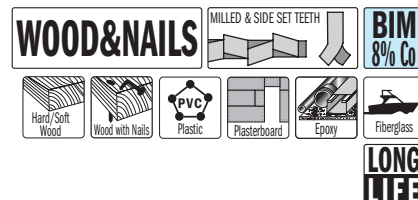

PACK Quantity	W mm	I mm	TS mm	TPI		ORDER NO. STARLOCK®
1 in clamshell	10	30	1,4	18	70	OMF184-X1
5 in clamshell	10	30	1,4	18	34	OMF184-X5
50 in masterpack	10	30	1,4	18	8	OMF184-X50

OMF183 STARLOCK



20mm Plunge Cut Blade for Wood & Nails. Long Life

FEATURES: Reinforced teeth with Bi-metal 8% Cobalt. Long life.

MATERIAL: For wood and wood with embedded nails up to 5mm, porous cement, plasterboard and plastics.

APPLICATION: Extremely robust. Short and narrow shape ideal for tight groove work.

WOOD&NAILS

MILLED & SIDE SET TEETH

BIM
8% Co

Hard/Soft Wood

Wood with Nails

PVC

Plasterboard

Epoxy

Fiberglass

LONG LIFE

PACK Quantity	W mm	I mm	TS mm	TPI		ORDER NO. STARLOCK®
1 in clamshell	20	34	1,4	18	70	OMF183-X1
5 in clamshell	20	34	1,4	18	34	OMF183-X5
50 in masterpack	20	34	1,4	18	8	OMF183-X50

OMF222 STARLOCK



28mm Plunge Cut Blade for Wood & Metal. Long Life

FEATURES: Reinforced teeth with Bi-metal 8% Cobalt for long life. Milled & wavy universal tothing.

MATERIAL: For sheet metal up to 2mm, wood products, plasterboard and soft plastics, non-ferrous pipe and profiles such as copper, aluminum and brass.

APPLICATION: Wide range of applications. Narrow waist means outstanding cutting speed and excellent swarf evacuation.

WOOD&METAL

MILLED & WAVY SET TEETH

BIM
8% Co

Hard/Soft Wood

Wood with Nails

PVC

Aluminium

Sheet Metal

Non Ferrous Metals

Plasterboard

Cu Zn
Non-Ferrous Metals

130%
LONGER LIFE

LONG LIFE

PACK Quantity	W mm	I mm	TS mm	TPI		ORDER NO. STARLOCK®
1 in clamshell	28	55	1,4	18	70	OMF222-X1
5 in clamshell	28	55	1,4	18	34	OMF222-X5
50 in masterpack	28	55	1,4	18	8	OMF222-X50

WAVY UNIVERSAL TOOTHING

OMF160 STARLOCK



35mm Plunge Cut Blade for Wood & Nails. Long Life

FEATURES: Reinforced teeth with Bi-metal 8% Cobalt. Long life.

MATERIAL: For wood and wood with embedded nails up to 5mm, porous cement, plasterboard, and plastics.

APPLICATION: Wide range of applications. Medium width waisted shape for optimum cutting quality and speed. Good swarf removal.

WOOD&NAILS

MILLED & SIDE SET TEETH

BIM
8% Co

Hard/Soft Wood

Wood with Nails

PVC

Plasterboard

Epoxy

Fiberglass

LONG LIFE

PACK Quantity	W mm	I mm	TS mm	TPI		ORDER NO. STARLOCK®
1 in clamshell	35	50	1,4	18	70	OMF160-X1
5 in clamshell	35	50	1,4	18	34	OMF160-X5
50 in masterpack	35	50	1,4	18	8	OMF160-X50



Watch the video on



OMF223 STARLOCK

44mm Plunge Cut Blade for Wood & Metal. Long Life

FEATURES: Reinforced teeth with Bi-metal 8% Cobalt for long life. Milled & wavy universal toothing.

MATERIAL: For sheet metal up to 2mm, wood products, plasterboard, and soft plastics, non-ferrous pipe and profiles such as copper, aluminum and brass.

APPLICATION: Wide range of applications. Narrow waist means outstanding cutting speed and good swarf evacuation.

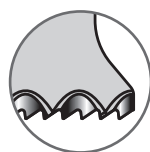
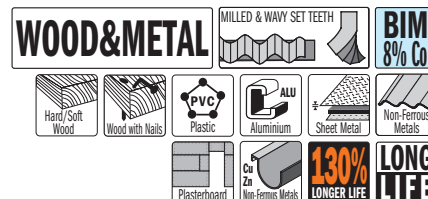

WAVY UNIVERSAL TOOthing

Pack Quantity	W mm	I mm	TS mm	TPI		ORDER NO. STARLOCK®
1 in clamshell	44	55	1,4	18	70	OMF223-X1
5 in clamshell	44	55	1,4	18	34	OMF223-X5
50 in masterpack	44	55	1,4	18	8	OMF223-X50

OMF221 STARLOCK

50mm Plunge Cut Blade for Wood & Nails. Long Life

FEATURES: Reinforced teeth with Bi-metal 8% Cobalt. Long life.

MATERIAL: For wood and wood with embedded nails up to 5mm, porous cement, plasterboard, and plastic.

APPLICATION: Wide range of applications. Wide waisted shape for maximum cutting performance and speed. Long straight cuts.

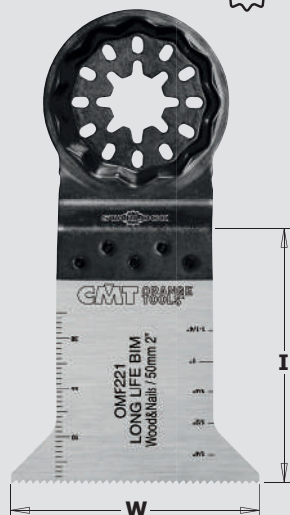
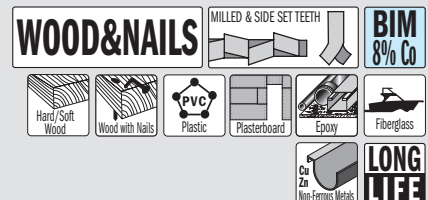

Pack Quantity	W mm	I mm	TS mm	TPI		ORDER NO. STARLOCK®
1 in clamshell	50	50	1,4	18	70	OMF221-X1
5 in clamshell	50	50	1,4	18	34	OMF221-X5
50 in masterpack	50	50	1,4	18	8	OMF221-X50

OMF228 STARLOCK

65mm Plunge Cut Blade for Wood & Nails. Long Life

FEATURES: Reinforced teeth with Bi-metal 8% Cobalt. Long life.

MATERIAL: For wood and wood with embedded nails up to 5mm, masonry, plasterboard and plastic.

APPLICATION: Plunge cut at any point in the material. Excellent cutting quality and speed. Wide shape for long straight cuts.

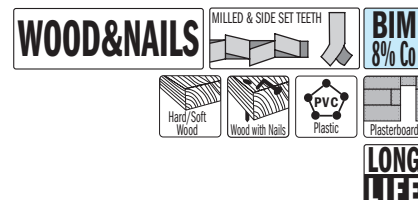

Pack Quantity	W mm	I mm	TS mm	TPI		ORDER NO. STARLOCK®
1 in clamshell	65	50	1,4	18	70	OMF228-X1
5 in clamshell	65	50	1,4	18	34	OMF228-X5
50 in masterpack	65	50	1,4	18	8	OMF228-X50

OMF161 STARLOCK PLUS new

65mm Plunge Cut Blade for Wood & Nails. Long Life

FEATURES: Reinforced teeth with Bi-metal 8% Cobalt. Long life.

MATERIAL: For wood and wood with embedded nails up to 5mm, masonry, plasterboard and plastic.

APPLICATION: Plunge cut at any point in the material. Excellent cutting quality and speed. Wide shape for long straight cuts.

WOOD&NAILS

MILLED & SIDE SET TEETH

BIM 8% Co

Hard/Soft Wood

Wood with Nails

PVC Plastic

Plasterboard

LONG LIFE



PACK Quantity	W mm	I mm	TS mm	TPI		ORDER NO. STARLOCKPLUS®
1 in clamshell	65	50	1,4	18	70	OMF161-X1
5 in clamshell	65	50	1,4	18	34	OMF161-X5
50 in masterpack	65	50	1,4	18	8	OMF161-X50

OMF157 STARLOCK new

30mm Plunge Cut Blade for Metal. Fine Cut

FEATURES: Reinforced teeth with Bi-metal 8% Cobalt for long life. Thin kerf.

MATERIAL: For sheet metal up to 2mm, hard plastics, non-ferrous pipe and profiles such as copper, aluminum and brass, and fiberglass.

APPLICATION: For particularly fine, thin and precise cuts. Easy control. Medium waist for faster cutting and good swarf evacuation.

METAL

MILLED & WAVY SET TEETH

BIM 8% Co

Sheet Metal

ALU Aluminum

PVC Plastic

Pipes, Profiles

Epoxy

Fiberglass

Cu Zn Non-Ferrous Metals

FINE CUT



PACK Quantity	W mm	I mm	TS mm	TPI		ORDER NO. STARLOCK®
1 in clamshell	30	50	1,2	21	70	OMF157-X1
5 in clamshell	30	50	1,2	21	34	OMF157-X5
50 in masterpack	30	50	1,2	21	8	OMF157-X50

OMF237 STARLOCK PLUS new

32mm Carbide + TiN Coating Plunge & Flush-Cut for Metal. Extra Long Life

FEATURES: Carbide teeth with TiN coating for Extra Long life.

MATERIAL: For metal up to 40-50 HRC in hardness, plasterboard, hard plastics, fiberglass (GRP) and wood with nails.

APPLICATION: Precise and easy to control. Very thin cuts. Narrow waist for fast cuts and good chip removal.

METAL

MILLED & WAVY SET TEETH

CARBIDE TiN

Metal 40-50 HRC

Plasterboard

PVC Plastic

Fiberglass

Wood with Nails

30X LONGER LIFE

EXTRA LONG LIFE

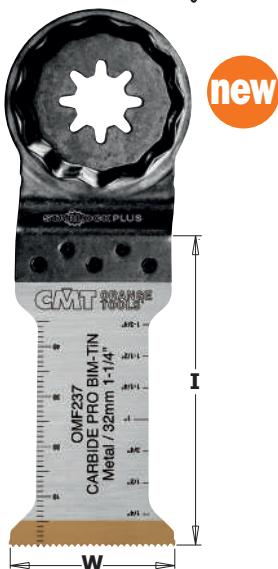

PACK Quantity	W mm	I mm	TS mm	TPI		ORDER NO. STARLOCKPLUS®
1 in clamshell	32	60	1,2	21	70	OMF237-X1

OMF118 STARLOCK

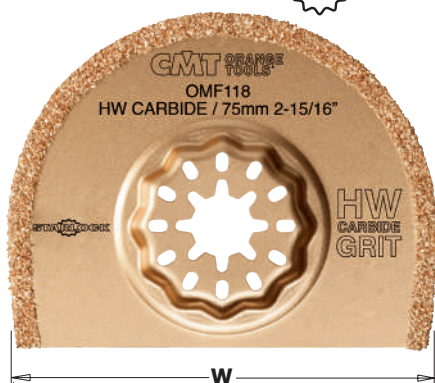

75mm Carbide Grit Radial Saw Blade, Segmented.

FEATURES: Carbide Grit.
MATERIAL: Segmented blade for tile joints, plasterboard, porous concrete, construction materials and cleaning teak seams on boat decks.

APPLICATION: An economical alternative to diamond tools. For cleaning very hard epoxy resin or cement jointwork, cutting out grout on walls or seams in flooring panels, grooving in porous concrete, laying concealed cables or pipes. Ideal for working close to corners and edges. Cutting edge width approx. 2,2mm.

MASONRY CARBIDE GRIT

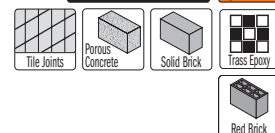

Pack Quantity	W mm	K mm		ORDER NO. STARLOCK®
1 in clamshell	75	2,2	80	OMF118-X1
5 in clamshell	75	2,2	40	OMF118-X5

OMF125 STARLOCK



75mm Carbide Grit Radial Saw Blade, Segmented

FEATURES: Carbide Grit.
MATERIAL: Segmented blade for tile joints, plasterboard, porous concrete, construction materials and cleaning teak seams on boat decks.

APPLICATION: An economical alternative to diamond tools. For cleaning very hard epoxy resin or cement jointwork, cutting out grout on tiled walls or seams in flooring panels, grooving in porous concrete, laying concealed cables or pipes. Ideal for working close to corners and edges. Extra-thin cutting edge width 1,2mm.

MASONRY CARBIDE GRIT

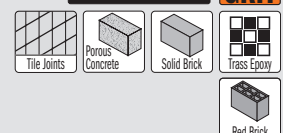

Pack Quantity	W mm	K mm		ORDER NO. STARLOCK®
1 in clamshell	75	1,2	100	OMF125-X1
5 in clamshell	75	1,2	40	OMF125-X5

OMF114 STARLOCK



75mm Diamond Coated Radial Saw Blade, Segmented. Extra-Long Life

FEATURES: Segmented radial saw blade with diamond grit for extra-long lifetime.
MATERIAL: Segmented blade for tiles, plasterboard, porous concrete, construction materials and cleaning teak seams on boat decks.

APPLICATION: For frequent use and challenging jobs, cleaning very hard epoxy resin or cement jointwork, cutting out grout on tiled walls or seams in flooring panels, grooving in porous concrete, laying concealed cables or pipes. Ideal for working close to corners and edges. Cutting edge width approx. 2,2mm.

MASONRY GRIT

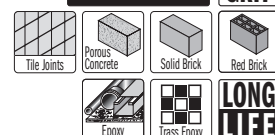

Pack Quantity	W mm	K mm		ORDER NO. STARLOCK®
1 in clamshell	75	2,2	115	OMF114-X1
5 in clamshell	75	2,2	56	OMF114-X5

OMF002 STARLOCK PLUS



45mm Carbide Grit Fingertip Rasp -Double-Sided

- FEATURES:** Carbide Grit on both sides.
- MATERIAL:** Abrasive rasp for tiles, plasterboard, porous concrete, stone, construction materials, wood and carpet adhesives.
- APPLICATION:** Wide variety of applications. Fingertip shape perfect for coarse grinding in tight corners, removal of cement, mortar and adhesive residues, scraping wood, and grinding tile adhesives, cement, stone, wood, fiberglass and plastic.

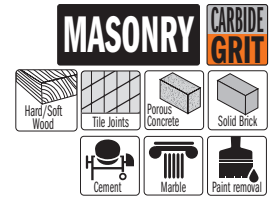

PACK Quantity	W mm	I mm		ORDER NO. STARLOCKPLUS®
1 in clamshell	33	45	250	OMF002-X1

OMF001 STARLOCK

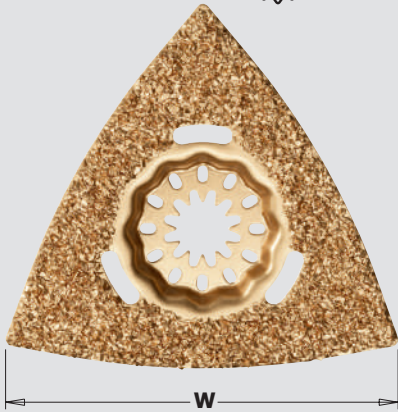

80mm Carbide Grit Delta Rasp

- FEATURES:** Carbide Grit.
- MATERIAL:** Triangular abrasive rasp for coarse grinding of tile adhesives, plasterboard, porous concrete, construction materials, wood and carpeting.
- APPLICATION:** Wide range of applications: For coarse grinding in tight corners, removal of cement, mortar and adhesive residues, scraping wood, and grinding tile adhesives, cement, stone, wood, fiberglass and plastic.

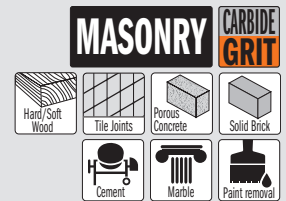

PACK Quantity	W mm		ORDER NO. STARLOCK®
1 in clamshell	80	250	OMF001-X1

OMF243 STARLOCK MAX



60mm Diamond Coated Saw Blade, Segmented. Extra-Long Life

- FEATURES:** Diamond coated for extra-long life. Segmented.
- MATERIAL:** For tiles, marble, hard epoxy resins and cement grouts.
- APPLICATION:** Best for frequent use and challenging jobs in tight corners and edges. Efficient shape allows aggressive grinding/scraping without damaging tile. Cuts out marble and Trass concrete joints, great for sinking ducts in plaster, pumice, brick and honeycomb stone as well as autoclave aerated concrete. Cutting width approx. 2.2mm

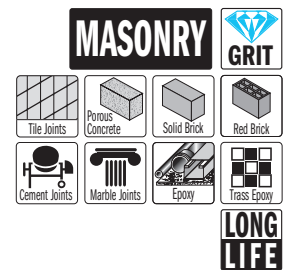

PACK Quantity	W mm	K mm		ORDER NO. STARLOCKMAX®
1 in clamshell	60	2,2	115	OMF243-X1

OMF226 STARLOCK



52mm Rigid Scraper Blade for All Materials

FEATURES: Rigid Scraper in HL steel.

APPLICATION: Removes old plant layers, adhesive, carpeting, tile and mortar residues as well as rubberized protectants.

MULTI-MAT

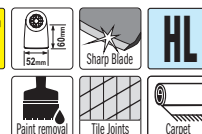

Pack Quantity	W mm	K mm		ORDER NO. STARLOCK®
1 in clamshell	52	0,8	100	OMF226-X1

OMF165 STARLOCK



52mm Flexible Scraper Blade for All Materials

FEATURES: Scraper in HL, flexible.

APPLICATION: Removes old layers of paint, adhesive, and carpeting residues as well as silicone joints.

MULTI-MAT

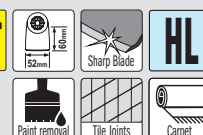

Pack Quantity	W mm	K mm		ORDER NO. STARLOCK®
1 in clamshell	52	0,4	100	OMF165-X1

OMF245 STARLOCK



70mm "Mushroom-Shaped" Cutting Blade for All Materials

FEATURES: HL steel blade with special mushroom shape.

APPLICATION: Best for frequent use and challenging jobs in tight corners and edges. Efficient shape allows aggressive grinding/scraping without damaging tile. Cuts out marble and Trass concrete joints, great for sinking ducts in plaster, pumice, brick and honeycomb stone as well as autoclave aerated concrete. Cutting width approx. 2.2mm. Blade shape keeps hands safely away from broken glass when repairing window panes and/or separating insulated glass panels.

MULTI-MAT



Pack Quantity	W mm	K mm		ORDER NO. STARLOCK®
5 in clamshell	70	0,4	50	OMF245-X5

OMF201 STARLOCK PLUS



4mm Angled Gouging Blade

FEATURES: Angled Gouging blade in HCS.
MATERIAL: For cutting, gouging and digging out soft materials like sealant, caulk and silicone from tight recesses.
APPLICATION: For cleaning out tight notches and narrow recesses or crevices. Specialized blade for boat maintenance such as reworking cabins, rails, gunwales, cleats and curves. Ideal for cutting out sealant on boats with panelled decks.



Pack Quantity	K mm	W mm	I mm		ORDER NO. STARLOCKPLUS®
1 in clamshell	4	16	11	70	OMF201-X1

OMF251 STARLOCK

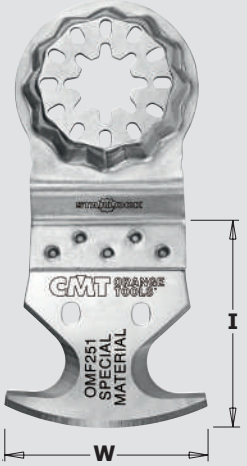

41mm Multi-Knife with Three Cutting Edges, Segmented

FEATURES: Segmented multi-knife with three cutting edges.
MATERIAL: For removing carpeting residues, soft materials like sealant and foam insulation, leather goods, PVC flooring, cardboard, bitumen shingles and roofing paper.
APPLICATION: Unique shape means that material can be cut simply by pulling, pushing or pressing. Ideal for grout between tiles and removing carpet, PVC floors, cardboard, bitumen shingles and roofing fabric.



Pack Quantity	W mm	I mm		ORDER NO. STARLOCK®
1 in clamshell	41	41	70	OMF251-X1

OMF-X4 STARLOCK



4 piece General Purpose Set for Multi-Cutters

- 2 blades with Japanese Tothing for all wood products, blockboard, plasterboard and plastics.
- 2 blades in BIM for all wood products, blockboard, plasterboard, fiberglass, epoxy resin and soft plastics. Excellent for cutting wood with embedded nails up to 5mm in diameter and even masonry, like porous concrete.

WOOD WOOD&NAILS

8 Sets in End-cap display (minimum order 8 sets)



Pack Quantity	MATERIAL	W mm	I mm	TS mm	TPI	ORDER NO.
1	HCS	35	50	1,75	14	OMF126-X1
1	BIM	35	50	1,4	18	OMF160-X1
1	BIM	50	50	1,4	18	OMF221-X1
1	HCS	65	50	1,75	14	OMF230-X1

OMF136 STARLOCK

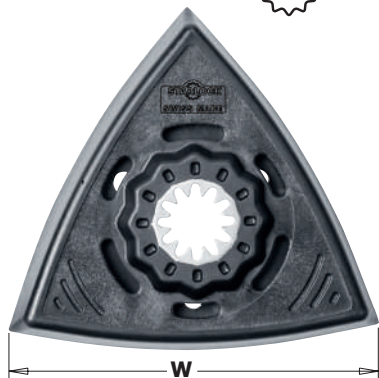

93mm Delta Sanding Pad. Perforated

FEATURES: Triangular perforated sanding pad with micro VELCRO®. Quick, easy sanding sheet changes.

APPLICATION: Perfectly sands surfaces on any material. Comprehensive range of sanding sheets permits a wide range of sanding applications.



Pack Quantity	W mm		ORDER NO. STARLOCK®
1 in clamshell	93	40	OMF136-X1

OMA30000



93mm Delta Polishing Fleece. Perforated

FEATURES: Triangular polishing fleece with micro VELCRO®. For use with skus #OMM30, #OMS30 and #OMF136.

APPLICATION: Suitable for bringing out grain in wood (rustic look), de-rusting metal, matte sanding varnished surfaces and glass, removing dirt and deposits without altering the workpiece surface.

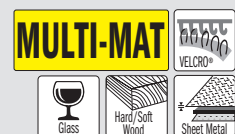

Pack Quantity	W mm		ORDER NO.
4 in clamshell	93	10	OMA30000-X4

OMA30



93mm Aluminium-Oxide Delta Sandpaper for Wood. Perforated

FEATURES: Triangular sandpaper sheet with micro VELCRO®. For use with skus #OMM30 and #OMS30 and #OMF136.

APPLICATION: Suitable for sanding all types of wood, chipboard, plywood, construction boards, for pre-sanding of rough, uneven beams, boards and panels. Best results achieved with dust extractor. Aluminium-Oxide abrasive grain and full resin bond guarantee high abrasion performance.

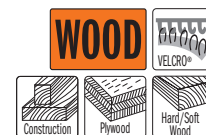

Pack Quantity	W mm	GRIT		ORDER NO.
10 in clamshell	93	40	10	OMA30040-X10
10 in clamshell	93	60	10	OMA30060-X10
10 in clamshell	93	80	10	OMA30080-X10
10 in clamshell	93	100	10	OMA30100-X10
10 in clamshell	93	120	10	OMA30120-X10
10 in clamshell	93	180	10	OMA30180-X10
10 in clamshell	93	240	10	OMA30240-X10

THE RIGHT BLADE FOR THE BEST RESULTS!

Quick reference charts and pictograms help you choose the right blade for your application.

WOOD



WOOD&METAL



MULTI-MAT



MASONRY



CMT UNIVERSAL ARBOR FITS MOST MULTI-CUTTERS ON THE MARKET

This tool mount also enables the accessory to be repositioned in 30-degree steps.

ARBOR FOR FEIN® SUPERCUT AND FESTOOL® VECTURO®

This tool mount also enables the accessory to be repositioned in 30-degree steps.

OMA31

Universal Adapters

This universal adapter permits easy attachment of CMT accessories to most multi-cutter tools. Fits snugly and does not slip. Ideal for BOSCH®, CHICAGO®, CRAFTSMAN®, DREMEL®, FEIN®, MAKITA®, MILWAUKEE®, MASTERCRAFT®, OZITO®, AEG®, RIDGID®, ROCKWELL®, SMART®, WORX®.



Pack Quantity	ORDER NO.
2 in clamshell	OMA31-X2

OMM01 OMS01

Universal Arbor



Arbor for
FEIN® SuperCut
FESTOOL® VECTURO®



10mm Plunge and Flush-Cut Blade for Wood

FEATURES: HCS with hardened teeth.

MATERIAL: For wood, blockboard, chipboard, plastic, pipes and profiles.

APPLICATION: Wide range of applications: installing a ventilation grille, cutting a recess in furniture elements to enable access to a mains socket, adjustment work in wood like sawing recesses for locks and fitting, window and door hardware.

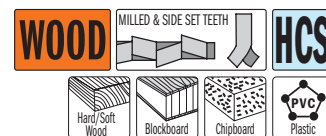

PACK Quantity	W mm	I mm	TPI		ORDER NO. Universal Arbor	ORDER NO. Arbor for FEIN® Supercut
1 in clamshell	10	28	18	10	OMM01-X1	OMS01-X1

OMM02 OMS02

Universal Arbor

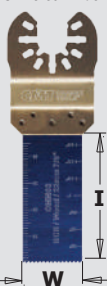

Arbor for
FEIN® SuperCut
FESTOOL® VECTURO®



22mm Plunge and Flush-Cut Blade for Wood

FEATURES: HCS with hardened teeth.

MATERIAL: For wood, blockboard, chipboard, plastic, pipes and profiles.

APPLICATION: Wide range of applications: installing a ventilation grille, cutting a recess in furniture elements to enable access to a mains socket, flush-cutting wooden components to length (like dowels and tenons), window and door hardware.

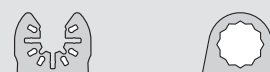
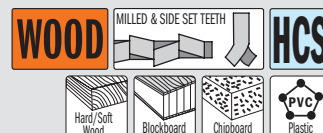

PACK Quantity	W mm	I mm	TPI		ORDER NO. Universal Arbor	ORDER NO. Arbor for FEIN® Supercut
1 in clamshell	22	48	18	10	OMM02-X1	OMS02-X1
5 in clamshell	22	48	18	5	OMM02-X5	OMS02-X5

OMM03 OMS03

Universal Arbor



Arbor for
FEIN® SuperCut
FESTOOL® VECTURO®



28mm Plunge and Flush-Cut Blade for Wood

FEATURES: HCS with hardened teeth.

MATERIAL: For wood, blockboard, chipboard, plastic, pipes and profiles.

APPLICATION: Wide range of applications: installing a ventilation grille, cutting a recess in furniture elements to enable access to a mains socket, flush-cutting wooden components to length (like dowels and tenons), window and door hardware.

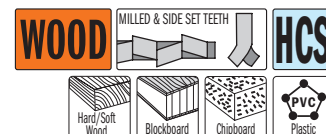

PACK Quantity	W mm	I mm	TPI		ORDER NO. Universal Arbor	ORDER NO. Arbor for FEIN® Supercut
1 in clamshell	28	48	18	10	OMM03-X1	OMS03-X1
50 in masterpack	28	48	18	2	OMM03-X50	OMS03-X50

OMM04 OMS04

Universal Arbor



Arbor for
FEIN® SuperCut
FESTOOL® VECTURO®



34mm Precision Cut Blade - Japanese Tothing for Wood

FEATURES: HCS with "Japanese" double-row pattern, hardened teeth.

MATERIAL: For wood, timber, blockboard, chipboard.

APPLICATION: Ground and side set teeth for precision, clean, quick cutting into soft wood and timber. This tooth pattern with its longer teeth allows you to start cutting from a precise point by standing the blade on its corner and lowering it into the wood.

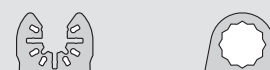
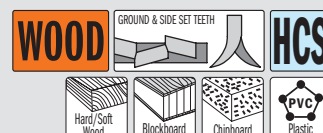

PACK Quantity	W mm	I mm	TPI		ORDER NO. Universal Arbor	ORDER NO. Arbor for FEIN® Supercut
1 in clamshell	34	40	14	10	OMM04-X1	OMS04-X1
5 in clamshell	34	40	14	5	OMM04-X5	OMS04-X5
50 in masterpack	34	40	14	2	OMM04-X50	OMS04-X50



OMM05

Universal Arbor

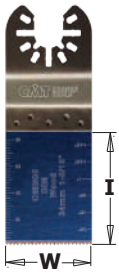

OMS05

Arbor for FEIN® SuperCut FESTOOL® VECTURO®



34mm Plunge and Flush-Cut Blade for Wood. Extra-Long Life

FEATURES: Bi-metal with 8% Cobalt teeth guarantee extra-long life.

MATERIAL: For wood, blockboard, chipboard, plastic, pipes and profiles.

APPLICATION: Wide range of applications: installing a ventilation grille, cutting a recess in furniture elements to enable access to a mains socket, flush-cutting wooden components to length (like dowels and tenons), window and door hardware.

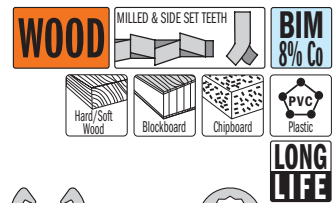

PACK Quantity	W mm	I mm	TPI		ORDER NO. Universal Arbor	ORDER NO. Arbor for FEIN® Supercut
1 in clamshell	34	40	18	10	OMM05-X1	OMS05-X1
5 in clamshell	34	40	18	5	OMM05-X5	OMS05-X5
50 in masterpack	34	40	18	2	OMM05-X50	OMS05-X50

OMM36

Universal Arbor

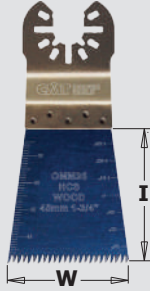

OMS36

Arbor for FEIN® SuperCut FESTOOL® VECTURO®



45mm Precision Cut Blade -Japanese Toothing for Wood

FEATURES: HCS with "Japanese" double-row pattern, hardened teeth.

MATERIAL: For wood, timber, blockboard, chipboard.

APPLICATION: Ground and side-set teeth for precision, clean, quick cutting into soft wood and timber. This tooth pattern with its longer teeth allows you to start cutting from a precise point by standing the blade on its corner and lowering it into the wood. Ideal width for creating long flat horizontal cuts like: door jambs and skirting board.

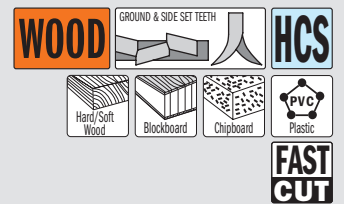

PACK Quantity	W mm	I mm	TPI		ORDER NO. Universal Arbor	ORDER NO. Arbor for FEIN® Supercut
5 in clamshell	45	50	14	5	OMM36-X5	OMS36-X5
50 in masterpack	45	50	14	2	OMM36-X50	OMS36-X50

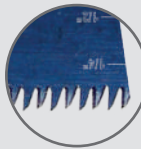

Japanese tothing

OMM06

Universal Arbor



OMS06

Arbor for FEIN® SuperCut FESTOOL® VECTURO®



68mm Precision Cut Blade -Japanese Toothing for Wood

FEATURES: HCS with "Japanese" double-row pattern, hardened teeth.

MATERIAL: For wood, timber, blockboard, chipboard.

APPLICATION: Ground and side-set teeth for precision, clean, quick cutting into soft wood and timber. This tooth pattern with its longer teeth allows you to start cutting from a precise point by standing the blade on its corner and lowering it into the wood. Ideal width for creating long flat horizontal cuts like: door jambs and skirting board.

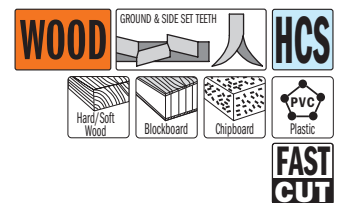

PACK Quantity	W mm	I mm	TPI		ORDER NO. Universal Arbor	ORDER NO. Arbor for FEIN® Supercut
1 in clamshell	68	40	14	10	OMM06-X1	OMS06-X1
5 in clamshell	68	40	14	5	OMM06-X5	OMS06-X5
50 in masterpack	68	40	14	2	OMM06-X50	OMS06-X50

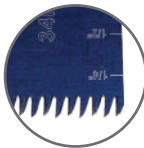

Japanese tothing

OMM07

Universal Arbor

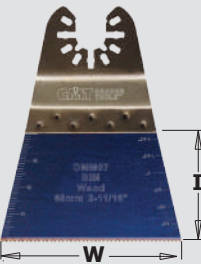

OMS07

Arbor for FEIN® SuperCut FESTOOL® VECTURO®



68mm Precision Cut Blade - Japanese Tothing for Wood

FEATURES: Bi-metal with 8% Cobalt teeth guarantee extra-long life.

MATERIAL: For wood, blockboard, chipboard, plastic, pipes and profiles.

APPLICATION: Wide range of applications: installing a ventilation grille, cutting a recess in furniture elements to enable access to a mains socket, flush-cutting wooden components to length (like dowels and tenons), window and door hardware.

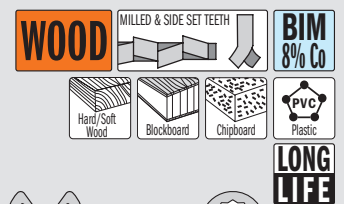

PACK Quantity	W mm	I mm	TPI		ORDER NO. Universal Arbor	ORDER NO. Arbor for FEIN® Supercut
1 in clamshell	68	40	18	10	OMM07-X1	OMS07-X1
5 in clamshell	68	40	18	5	OMM07-X5	OMS07-X5
50 in masterpack	68	40	18	2	OMM07-X50	OMS07-X50

Accessories for Multi-Cutters

OMM08

Universal Arbor

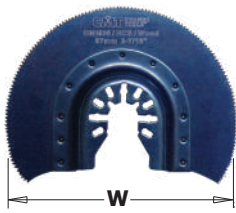

OMS08

Arbor for FEIN® SuperCut FESTOOL® VECTURO®

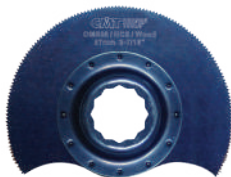

87mm Radial Saw Blade for Wood, Segmented

FEATURES: HCS with hardened teeth.
MATERIAL: For wood, blockboard, chipboard, plastic, pipes and profiles.
APPLICATION: Wide range of applications: installing a ventilation grille, cutting a recess in furniture elements to enable access to a mains socket, flush-cutting wooden components to length (like dowels and tenons). Cutting a plastic pipe (PVC) to length.

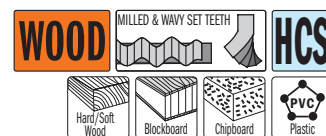

PACK Quantity	W mm	TPI		ORDER NO. Universal Arbor	ORDER NO. Arbor for FEIN® SuperCut
1 in clamshell	87	18	10	OMM08-X1	OMS08-X1

OMM09

Universal Arbor



OMS09

Arbor for FEIN® SuperCut FESTOOL® VECTURO®



10mm Plunge and Flush-Cut Blade for Wood & Metal

FEATURES: Bi-metal with 8% Cobalt teeth.
MATERIAL: For wood, chipboard, plastic, sheet metal, copper and aluminium pipes and profiles.
APPLICATION: Wide range of applications: flush-cutting a nail in wood, adjustment work on non-ferrous profiles, plunge-cutting in plasterboard.



PACK Quantity	W mm	I mm	TPI		ORDER NO. Universal Arbor	ORDER NO. Arbor for FEIN® SuperCut
1 in clamshell	10	28	18	10	OMM09-X1	OMS09-X1
5 in clamshell	10	28	18	5	OMM09-X5	OMS09-X5
50 in masterpack	10	28	18	2	OMM09-X50	OMS09-X50

OMM10

Universal Arbor

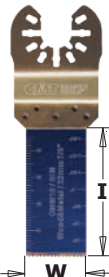

OMS10

Arbor for FEIN® SuperCut FESTOOL® VECTURO®



22mm Plunge and Flush-Cut for Wood & Metal

FEATURES: Bi-metal with 8% Cobalt teeth.
MATERIAL: For wood, plasterboard, plastic, sheet metal, copper and aluminium pipes and profiles.
APPLICATION: Wide range of applications: flush-cutting a nail in wood, cutting copper pipes, plunge-cutting in plasterboard.

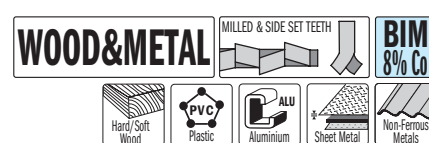

PACK Quantity	W mm	I mm	TPI		ORDER NO. Universal Arbor	ORDER NO. Arbor for FEIN® SuperCut
1 in clamshell	22	48	18	10	OMM10-X1	OMS10-X1
5 in clamshell	22	48	18	5	OMM10-X5	OMS10-X5
50 in masterpack	22	48	18	2	OMM10-X50	OMS10-X50

OMM11

Universal Arbor

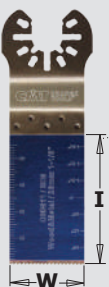

OMS11

Arbor for FEIN® SuperCut FESTOOL® VECTURO®



28mm Plunge and Flush-Cut Blade for Wood & Metal

FEATURES: Bi-metal with 8% Cobalt teeth.
MATERIAL: For wood, plasterboard, plastic, sheet metal, copper and aluminium pipes and profiles.
APPLICATION: Wide range of applications: flush-cutting a nail in wood, cutting copper pipes and aluminium profiles, plunge-cutting in plasterboard.



PACK Quantity	W mm	I mm	TPI		ORDER NO. Universal Arbor	ORDER NO. Arbor for FEIN® SuperCut
1 in clamshell	28	48	18	10	OMM11-X1	OMS11-X1
5 in clamshell	28	48	18	5	OMM11-X5	OMS11-X5
50 in masterpack	28	48	18	2	OMM11-X50	OMS11-X50

OMM12

Universal Arbor



OMS12

Arbor for FEIN® SuperCut FESTOOL® VECTURO®



OMS12
W=32mm

34mm Plunge and Flush-Cut for Wood & Metal

FEATURES: Bi-metal with 8% Cobalt teeth.

MATERIAL: For wood, plasterboard, plastic, sheet metal, copper and aluminium pipes and profiles.

APPLICATION: Wide range of applications: flush-cutting a nail in wood, cutting copper pipes and aluminium profiles, plunge-cutting in plasterboard.

WOOD&METAL **MILLED & SIDE SET TEETH** **BIM 8% Co**



Pack Quantity	W mm	I mm	TPI		ORDER NO. Universal Arbor	ORDER NO. Arbor for FEIN® Supercut
1 in clamshell	34	40	18	10	OMM12-X1	OMS12-X1
5 in clamshell	34	40	18	5	OMM12-X5	OMS12-X5
50 in masterpack	34	40	18	2	OMM12-X50	OMS12-X50

OMM13

Universal Arbor



OMS13

Arbor for FEIN® SuperCut FESTOOL® VECTURO®



OMS13
W=32mm

34mm Plunge & Flush-Cut Blade for Wood & Metal. Extra-Long Life

FEATURES: TiN Coated Bi-metal with 8% Cobalt.

MATERIAL: For wood and nails, plasterboard, plastic, sheet metal, copper and aluminium pipes and profiles.

APPLICATION: Wide range of applications: flush-cutting a nail in wood, cutting copper pipes and aluminium profiles, plunge-cutting in plasterboard. Tooth strip coated with titanium nitride for 130% longer life.

WOOD&METAL **MILLED & SIDE SET TEETH** **BIM TiN**

130% LONGER LIFE **LONG LIFE**



Pack Quantity	W mm	I mm	TPI		ORDER NO. Universal Arbor	ORDER NO. Arbor for FEIN® Supercut
1 in clamshell	34	40	18	10	OMM13-X1	OMS13-X1
5 in clamshell	34	40	18	5	OMM13-X5	OMS13-X5
50 in masterpack	34	40	18	2	OMM13-X50	OMS13-X50

OMM14

Universal Arbor



OMS14

Arbor for FEIN® SuperCut FESTOOL® VECTURO®



35mm Plunge & Flush-Cut Blade for Wood & Metal. Extra-Long Life

FEATURES: High quality carbide teeth.

MATERIAL: for wood, hardened screws and nails, plasterboard, plastic, sheet metal, copper, aluminium and stainless steel.

APPLICATION: wide range of applications: cutting hardened screws/nails, cutting stainless steel like kitchen cabinet fronts, plunge cuts in severely abrasive materials like fiberglass.

WOOD&METAL **HW**

2X LONGER LIFE **LONG LIFE**



Pack Quantity	W mm	I mm	TPI		ORDER NO. Universal Arbor	ORDER NO. Arbor for FEIN® Supercut
1 in clamshell	35	40	20	10	OMM14-X1	OMS14-X1

OMM35

Universal Arbor



OMS35

Arbor for FEIN® SuperCut FESTOOL® VECTURO®



EXTRA LONG

42mm Plunge and Flush-Cut Blade for Wood & Metal

FEATURES: Bi-metal with 8% Cobalt teeth.

MATERIAL: for wood, plasterboard, plastic, sheet metal, copper and aluminium pipes and profiles.

APPLICATION: flush-cutting a nail, cutting copper pipes and aluminium profiles, plunge-cutting in plasterboard.

WOOD&METAL **MILLED & SIDE SET TEETH** **BIM 8% Co**



Pack Quantity	W mm	I mm	TPI		ORDER NO. Universal Arbor	ORDER NO. Arbor for FEIN® Supercut
5 in clamshell	42	68	18	5	OMM35-X5	OMS35-X5
50 in masterpack	42	68	18	2	OMM35-X50	OMS35-X50

OMM15

Universal Arbor

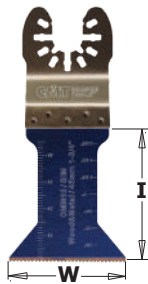

OMS15

Arbor for FEIN® SuperCut FESTOOL® VECTURO®



45mm Plunge and Flush-Cut Blade for Wood & Metal

FEATURES: Bi-metal with 8% Cobalt.
MATERIAL: For wood, plasterboard, plastic, sheet metal, copper and aluminium pipes and profiles.
APPLICATION: Wide range of applications: flush-cutting a nail, cutting copper pipes and aluminium profiles, plunge-cutting in plasterboard.

WOOD&METAL MILLED & SIDE SET TEETH **BIM 8% Co**

Hard/Soft Wood PVC Plastic ALU Aluminium Sheet Metal Non-Ferrous Metals

Pack Quantity	W mm	I mm	TPI		ORDER NO. Universal Arbor	ORDER NO. Arbor for FEIN® SuperCut
1 in clamshell	45	48	18	10	OMM15-X1	OMS15-X1
5 in clamshell	45	48	18	5	OMM15-X5	OMS15-X5
50 in masterpack	45	48	18	2	OMM15-X50	OMS15-X50

OMM16

Universal Arbor



OMS16

Arbor for FEIN® SuperCut FESTOOL® VECTURO®



45mm Plunge & Flush-Cut for Wood & Metal. Extra-Long Life

FEATURES: TiN coated Bi-metal with 8% Cobalt.
MATERIAL: For wood and nails, plasterboard, plastic, sheet metal, copper and aluminium pipes and profiles.
APPLICATION: Wide range of applications: flush-cutting a nail, cutting copper pipes and aluminium profiles, plunge-cutting in plasterboard. Coated with titanium nitride for 130% longer life.

WOOD&METAL MILLED & SIDE SET TEETH **BIM 8% Co**

Hard/Soft Wood PVC Plastic ALU Aluminium Sheet Metal Non-Ferrous Metals

130% LONGER LIFE **LONG LIFE**

Pack Quantity	W mm	I mm	TPI		ORDER NO. Universal Arbor	ORDER NO. Arbor for FEIN® SuperCut
1 in clamshell	45	48	18	10	OMM16-X1	OMS16-X1
5 in clamshell	45	48	18	5	OMM16-X5	OMS16-X5
50 in masterpack	45	48	18	2	OMM16-X50	OMS16-X50

OMM17

Universal Arbor

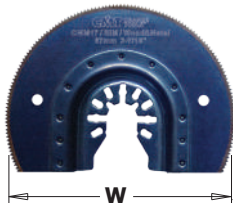

OMS17

Arbor for FEIN® SuperCut FESTOOL® VECTURO®



87mm Radial Saw Blade for Wood & Metal, Segmented.

FEATURES: Bi-metal with 8% Cobalt.
MATERIAL: For wood, veneered panels, plastic and laminated-panels, sheet metal, copper and aluminium pipes and profiles.
APPLICATION: Wide range of applications: cutting a nail to size, cutting a door frame and laminate/parquet, cutting aluminium profiles, plunge-cutting.

WOOD&METAL **BIM 8% Co**

Hard/Soft Wood PVC Plastic ALU Aluminium Sheet Metal Non-Ferrous Metals

LONG LIFE

Pack Quantity	W mm	TPI		ORDER NO. Universal Arbor	ORDER NO. Arbor for FEIN® SuperCut
1 in clamshell	87	20	10	OMM17-X1	OMS17-X1

OMM18

Universal Arbor

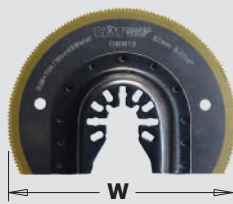

OMS18

Arbor for FEIN® SuperCut FESTOOL® VECTURO®



87mm Radial Saw Blade for Wood & Metal, Segmented. Extra-long life

FEATURES: TiN Coated Bi-metal with 8% Cobalt.
MATERIAL: For wood, plasterboard and fibercement boards, sheet metal, copper and aluminium pipes and profiles.
APPLICATION: Wide range of applications: plunge-cutting in plasterboard, custom moulding cutting, cutting recesses in epoxy/fibreglass like boat dashboards.

WOOD&METAL **BIM TiN**

Hard/Soft Wood PVC Plastic ALU Aluminium Sheet Metal Cu Zn Non-Ferrous Metals

130% LONGER LIFE **LONG LIFE**

Pack Quantity	W mm	TPI		ORDER NO. Universal Arbor	ORDER NO. Arbor for FEIN® SuperCut
1 in clamshell	87	20	10	OMM18-X1	OMS18-X1

OMM19

Universal Arbor



OMS19

Arbor for
FEIN® SuperCut
FESTOOL® VECTURO®



52mm Rigid Scraper for all Materials

FEATURES: HL rigid scraper.

APPLICATION: Wide range of applications: removing mortar or tile adhesive, removing mortar and concrete residues, removing hard, brittle carpet adhesive residues.

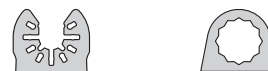

Pack Quantity	W mm	I mm		ORDER NO. Universal Arbor	ORDER NO. Arbor for FEIN® Supercut
1 in clamshell	52	26	10	OMM19-X1	OMS19-X1
5 in clamshell	52	26	5	OMM19-X5	OMS19-X5

OMM20

Universal Arbor



OMS20

Arbor for
FEIN® SuperCut
FESTOOL® VECTURO®



52mm Flexible Scraper for all Materials

FEATURES: HL flexible scraper.

APPLICATION: Wide range of applications: removing soft carpet adhesive residues, removing paint residues, removing silicone joints.

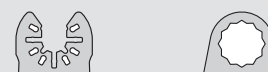

Pack Quantity	W mm	I mm		ORDER NO. Universal Arbor	ORDER NO. Arbor for FEIN® Supercut
1 in clamshell	52	45	10	OMM20-X1	OMS20-X1
5 in clamshell	52	45	5	OMM20-X5	OMS20-X5

OMM21

Universal Arbor



OMS21

Arbor for
FEIN® SuperCut
FESTOOL® VECTURO®



28mm Sharp Corner Scraper for all Materials

FEATURES: HL sharp corner scraper.

APPLICATION: Wide range of applications: cutting soft expansion joints, cutting window putty like sealing compound, cutting insulation materials.



Pack Quantity	W mm	I mm		ORDER NO. Universal Arbor	ORDER NO. Arbor for FEIN® Supercut
1 in clamshell	28	50	10	OMM21-X1	OMS21-X1
5 in clamshell	28	50	5	OMM21-X5	OMS21-X5
50 in masterpack	28	50	2	OMM21-X50	OMS21-X50

OMM22

Universal Arbor



OMS22

Arbor for
FEIN® SuperCut
FESTOOL® VECTURO®



87mm Carbide Grit Radial Saw Blade, Segmented.

FEATURES: Carbide Grit.

MATERIAL: Radial saw blade for tiles joints, plasterboard, porous concretes and similar construction materials.

APPLICATION: Wide range of applications: cutting wall or floor joints, small cutouts in soft/porous wall tiles, groove work in porous concrete, and laying concealed cables and pipes.

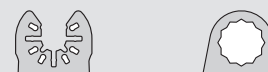
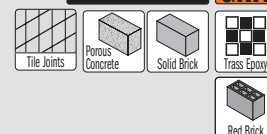

Pack Quantity	W mm	K mm		ORDER NO. Universal Arbor	ORDER NO. Arbor for FEIN® Supercut
1 in clamshell	87	2,2	10	OMM22-X1	OMS22-X1

OMM23

Universal Arbor

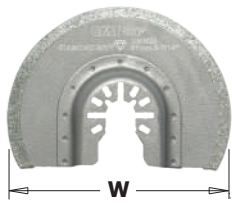

OMS23

Arbor for
FEIN® SuperCut
FESTOOL® VECTURO®



87mm Diamond Coated Radial Saw Blade, Segmented. Extra-Long Life

FEATURES: Diamond grit for extended lifetime.

MATERIAL: Segmented radial saw blade for tiles joints, plasterboard, porous concretes, construction materials, epoxy resin and fibreglass.

APPLICATION: Wide range of applications: cutting joints on wall and floor tiles, small cutouts in soft wall tiles, cutting recesses in epoxy resin/fibreglass and reinforced plastic used on boat hulls, and cutting bonding adhesives used on tiles.

MASONRY GRIT

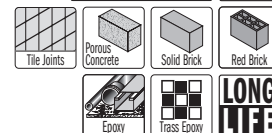

LONG LIFE



Pack Quantity	W mm	K mm		ORDER NO. Universal Arbor	ORDER NO. Arbor for FEIN® Supercut
1 in clamshell	87	1,6	10	OMM23-X1	OMS23-X1
25 in masterpack	87	1,6	2	OMM23-X25	OMS23-X25

OMM24

Universal Arbor

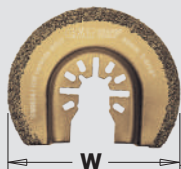

OMS24

Arbor for
FEIN® SuperCut
FESTOOL® VECTURO®



65mm Carbide Grit Radial Saw Blade, Segmented

FEATURES: Carbide Grit.

MATERIAL: Radial saw blade for tiles joints, plasterboard, porous concretes and similar construction materials.

APPLICATION: Wide range of applications: cutting joints on wall and floor tiles, small cutouts in soft wall tiles, groove work in porous concrete, and laying concealed cables and pipes.

MASONRY CARBIDE GRIT

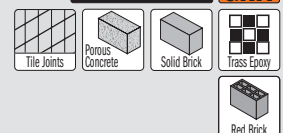

Pack Quantity	W mm	K mm		ORDER NO. Universal Arbor	ORDER NO. Arbor for FEIN® Supercut
1 in clamshell	65	1,6	10	OMM24-X1	OMS24-X1

OMM27

Universal Arbor



OMS27

Arbor for
FEIN® SuperCut
FESTOOL® VECTURO®



65mm Diamond Grit Coated Radial Saw Blade, Segmented. Extra-Long Life

FEATURES: Diamond grit for extended lifetime.

MATERIAL: Segmented radial saw blade for tiles joints, plasterboard, porous concretes, construction materials, epoxy resin and glass fibre.

APPLICATION: Wide range of applications: cutting joints on wall and floor tiles, small cutouts in soft wall tiles, recess work in epoxy resin/fibreglass and reinforced plastic used on boat hulls, cutting bonding adhesives used on tiles.

MASONRY GRIT

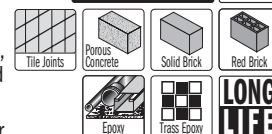

LONG LIFE



Pack Quantity	W mm	K mm		ORDER NO. Universal Arbor	ORDER NO. Arbor for FEIN® Supercut
1 in clamshell	65	2	10	OMM27-X1	OMS27-X1

OMM26

Universal Arbor



35mm Carbide Grit Fingertip Rasp - Double-Sided

FEATURES: Carbide Grit on both sides.

MATERIAL: Fingertip Rasp for tiles, plasterboard, porous concretes, construction materials, wood, carpets.

APPLICATION: Wide range of applications: removing mortar or tile adhesive, removing carpet adhesive residues, rasping wood for rough adjustments, rough grinding of filler, tile adhesives, concrete, stone and wood.

MASONRY CARBIDE GRIT

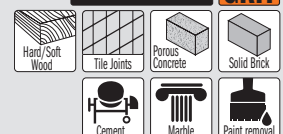

Pack Quantity	W mm	I mm		ORDER NO. Universal Arbor
1 in clamshell	33	35	10	OMM26-X1

OMM25

Universal Arbor

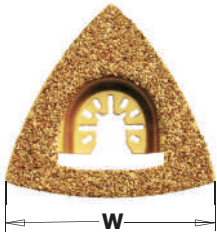

80mm Carbide Grit Delta Rasp

FEATURES: Carbide Grit.

MATERIAL: Abrasive triangular rasp for tiles, plasterboard, porous concretes, construction materials, wood, carpets.

APPLICATION: Wide range of applications: removing mortar or tile adhesive, removing carpet adhesive residues, rasping wood for rough adjustment, rough grinding of filler, tile adhesives, concrete, stone and wood.



Pack Quantity	W mm		ORDER NO. Universal Arbor
1 in clamshell	80	10	OMM25-X1

OMM28

Universal Arbor



57mm Diamond Coated Segment Saw Blade. Extra-Long Life

FEATURES: Diamond grit for extended lifetime.

MATERIAL: Segmented blade for tiles, marble, epoxy resins.

APPLICATION: Wide range of applications: removes mortar from tiled surfaces. Efficient shape allows for aggressive grinding without damaging tiles. For cutting out marble, epoxy resin and Trass joint work, cutting in plaster, brick, pumice and honeycomb stone as well as autoclave aerated concrete. Long-lasting blades designed specifically for very hard mortar.

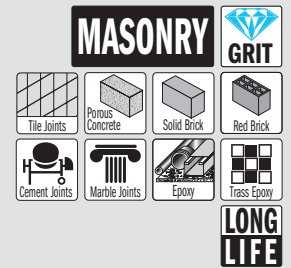

Pack Quantity	W mm	K mm		ORDER NO. Universal Arbor
1 in clamshell	57	2	10	OMM28-X1
25 in masterpack	57	2	4	OMM28-X25

OMM29

Universal Arbor



OMS29

Arbor for FEIN® SuperCut FESTOOL® VECTURO®



65mm Carbide Grit Grout and Mortar Remover

FEATURES: Carbide Grit.

MATERIAL: Grout and mortar remover for tiles, concrete, stone.

APPLICATION: Wide range of applications: grout removal, rasping away mortar or tile adhesive, remove joints, tiles, all with one tool. Suitable for removing carpet residues from mineral surfaces. The special design allows precision work into 90° corners.

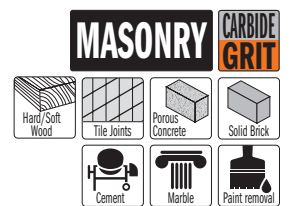

Pack Quantity	W mm		ORDER NO. Universal Arbor	ORDER NO. Arbor for FEIN® Supercut
1 in clamshell	65	10	OMM29-X1	OMS29-X1

OMM30

Universal Arbor



OMS30

Arbor for FEIN® SuperCut FESTOOL® VECTURO®



93mm Delta Sanding Pad, Perforated

FEATURES: Perforated sanding pad with self adhesive VELCRO®.

APPLICATION: Quick and easy sanding sheet changes. Comprehensive range of sanding sheets allows for perfect sanding of any material or surface.



Pack Quantity	W mm		ORDER NO. Universal Arbor	ORDER NO. Arbor for FEIN® Supercut
1 in clamshell	93	10	OMM30-X1	OMS30-X1

93mm Delta Polishing Fleece. Perforated



OMA30000

SEE PAGE 110



OMA30

93mm Aluminium-Oxide Delta Sandpaper for Wood. Perforated

Accessories for Multi-Cutters

OMM-X4

Universal Arbor



4 piece General Purpose Set for Multi-Cutters

- 2 blades with Japanese Tothing for cutting wood, chipboard, plasterboard and plastics.
- 2 blades in BIM for cutting wood products, chipboard, plasterboard, fiberglass, epoxy resins, soft plastics, sheet metal, aluminium pipes and profiles. Cuts through embedded nails in wood up to 5mm in diameter as well as porous concrete.

WOOD **WOOD&NAILS**

8 Sets in End-cap display
(minimum order 8 sets)



PACK Quantity	MATERIAL	W mm	I mm	TPI	ORDER NO.
1	HCS	34	40	14	OMM04-X1
1	HCS	68	40	14	OMM06-X1
1	BIM	34	40	18	OMM12-X1
1	BIM	45	48	18	OMM15-X1

OMM-X33

Universal Arbor



6 Sets Masterpack

33 piece General Purpose Set for Multi-Cutters

- blades for cutting wood, plastic, plasterboard, sheet metal, profiles and pipes in aluminum and copper.
- scraper to remove carpet adhesive/glue residues as well as paint and silicone residues.
- sanding pad and sanding sheets (60, 100, 180 grit).

PACK Quantity	W mm	I mm	TPI	GRIT	ORDER NO.
1	34	40	18		OMM12-X1
1	52	45			OMM20-X1
1	93				OMM30-X1
10	93			60	OMA30060-X10
10	93			100	OMA30100-X10
10	93			180	OMA30180-X10

OMM-X37

Universal Arbor



Front



Back

37 piece General Purpose Set for Multi-Cutters

- blades (in two diameters) for cutting in wood, plastic, plasterboard, sheet metal, profiles and pipes in aluminum and copper.
- segmented blade for cutting wood and metal.
- scraper for removing carpet adhesive/glue residues as well as paint and silicone residues.
- rasp in carbide for grinding/sanding/removal of tiles, plasterboard, cement, wood and construction materials.
- specially designed blade to remove mortar, bonding materials, cement and stone, even in hard to reach corners.
- sanding pad and sanding sheets (60, 100, 180 grit).

PACK Quantity	W mm	I mm	TPI	GRIT	ORDER NO.
1	10	28	18		OMM09-X1
1	34	40	18		OMM12-X1
1	87		20		OMM17-X1
1	52	45			OMM20-X1
1	80				OMM25-X1
1	65				OMM29-X1
1	93			10	OMM30-X1
10	93			60	OMA30060-X10
10	93			100	OMA30100-X10
10	93			180	OMA30180-X10

4 Sets in End-cap display
(minimum order 4 sets)



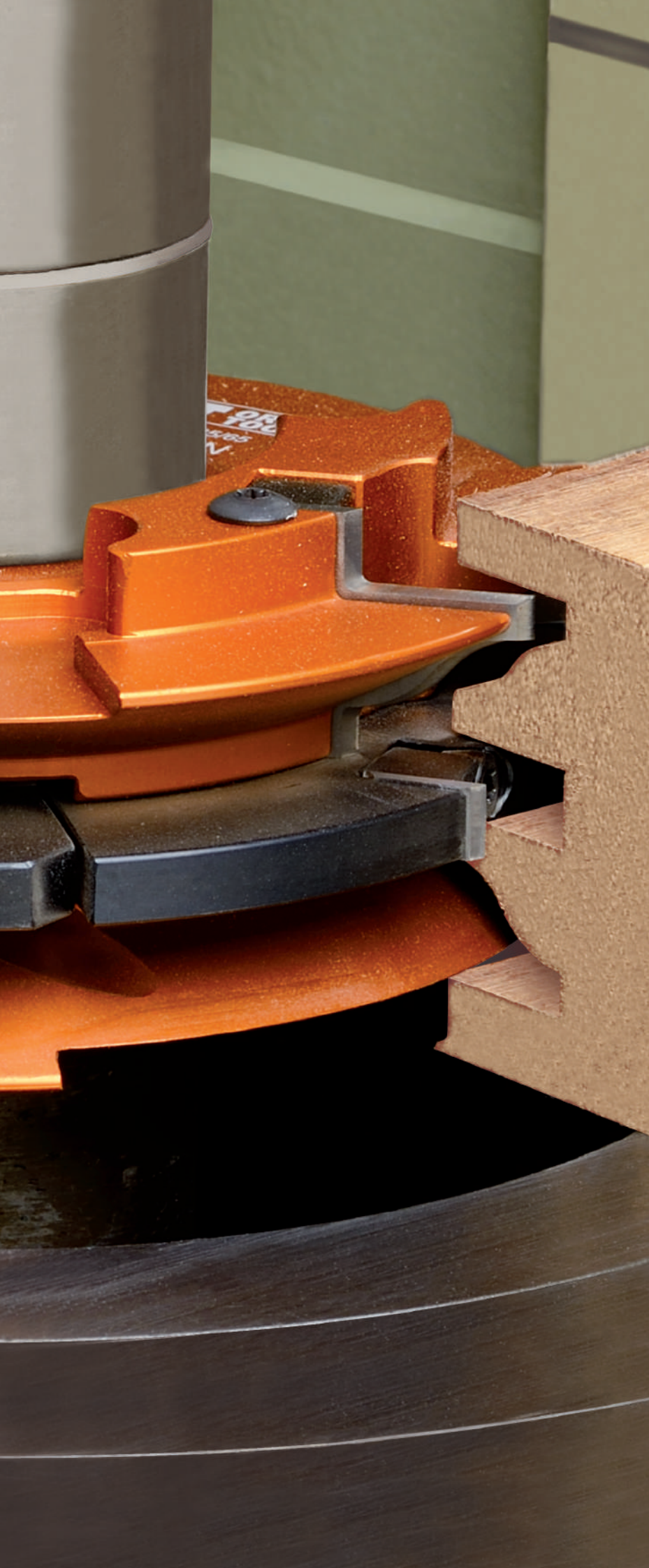

TOOLS WITH BORE & KNIVES

PRODUCTS	PAGE
Rabbeting Cutter Heads	122-123
Adjustable Grooving Set	124-125
Planing & Jointing Spiral Cutter Heads	126
2 piece Adjustable Rounding & Chamfering Set	127
Chamfer Cutter Heads	128-129
Multiradius Roundover Cutter Heads	130-132
Jointing Cutter Heads	133-135
Panel Cutter Heads	136-140
Cutter Heads with Universal Knives & Sets	141-143
Profile Knives & Limiters	144-156
Blank Knives & Limiters (to be sharpened)	157
Bore Reducers	157
HWM Reversible Knives for Portable Planers	158
HS Corrugated Back Moulder Knives	159
Magnetic Knife Setting Jigs	159
Planer & Jointer Knives	160-161
HWM Reversible Knives	162-163





694.100

These cutter heads have been designed for:

- rabbeting from either top or bottom;
- jointing
- grooving

For use on spindle moulder machines, double-end tenoner and edging machines.

Suitable for all materials, but best on chipboard, MDF, wood composites, plastic materials and laminates. Improved design with shear angle.

TECHNICAL DETAILS:

- Hard aluminium alloy body with high resistance to tensile and yield stress.
- 2 universal HWM straight knives 50x12x1,5mm [Z2], 1 up cut - 1 down cut.
- 4 universal HWM scoring knives 14x14x2mm [V4].
- Tools for manual feed (MAN).
- Pins for automatic positioning of the knives.

SAFETY TIPS:



The **TW-006** Torque Screwdriver is recommended for the proper fastening of screws (see page 406).

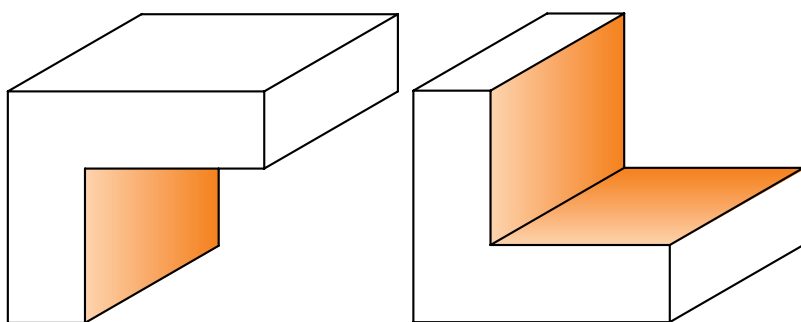

Supplied in a sturdy plastic carry case

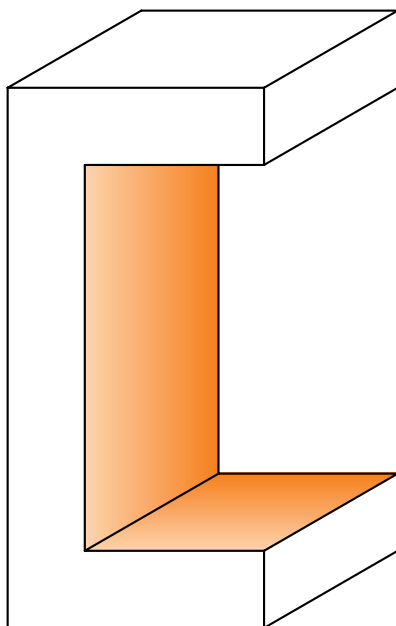

Drawing is 1:1 scale

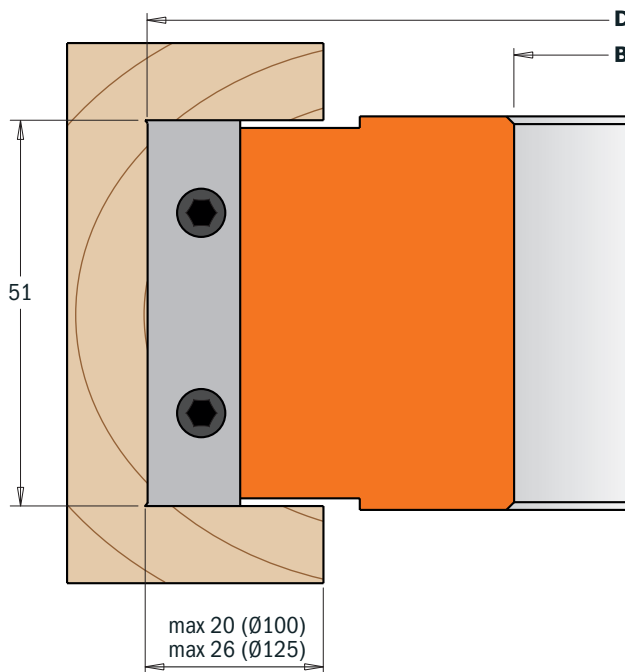

D mm	B mm	I mm	Z+V	RPM		ORDER NO.							
100	19,05	51	2+4	7500~12500	1	694.100.19	790.140.00*	990.093.00	991.073.00	790.500.00*	695.999.46	990.064.00	991.064.00
100	30	51	2+4	7500~12500	1	694.100.30	790.140.00*	990.093.00	991.073.00	790.500.00*	695.999.46	990.064.00	991.064.00
100	31,75	51	2+4	7500~12500	1	694.100.31	790.140.00*	990.093.00	991.073.00	790.500.00*	695.999.46	990.064.00	991.064.00
100	35	51	2+4	7500~12500	1	694.100.35	790.140.00*	990.093.00	991.073.00	790.500.00*	695.999.46	990.064.00	991.064.00
125	40	51	2+4	6100~10000	1	694.125.40	790.140.00*	990.093.00	991.073.00	790.500.00*	695.999.46	990.064.00	991.064.00
125	50	51	2+4	6100~10000	1	694.125.50	790.140.00*	990.093.00	991.073.00	790.500.00*	695.999.46	990.064.00	991.064.00

Spare parts

*Minimum 10 pieces or multiple

Cutter Heads for Rabbeting with 40mm Profile Knives



694.020

- These cutter heads have been designed for:
- rabbeting from either top or bottom;
 - jointing
 - grooving
 - profile knives on pages 118-127



For use on spindle moulder machines, moulder, double-end tenoners and edging machines. Suitable for all materials, but best on chipboard, MDF, wood composites, plastic materials and laminates.

TECHNICAL DETAILS:

- Hard aluminium alloy body with high resistance to tensile and yield stress.
- 2 universal HWM straight knives 40x12x1,5mm [Z2].
- 2 universal HWM scoring knives 14x14x2mm [V2].
- Tools for manual feed (MAN).
- Pins for the automatic positioning of the knives.

SAFETY TIPS:



The **TW-006** Torque Screwdriver is recommended for the proper fastening of screws (see page 406).

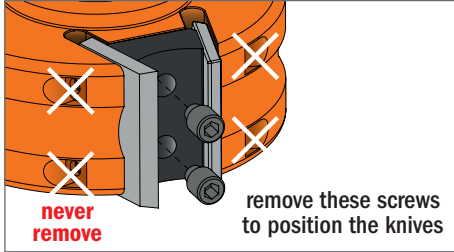

Supplied in a sturdy plastic carry case

Drawing is 1:1 scale

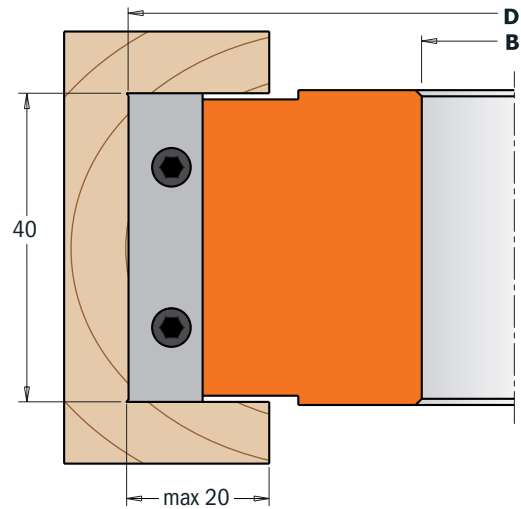
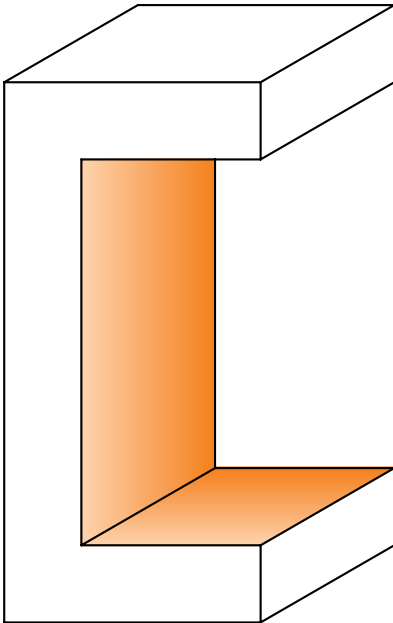

To use with all 40mm profile knives (refer to pages 144 to 153)

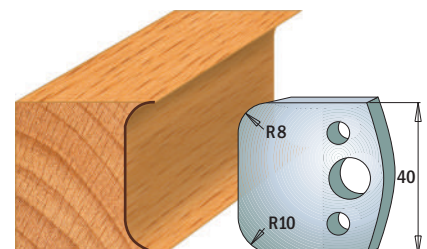
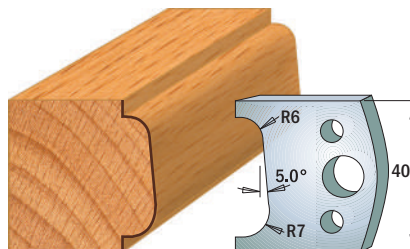
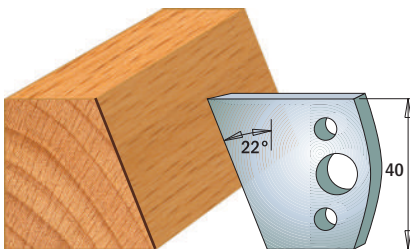

D mm	B mm	I mm	Z+V	RPM		ORDER NO.
100	30	40	2+2	5800~9000	1	694.020.30
100	31,75	40	2+2	5800~9000	1	694.020.31
125	35	40	2+2	4800~7400	1	694.020.35
125	40	40	2+2	4800~7400	1	694.020.40
125	50	40	2+2	4800~7400	1	694.020.50

Spare parts

790.140.00*	990.093.00	991.073.00	790.400.00*	693.999.01	990.065.00	991.064.00
790.140.00*	990.093.00	991.073.00	790.400.00*	693.999.01	990.065.00	991.064.00
790.140.00*	990.093.00	991.073.00	790.400.00*	693.999.01	990.065.00	991.064.00
790.140.00*	990.093.00	991.073.00	790.400.00*	693.999.01	990.065.00	991.064.00
790.140.00*	990.093.00	991.073.00	790.400.00*	693.999.01	990.065.00	991.064.00

Spare parts: **691.192** Pair of limiters 38mm
695.020.01 Indexable knife edge block 38x4x15mm

*Minimum 10 pieces or multiple

3-Piece Adjustable Grooving Sets



694.001

These cutter heads are the ideal tools to create precision slots and grooves 4-15mm in depth.

These sets include:

- 2 cutter heads type **(A)** [Z4 + V4]
- 1 cutter head type **(B)** [Z2]
- 12 spacer rings from 0,1 to 2mm

For use on spindle moulder machines, moulder, double-end tenoner and edging machines. Perfect grooving on all materials, but ideal on hardwood, plywood and laminated panels.

TECHNICAL DETAILS:

- Super-strength steel body.
- 2 HWM Knives 7,65x12x1,5mm [Z2].
- 4 HWM Knives 18x18x1,95mm [Z4].
- 4 HWM Knives 14x14x1,2mm [V4].
- Tools for manual feed (MAN).
- Pins for automatic positioning of the knives.

SAFETY TIPS:



The **TW-006** Torque Screwdriver is recommended for the proper fastening of screws (see page 406).



Supplied in a sturdy plastic carry case

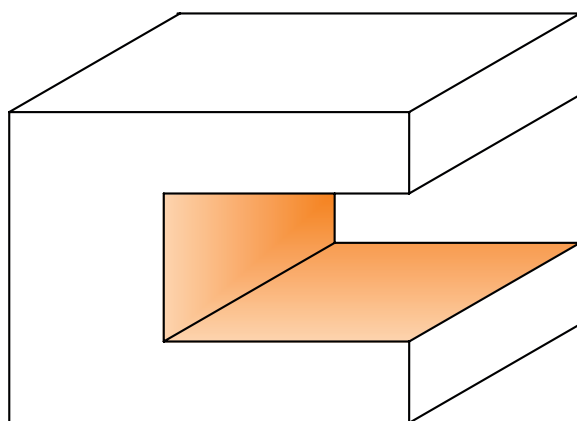
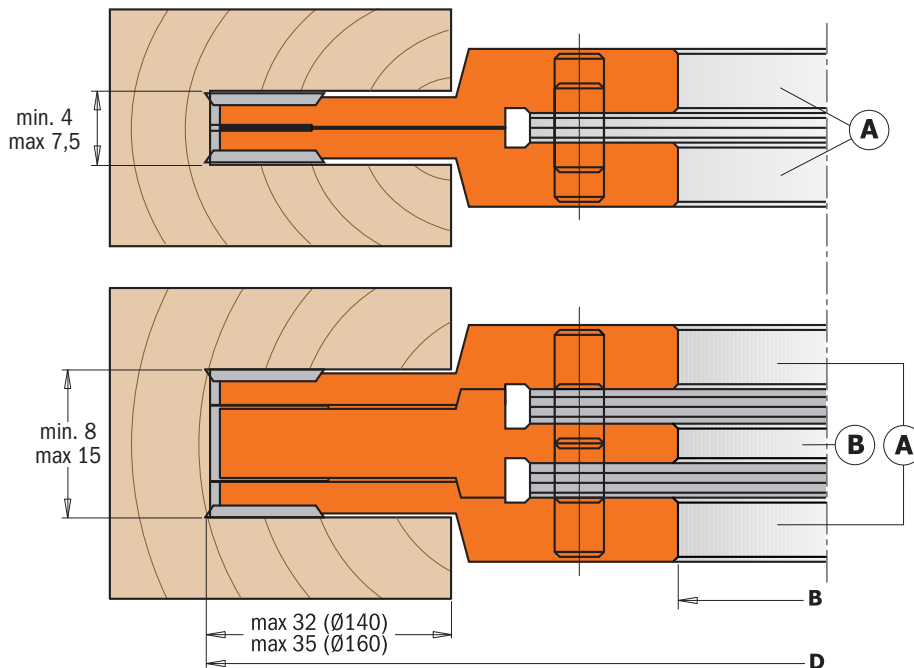

Drawing is 1:1 scale

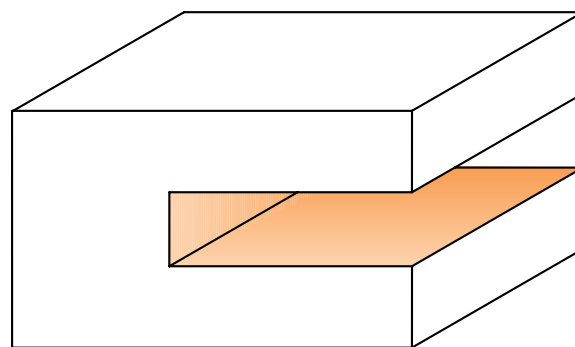

D mm	B mm	Z+V	RPM		ORDER NO.
140	30	4+4	5500~9500	1	694.001.30
140	31,75	4+4	5500~9500	1	694.001.31
140	35	4+4	5500~9500	1	694.001.35
160	40	4+4	4800~8300	1	694.001.40
160	50	4+4	4800~8300	1	694.001.50

Spare parts

790.181.00*	790.140.10*	790.076.00*	695.998.21
790.181.00*	790.140.10*	790.076.00*	695.998.22
790.181.00*	790.140.10*	790.076.00*	695.998.23
790.181.00*	790.140.10*	790.076.00*	695.998.24
790.181.00*	790.140.10*	790.076.00*	695.998.25

Spare parts: For cutter heads (A)

- 990.079.00** M4x3,2mm TORX® screws
- 991.069.00** T9 TORX® key
- 695.996.02** M4 (Ø12x1,7mm) threaded ring
- 695.996.01** M4 (Ø10x1,6mm) threaded ring

For cutter heads (B)

- 695.999.07** 7x11x9,5mm wedge for knives
- 990.063.00** M5x18mm screw
- 991.072.00** T20 TORX® key

*Minimum 10 pieces or multiple

2-Piece Adjustable Grooving Sets



694.021 - 694.022



These cutter heads are the perfect tools to create precision slots and grooves 14 - 39mm in depth. This set includes:

- 1 cutter head type (A) [Z2 + V2]
- 1 cutter head type (B) [Z2 + V2]
- set of spacer rings.

For use on spindle moulder machines, moulders, double-end tenoners and edging machines. Perfect grooving on all materials, but ideal on hard wood, plywood and laminated panels.



Supplied in a sturdy plastic carry case

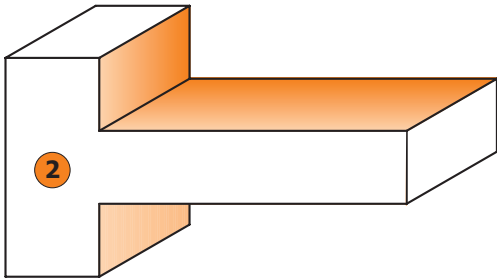
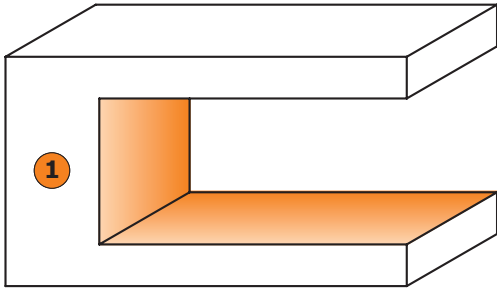

Drawing is 1:1 scale

TECHNICAL DETAILS:

- Super-strength hard aluminium alloy body.
- 694.021: 8 HWM knives 13,6x13,6x2mm.
- 694.022: 4 HWM knives 19,5x12x1,5mm.
4 HWM knives 14x14x2mm.
- Tools for manual feed (MAN).
- Pins for the automatic positioning of the knives.

SAFETY TIPS:

The **TW-006** Torque Screwdriver is recommended for the proper fastening of screws (see page 406).

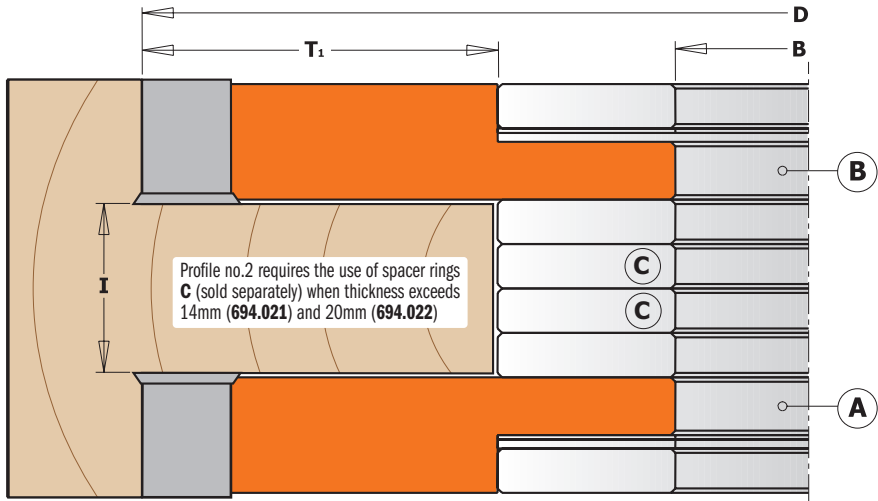
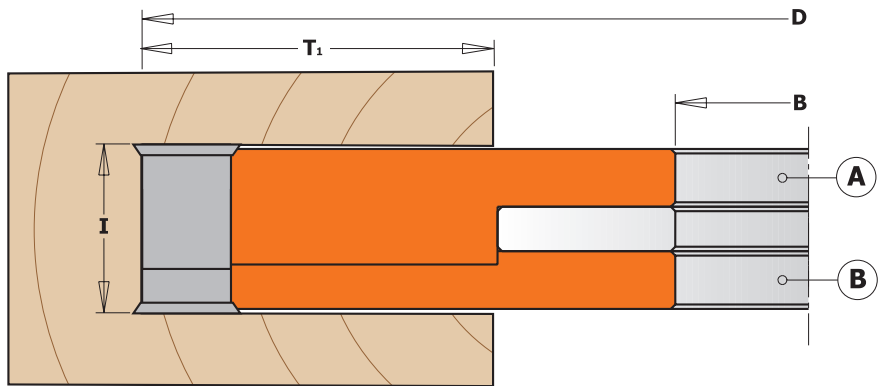

299 Spacer Rings (Optional)

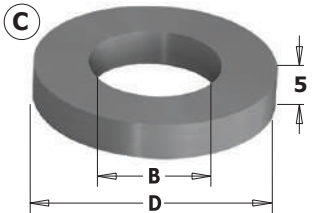

B mm	D mm	ORDER NO.
30	60	299.560.30
31,75	60	299.560.31
35	60	299.560.35
40	60	299.560.40
50	70	299.570.50

D mm	I mm	B mm	T ₁ mm	Z+V	RPM		ORDER NO.
150	14-27	30	44	4+4	5000~8000	1	694.021.30
150	14-27	31,75	44	4+4	5000~8000	1	694.021.31
150	14-27	35	44	4+4	5000~8000	1	694.021.35
150	14-27	40	44	4+4	5000~8000	1	694.021.40
160	14-27	50	44	4+4	5000~8000	1	694.021.50
170	20-39	30	54	4+4	4400~7400	1	694.022.30
170	20-39	31,75	54	4+4	4400~7400	1	694.022.31
170	20-39	35	54	4+4	4400~7400	1	694.022.35
170	20-39	40	54	4+4	4400~7400	1	694.022.40
170	20-39	50	49	4+4	4400~7400	1	694.022.50

Spare parts

790.136.00*	990.093.00			695.998.41
790.136.00*	990.093.00			695.998.42
790.136.00*	990.093.00			695.998.43
790.136.00*	990.093.00			695.998.44
790.136.00*	990.093.00			695.998.45
790.140.00*	990.093.00	790.195.12*	990.094.00	695.998.46
790.140.00*	990.093.00	790.195.12*	990.094.00	695.998.47
790.140.00*	990.093.00	790.195.12*	990.094.00	695.998.48
790.140.00*	990.093.00	790.195.12*	990.094.00	695.998.49
790.140.00*	990.093.00	790.195.12*	990.094.00	695.998.50

Spare parts: 991.072.00 T20 TORX® key
991.073.00 T25 TORX® key

*Minimum 10 pieces or multiple



694.019

These new cutter heads have been designed for planing and jointing soft or solid wood panels on spindle moulder machines. Ideal for routing curved elements with the aid of a bearing guide (sold separately) and a guide fence.

TECHNICAL DETAILS:

- Hard aluminium alloy body with high resistance to tensile and yield stress.
- 12 HWM Knives 14x14x2mm [Z2] with 4 spiral indexing.
- Tools for manual feed (MAN).

Supplied in a sturdy plastic twistpack.

SAFETY TIPS:



The **TW-006** Torque Screwdriver is recommended for the proper fastening of screws (see page 406).

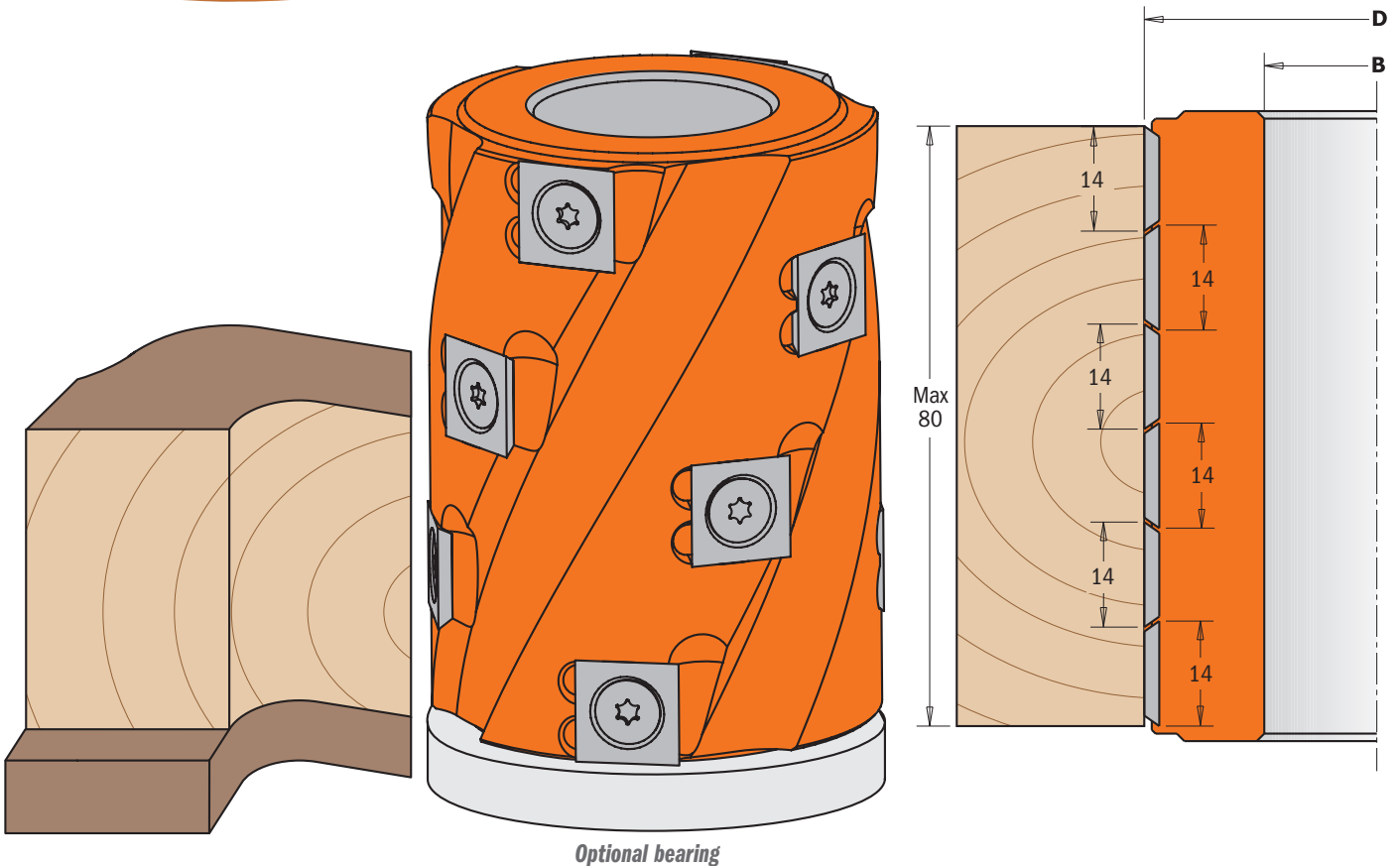

Optional bearing

D mm	I mm	B mm	Z	RPM		ORDER NO.
62	80	30	12	8000~12000	1	694.019.30
62	80	35	12	8000~12000	1	694.019.35
80	80	40	12	8000~12000	1	694.019.40
80	80	50	12	8000~12000	1	694.019.50

Spare parts

790.140.00*	990.093.00	991.073.00
790.140.00*	990.093.00	991.073.00
790.140.00*	990.093.00	991.073.00
790.140.00*	990.093.00	991.073.00

- Optional: **791.051.00** 30x62x16mm bearing
791.052.00 35x62x14mm bearing
791.054.00 40x80x18mm bearing
791.053.00 50x80x16mm bearing

*Minimum 10 pieces or multiple

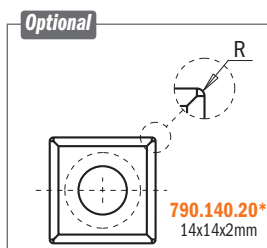

NOTE: Ideal for working curved elements together with the appropriate bearing (sold separately) and a guide fence. In order to achieve an extra-fine finish, order the optional knife **790.140.20***

2-Piece Adjustable Rounding & Chamfering Sets



Supplied in a sturdy plastic carry case

694.005

The CMT adjustable rounding and chamfering set consists of two pieces for easy to set up on your spindle moulder machine. Includes five different knives for rounding over top and bottom edges in one single pass with a radius of 2,3,4,5 or 6mm and for 45° chamfering on material 18mm to 50mm in thickness. The improved design with shear angle guarantees perfect finishing!
For use on spindle moulder machines.

TECHNICAL DETAILS:

- Hard aluminium alloy body with high resistance to tensile and yield stress.
- One pair of HWM top knives (A) radius 4mm and 45° chamfer (20x20,5x2mm) [Z2].
- One pair of HWM bottom knives (B) radius 4mm and 45° chamfer (20x20,5x2mm) [Z2].
- Two HWM knives 50x12x1,5mm.
- Set of 21 spacer rings from 0,1 to 3mm
- Tools for manual feed (MAN)
- Pins for the automatic positioning of the knives.

SAFETY TIPS:



The **TW-006** Torque Screwdriver is recommended for the proper fastening of screws (see page 406).

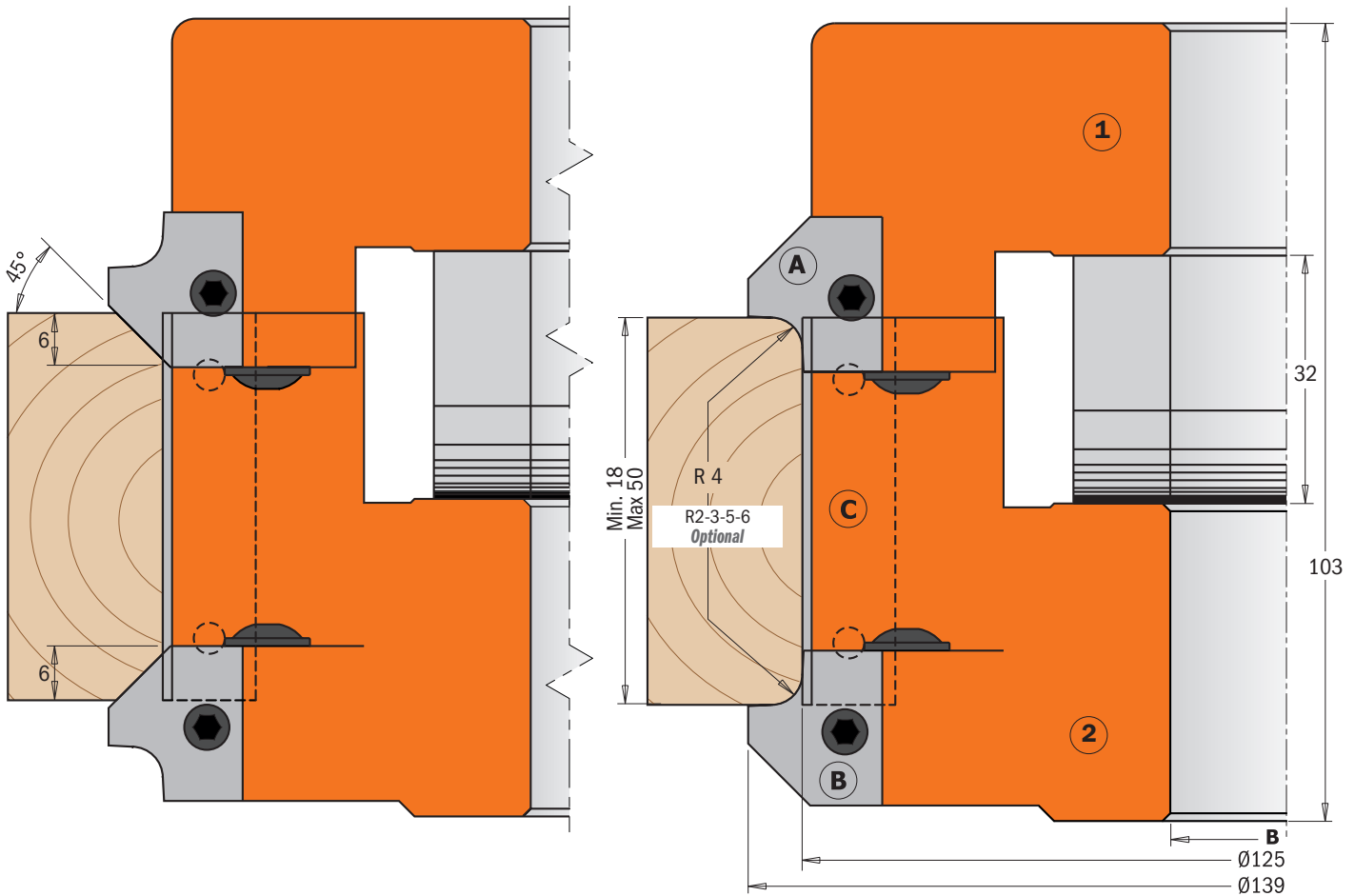

D mm	B mm	Z	RPM		ORDER NO.
139	30	2+2	5500~8400	1	694.005.30
139	31,75	2+2	5500~8400	1	694.005.31
139	35	2+2	5500~8400	1	694.005.35
139	40	2+2	5500~8400	1	694.005.40
139	50	2+2	5500~8400	1	694.005.50

Spare parts

17x11x9,5mm	46x11x9,5mm		
695.999.17	695.999.46	990.064.00	695.998.11
695.999.17	695.999.46	990.064.00	695.998.12
695.999.17	695.999.46	990.064.00	695.998.13
695.999.17	695.999.46	990.064.00	695.998.14
695.999.17	695.999.46	990.064.00	695.998.15

Spare parts: **695.005.A4** R=4+45° pair of knives for roundover/chamfer (top)
695.005.B4 R=4+45° pair of knives for roundover/chamfer (bottom)
790.500.00 50x12x1,5mm knives
991.064.00 4mm hex key
991.067.00 3mm hex key

Optional: **695.005.A2** R=2+45° pair of knives for roundover/chamfer (top)
695.005.A3 R=3+45° pair of knives for roundover/chamfer (top)
695.005.A5 R=5+45° pair of knives for roundover/chamfer (top)
695.005.A6 R=6+45° pair of knives for roundover/chamfer (top)
695.005.B2 R=2+45° pair of knives for roundover/chamfer (bottom)
695.005.B3 R=3+45° pair of knives for roundover/chamfer (bottom)
695.005.B5 R=5+45° pair of knives for roundover/chamfer (bottom)
695.005.B6 R=6+45° pair of knives for roundover/chamfer (bottom)

45° Chamfer Cutter Heads



694.002

CMT chamfer cutter heads carry out clean accurate bevels and joints for excellent edge work. For use on spindle moulder machines, moulder, double-end tenoners, edge banding machines. Suitable for all materials, but ideal on hardwood, plywood and laminated panels.

TECHNICAL DETAILS:

- Hard aluminium alloy body with high resistance to tensile and yield stress.
- 2 HWM Knives 50x12x1,5mm [Z2].
- Tools for manual feed (MAN).
- Pins for the automatic positioning of the knives



Supplied in a sturdy plastic carry case

SAFETY TIPS:



The **TW-006** Torque Screwdriver is recommended for the proper fastening of screws (see page 406).

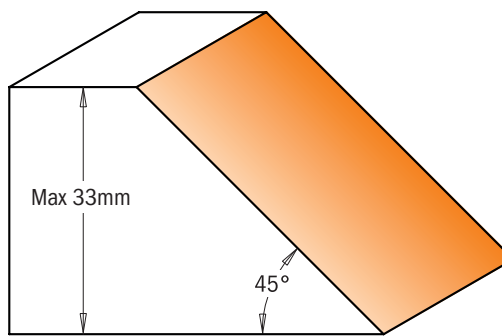
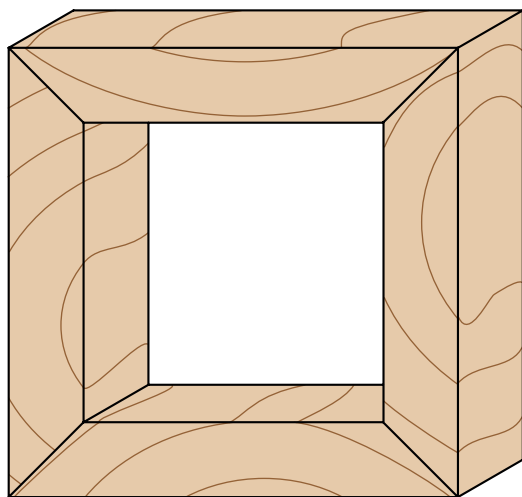
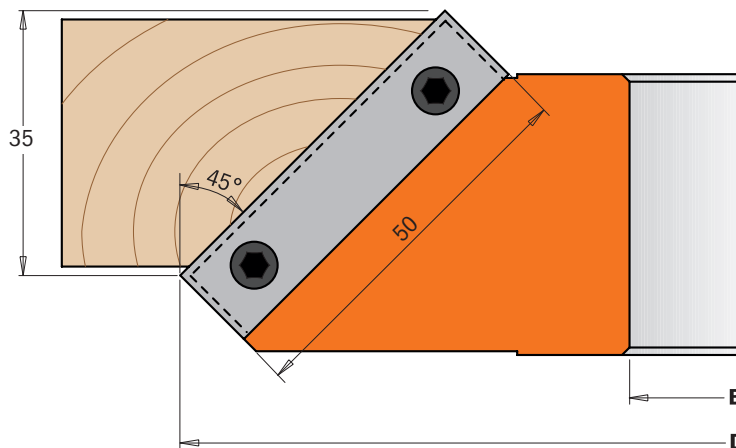

Drawing is 1:1 scale

D mm	B mm	Z	RPM		ORDER NO.
150	30	2	5100~8800	1	694.002.30
150	31,75	2	5100~8800	1	694.002.31
150	35	2	5100~8800	1	694.002.35
150	40	2	5100~8800	1	694.002.40
160	50	2	5100~8800	1	694.002.50

Spare parts

790.500.00*	695.999.42	990.064.00	991.064.00
790.500.00*	695.999.42	990.064.00	991.064.00
790.500.00*	695.999.42	990.064.00	991.064.00
790.500.00*	695.999.42	990.064.00	991.064.00
790.500.00*	695.999.42	990.064.00	991.064.00

*Minimum 10 pieces or multiple

Adjustable Chamfer Cutter Heads with Positive Stop



694.018

This adjustable chamfer cutter head carries out very precise cuts on solid boards. For use on spindle moulding machines, moulder, double-end tenoners and edging machines.

TECHNICAL DETAILS:

- Tool body made from high strength aluminum alloy extremely resistant to tensile and yield stress
- Manual feed tool (MAN)
- 2 HWM knives 40x12x1,5mm [Z2]
- Adjustable swivelling blades
- Range: $\pm 45^\circ$ (Rotates at $7,5^\circ$ intervals; Precision = $7,5^\circ$)



Supplied in a sturdy plastic carry case

SAFETY TIPS:

The **TW-006** Torque Screwdriver is recommended for the proper fastening of screws (see page 406).

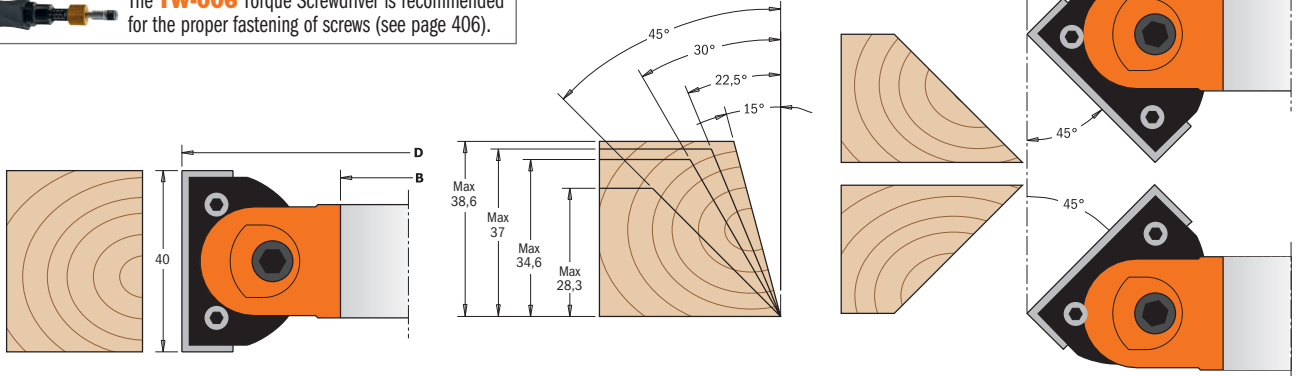

D mm	I mm	B mm	Z	D_Max 45° mm	RPM		ORDER NO.
120	40	30	2	140	6400~8500	1	694.018.30
120	40	35	2	140	6400~8500	1	694.018.35
145	40	40	2	165	5900~7400	1	694.018.40
145	40	50	2	165	5900~7400	1	694.018.50

Spare parts

695.018.01	790.400.00*	990.094.00	991.072.00
695.018.01	790.400.00*	990.094.00	991.072.00
695.018.01	790.400.00*	990.094.00	991.072.00
695.018.01	790.400.00*	990.094.00	991.072.00

Spare parts: 991.065.00 5mm hex key

*Minimum 10 pieces or multiple

Professional Adjustable Chamfer Cutter Heads

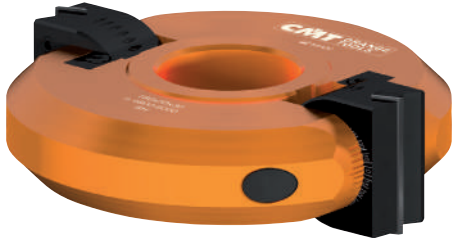

694.017

These new professional adjustable chamfer cutter heads carry out precise cuts, accurate bevels and joint work on solid wooden boards. For use on spindle moulder machines, moulder, double-end tenoner and edging machines.

SAFETY TIPS:

The **TW-006** Torque Screwdriver is recommended for the proper fastening of screws (see page 406).



Supplied in a sturdy plastic carry case

TECHNICAL DETAILS:

- Tool body made from high strength aluminum alloy extremely resistant to tensile and yield stress
- Manual feed tool (MAN)
- 2 HWM knives 50x12x1,5mm [Z2]
- Adjustable swivelling blades
- Range $\pm 90^\circ$ (Rotates at $7,5^\circ$ intervals; Precision = $7,5^\circ$)

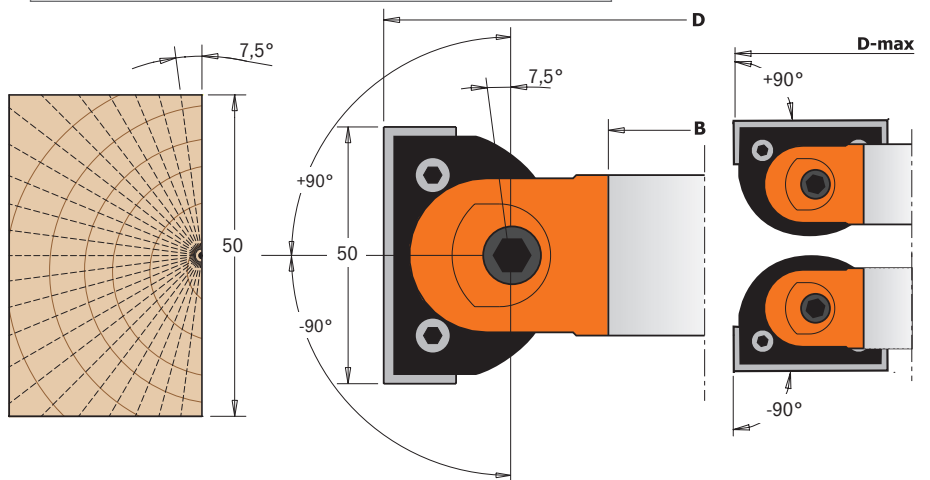

D mm	I mm	B mm	Z	D_Max 45° mm	RPM		ORDER NO.
160	50	30	2	183	4800~6000	1	694.017.30
160	50	35	2	183	4800~6000	1	694.017.35
160	50	50	2	183	4800~6000	1	694.017.50

Spare parts

695.017.01	790.500.00*	695.999.48	990.106.00	991.067.00
695.017.01	790.500.00*	695.999.48	990.106.00	991.067.00
695.017.01	790.500.00*	695.999.48	990.106.00	991.067.00

Spare parts: 991.081.00 4mm hex key

*Minimum 10 pieces or multiple

Multiradius Roundover Cutter Heads



694.003

Innovative cutter heads featuring three different knives for making six radius roundover profiles. Standard cutter heads are sold with knives featuring 5 and 10mm radii; two more knife sets are available for making 4-8mm and 3-6mm radii. For use on spindle moulder machines, moulder machines and shaping machines. Suitable for all materials, but ideal on hard wood and panels.

TECHNICAL DETAILS:

- Hard aluminium alloy body with high resistance to tensile and yield stress.
- 2 HWM knives radius 5/10mm (25x24,8x2mm) [Z2].
- Tools for manual feed (MAN).
- Pins for the automatic positioning of the knives.

SAFETY TIPS:



The **TW-006** Torque Screwdriver is recommended for the proper fastening of screws (see page 406).

Standard

Pair of knives **695.003.05**

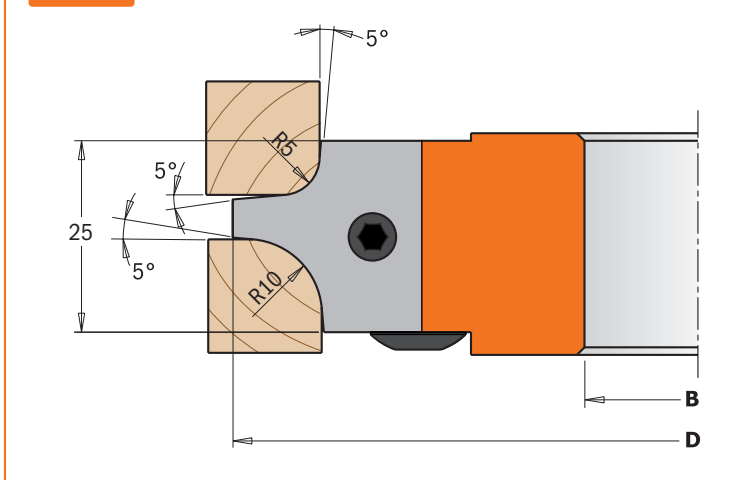

Supplied in a sturdy plastic carry case

Optional

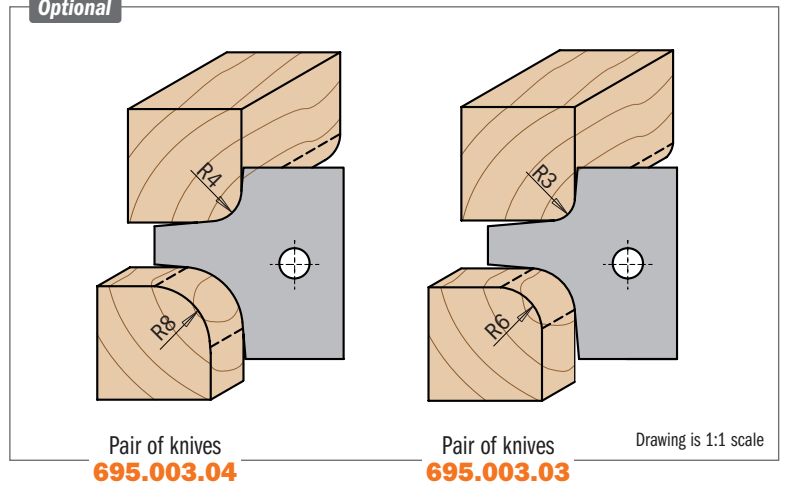

D mm	B mm	Z	RPM		ORDER NO.
113	30	2	6700~11000	1	694.003.30
113	31,75	2	6700~11000	1	694.003.31
113	35	2	6700~11000	1	694.003.35
128	40	2	5900~9700	1	694.003.40
128	50	2	5900~9700	1	694.003.50

Spare parts

695.003.05 x2	695.999.22	990.064.00	991.064.00
695.003.05	695.999.22	990.064.00	991.064.00
695.003.05	695.999.22	990.064.00	991.064.00
695.003.05	695.999.22	990.064.00	991.064.00
695.003.05	695.999.22	990.064.00	991.064.00

Optional: **695.003.04** R=4/8mm (25x24,8x2mm) pair of profiled knives

695.003.03 R=3/6mm (25x24,8x2mm) pair of profiled knives

Multiradius Roundover Cutter Heads



694.004

Innovative cutter heads supporting two different knives for making four radius roundover profiles. Standard cutter heads are sold with knives featuring 15 and 20mm radii; an additional knife set is available for 12-18mm radii. **For use on spindle moulder machines, moulder and shaping machines.** Suitable for all materials, but ideal on hard wood and wood panels.



TECHNICAL DETAILS:

- Hard aluminium alloy body with high resistance to tensile and yield stress.
- 2 HWM knives radius 15/20mm (45x34,5x2mm) [Z2].
- Tools for manual feed (MAN).
- Pins for the automatic positioning of the knives.

SAFETY TIPS:



The **TW-006** Torque Screwdriver is recommended for the proper fastening of screws (see page 406).

Standard

Pair of knives **695.004.15**

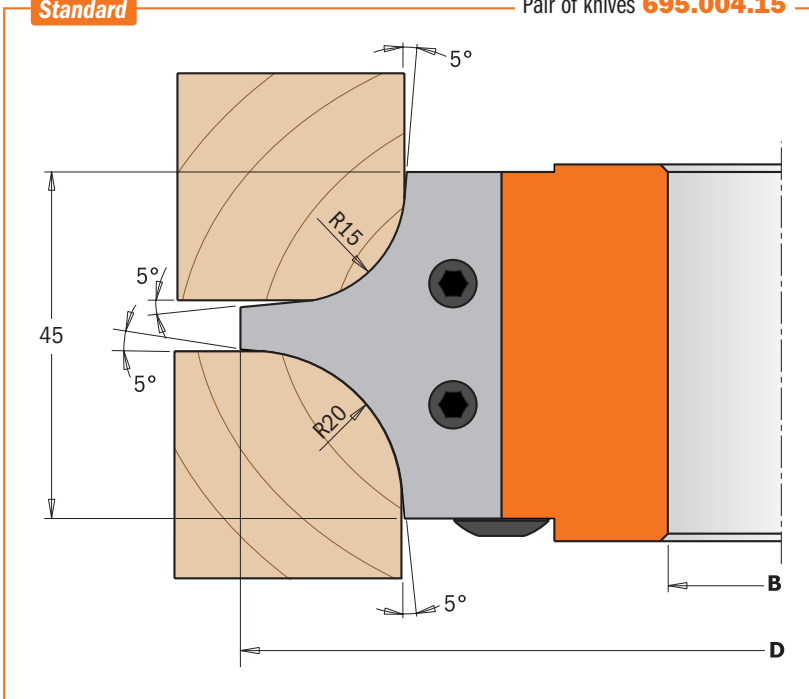

Supplied in a sturdy plastic carry case



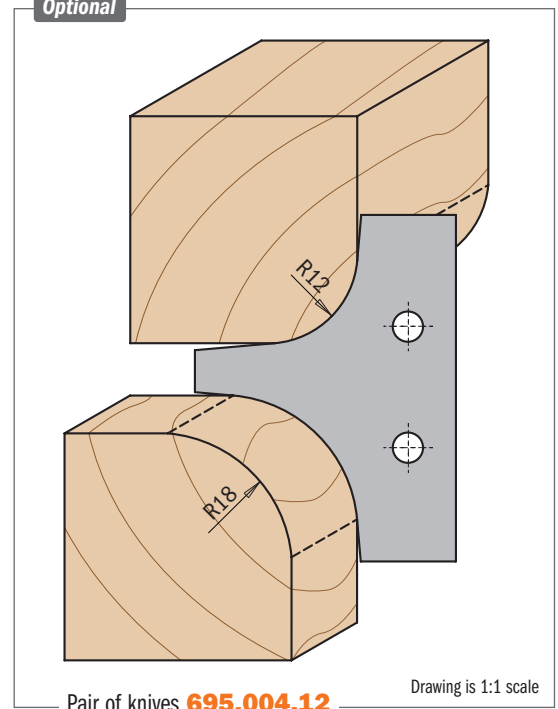

Optional



Pair of knives **695.004.12**

D mm	B mm	Z	RPM		ORDER NO.
132	30	2	5700~9500	1	694.004.30
132	31,75	2	5700~9500	1	694.004.31
132	35	2	5700~9500	1	694.004.35
147	40	2	5100~8500	1	694.004.40
147	50	2	5100~8500	1	694.004.50

Spare parts

 x2			
695.004.15	695.999.42	990.064.00	991.064.00
695.004.15	695.999.42	990.064.00	991.064.00
695.004.15	695.999.42	990.064.00	991.064.00
695.004.15	695.999.42	990.064.00	991.064.00
695.004.15	695.999.42	990.064.00	991.064.00

Optional: **695.004.12** R=12/18mm (45x34,5x2mm) pair of profiled knives



694.007

These cutter heads are perfect for making furniture, doors and drawer fronts simply and stylishly by applying a final touch with a CMT cove bit. It is also used for making perfect roundover profiles, drop leaf counters and table tops. You can use three different knives for carrying out roundover and cove profiles with 10, 12 and 15mm radii. For use on spindle moulder machines, moulder and shaping machines. Suitable for all materials, but ideal on solid wood and panel materials.

TECHNICAL DETAILS:

- Hard aluminium alloy body with high resistance to tensile and yield stress.
- 2 HWM knives radius 10mm (34,8x29,3x2mm) [Z2].
- Tools for manual feed (MAN).
- Pins for the automatic positioning of the knives.

SAFETY TIPS:

The **TW-006** Torque Screwdriver is recommended for the proper fastening of screws (see page 406).



Supplied in a sturdy plastic carry case

Standard

Pair of knives **695.007.10**

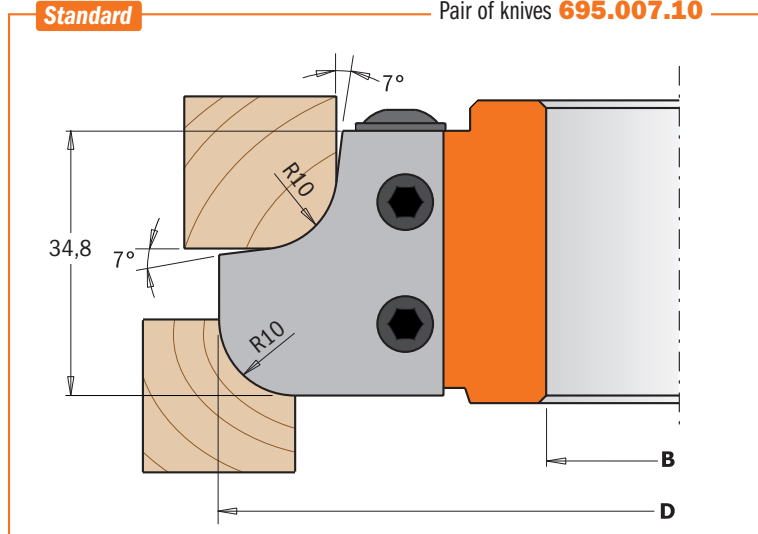

Optional

Pair of knives **695.007.12**

Pair of knives **695.007.15**

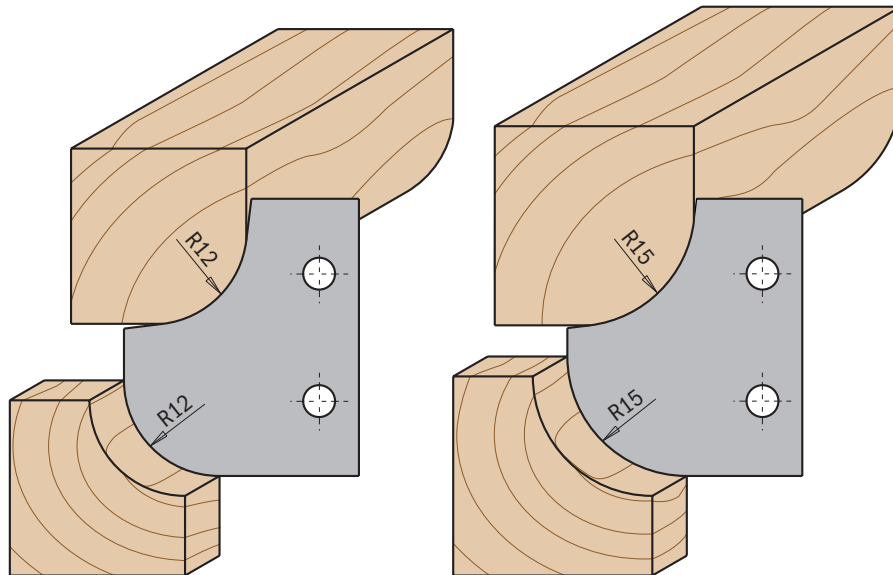

Drawing is 1:1 scale

D mm	B mm	Z	RPM		ORDER NO.
121	30	2	6300~10500	1	694.007.30
121	31,75	2	6300~10500	1	694.007.31
121	35	2	6300~10500	1	694.007.35
136	40	2	5100~8500	1	694.007.40
136	50	2	5100~8500	1	694.007.50

Spare parts

x2			
695.007.10	695.999.31	990.064.00	991.064.00
695.007.10	695.999.31	990.064.00	991.064.00
695.007.10	695.999.31	990.064.00	991.064.00
695.007.10	695.999.31	990.064.00	991.064.00
695.007.10	695.999.31	990.064.00	991.064.00

Optional: **695.007.12** R=12mm (34,8x29,3x2mm) pair of roundover/cove knives
695.007.15 R=15mm (34,8x29,3x2mm) pair of roundover/cove knives

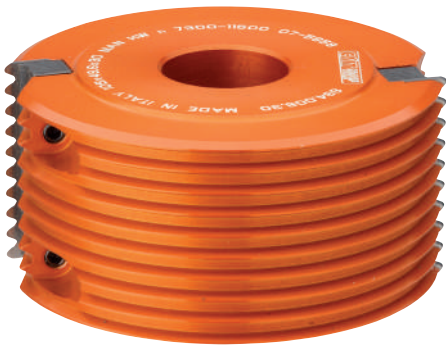

694.008



The CMT professional finger joint cutter head makes the strongest side-to-side joints on all wood types and composites. The tightness of the joint and the maximum surface area for glue application ensure that the joint itself is stronger than an unworked piece of wood. Maximum thickness 47mm.
For use on spindle moulder machines. Perfect for moulding and furniture specialists. Suitable for all materials, but ideal on hard wood and wood panels.

TECHNICAL DETAILS:

- Hard aluminium alloy body with high resistance to tensile and yield stress.
- 2 HWM knives 49,6x11,9x1,5mm [Z2].
- Tools for manual feed (MAN).
- Pins for the automatic positioning of the knives.

SAFETY TIPS:



The **TW-006** Torque Screwdriver is recommended for the proper fastening of screws (see page 406).



Supplied in a sturdy plastic carry case

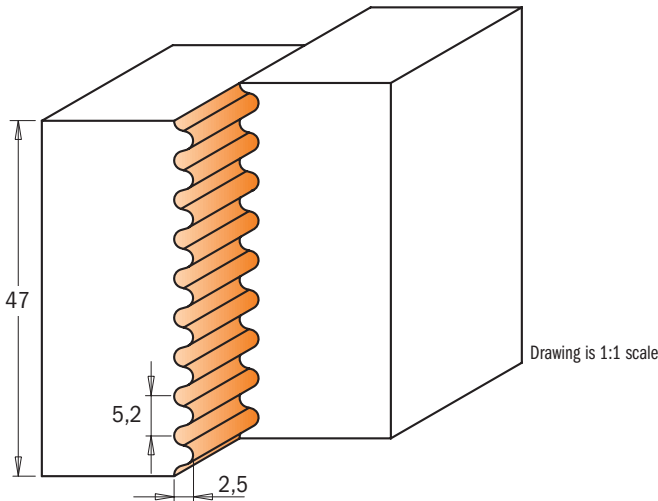
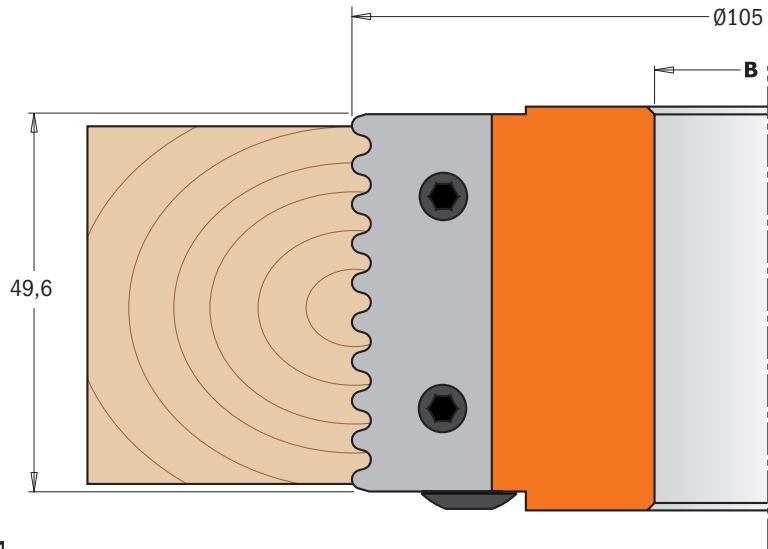

D mm	B mm	Z	RPM		ORDER NO.
105	30	2	7300~11500	1	694.008.30
105	31,75	2	7300~11500	1	694.008.31
105	35	2	7300~11500	1	694.008.35
105	40	2	7300~11500	1	694.008.40
105	50	2	7300~11500	1	694.008.50

Spare parts

x2			
695.008.01	695.999.49	990.066.00	991.067.00
695.008.01	695.999.49	990.066.00	991.067.00
695.008.01	695.999.49	990.066.00	991.067.00
695.008.01	695.999.49	990.066.00	991.067.00
695.008.01	695.999.49	990.066.00	991.067.00

- Optional:**
- 695.998.2630** Ø50x2,6x30mm guide ring
 - 695.998.2631** Ø50x2,6x31,75mm guide ring
 - 695.998.2635** Ø55x2,6x35mm guide ring
 - 695.998.2640** Ø60x2,6x40mm guide ring
 - 695.998.2650** Ø70x2,6x50mm guide ring

Reverse Glue Joint Cutter Heads



694.009

One of the unique characteristics of this CMT cutter head is its capacity to craft indestructible glue joints both quickly and accurately. Ideal for shaping panels, doors and furniture pieces of wide proportion. Simply run one side of the panel, turn the panel over, and then run the opposite side. The result? Perfectly harmonized reverse cuts which match up to produce a flawless joint. Excellent for most materials, but ideal on hard wood, and wood panels.
For spindle moulder machines and double-end tenoners.

TECHNICAL DETAILS:

- Hard aluminium alloy body with high resistance to tensile and yield stress.
- 2 HWM knives 40x18x2mm [Z2].
- Tools for manual feed (MAN).
- Pins for the automatic positioning of the knives.

SAFETY TIPS:



The **TW-006** Torque Screwdriver is recommended for the proper fastening of screws (see page 406).



Supplied in a sturdy plastic carry case

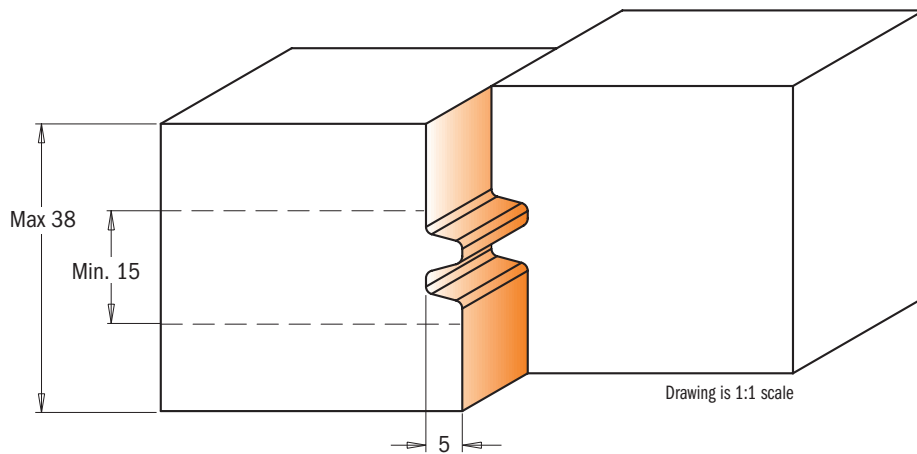
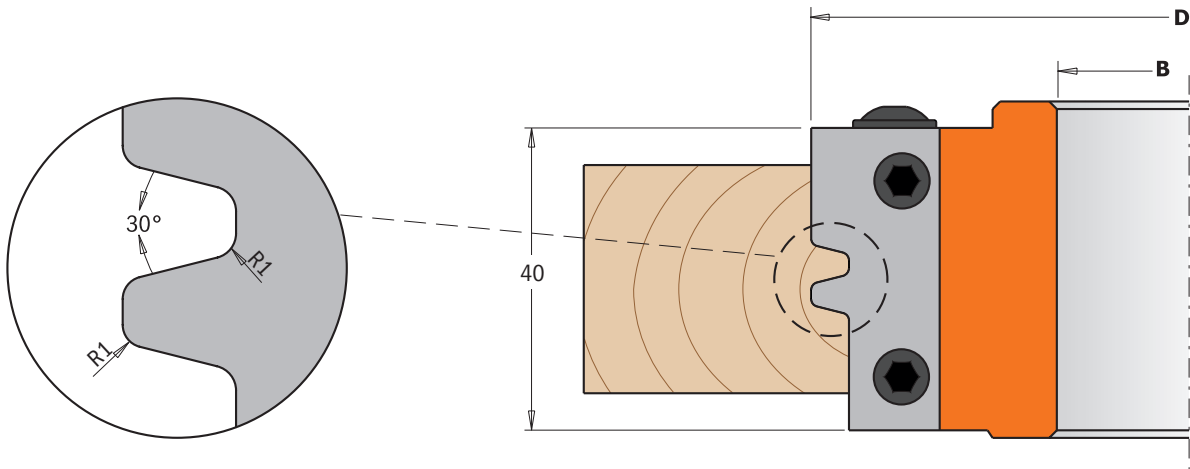

D mm	B mm	Z	RPM		ORDER NO.
100	30	2	7500~12500	1	694.009.30
100	31,75	2	7500~12500	1	694.009.31
100	35	2	7500~12500	1	694.009.35
120	40	2	6400~10500	1	694.009.40
120	50	2	6400~10500	1	694.009.50

Spare parts

x2			
695.009.01	695.999.38	990.064.00	991.064.00
695.009.01	695.999.38	990.064.00	991.064.00
695.009.01	695.999.38	990.064.00	991.064.00
695.009.01	695.999.38	990.064.00	991.064.00
695.009.01	695.999.38	990.064.00	991.064.00



Supplied in a sturdy plastic carry case

694.011



CMT's lock miter cutter heads are ideal for milling miter joints in stock a maximum of 28mm in thickness. Create boxes, stretcher bars, frames and any assortment of right angle (90°) or parallel joint projects. Two easy steps to produce perfect fitting 45° miter joints: first, position and mill your workpiece horizontally, then vertically.

Create parallel glue joints in two steps: position and mill your workpiece horizontally, internal side facing down, and then turn it facing up. For use on spindle moulder machines and shaper machines. Perfect on all materials, but ideal on solid wood and panels.

TECHNICAL DETAILS:

- Hard aluminium alloy body with high resistance to tensile and yield stress.
- 2 HWM knives 43x23x2mm [Z2].
- Tools for manual feed (MAN).
- Pins for the automatic positioning of the knives.

SAFETY TIPS:



The **TW-006** Torque Screwdriver is recommended for the proper fastening of screws (see page 406).

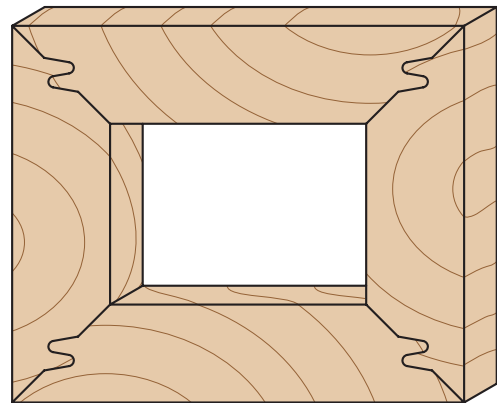
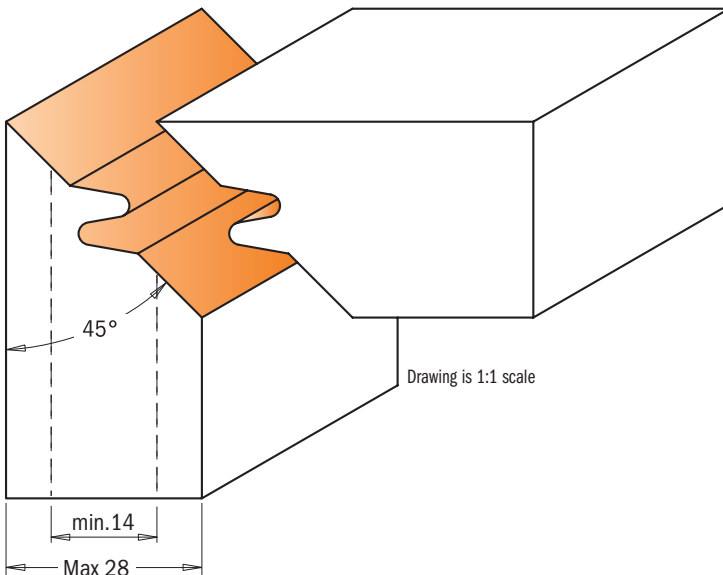
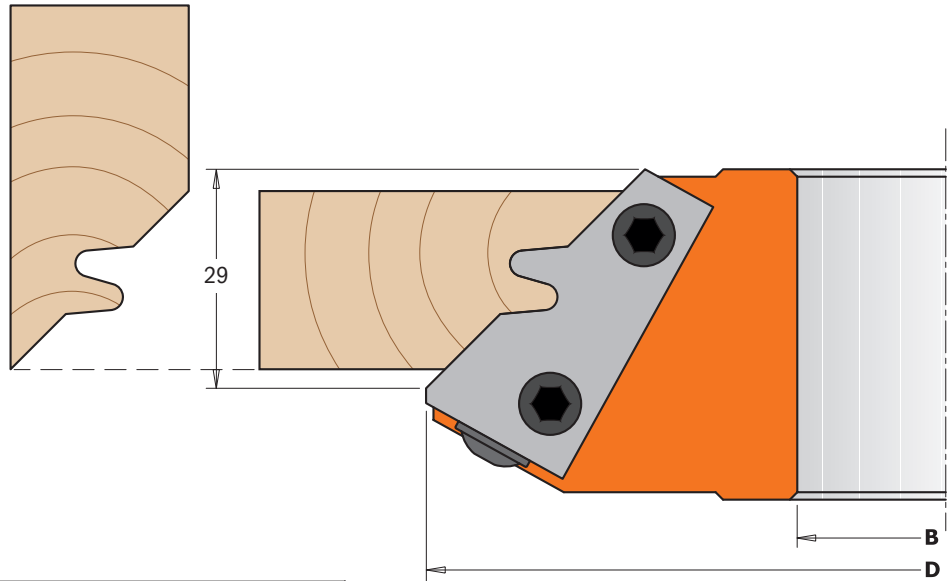

D mm	B mm	Z	RPM		ORDER NO.
140	30	2	5500~9500	1	694.011.30
140	31,75	2	5500~9500	1	694.011.31
140	35	2	5500~9500	1	694.011.35
140	40	2	5500~9500	1	694.011.40
150	50	2	5100~8800	1	694.011.50

Spare parts

x2			
695.011.01	695.999.42	990.064.00	991.064.00
695.011.01	695.999.42	990.064.00	991.064.00
695.011.01	695.999.42	990.064.00	991.064.00
695.011.01	695.999.42	990.064.00	991.064.00
695.011.01	695.999.42	990.064.00	991.064.00

Raised Panel Cutter Heads

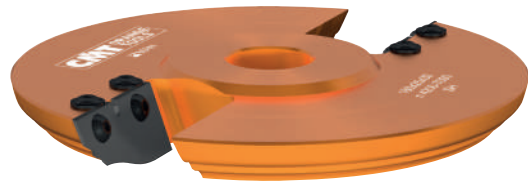

694.012

These new CMT cutter heads will allow you to make classic raised panels on furniture, interior and cabinet doors. An exceptional tool that makes up to six different profiles using the optional knives included. A practical and economical solution. We recommend multiple passes for safe and accurate finishing. For use on spindle moulders and double-end tenoners. Perfect for all materials, but ideal on hard wood and panels.



Supplied in a sturdy plastic carry case

TECHNICAL DETAILS:

- Hard aluminium alloy body with high resistance to tensile and yield stress.
- 2 HWM Knives type (A) 50x25x2mm [Z2].
- Tools for manual feed (MAN)
- Pins for the automatic positioning of the knives.

SAFETY TIPS:



The **TW-006** Torque Screwdriver is recommended for the proper fastening of screws (see page 406).

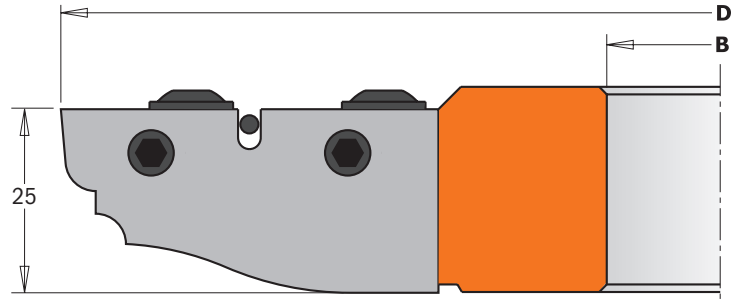

Standard

Pair of knives **695.012A**

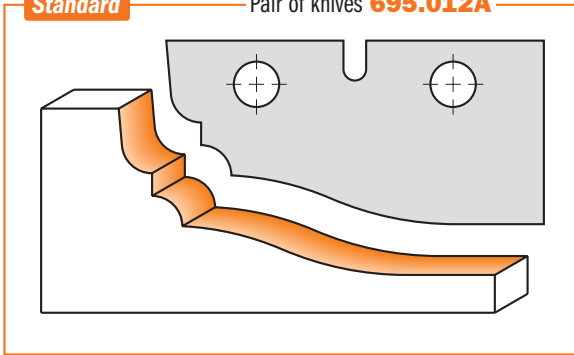

Drawing is 1:1 scale

Optional

Pair of knives **695.012B**

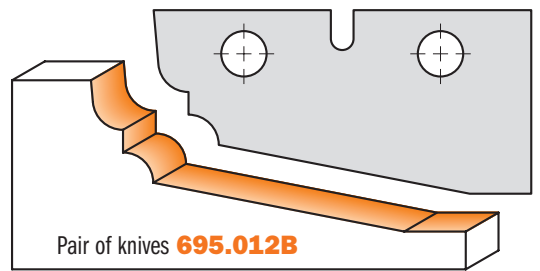

Pair of knives **695.012C**

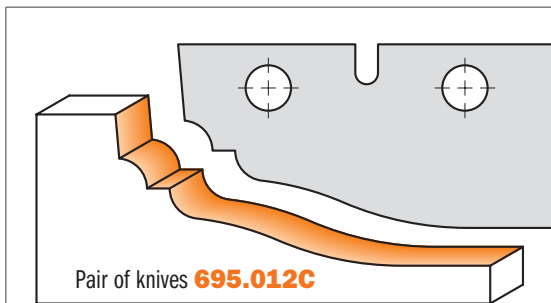

Pair of knives **695.012D**

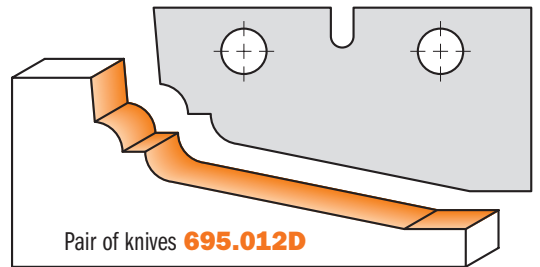

Pair of knives **695.012E**

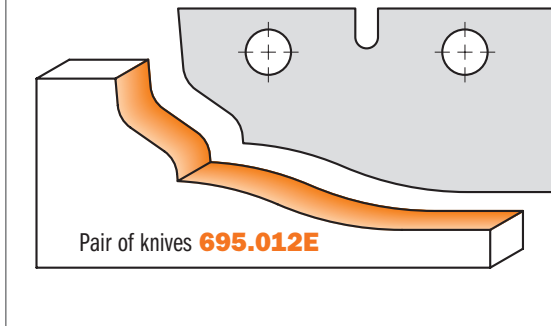

Pair of knives **695.012G**

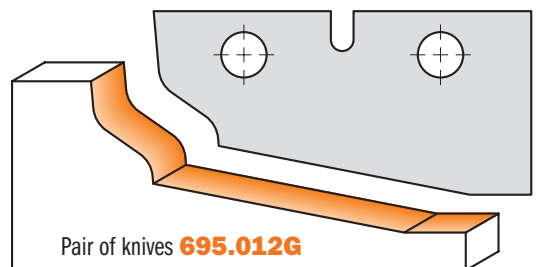

D mm	I mm	B mm	Z	RPM		ORDER NO.
180	25	30	2	4200~7000	1	694.012.30
180	25	35	2	4200~7000	1	694.012.35
180	25	40	2	4200~7000	1	694.012.40
180	25	50	2	4200~7000	1	694.012.50

Spare parts

 x2		
695.012A	990.107.00	991.067.00
695.012A	990.107.00	991.067.00
695.012A	990.107.00	991.067.00
695.012A	990.107.00	991.067.00

Optional: **695.012B** 50x25x2mm pair of knives type (B)
695.012C 50x25x2mm pair of knives type (C)
695.012D 50x25x2mm pair of knives type (D)

695.012E 50x25x2mm pair of knives type (E)
695.012G 50x25x2mm pair of knives type (G)



694.013



We offer a traditional approach to panel construction with these CMT raised panel cutter heads. Engineered using the most sophisticated technology, it represents a key element in the artisans' workshop. Create classic raised panels on furniture, interior and cabinet doors on solid wood and wooden boards, and achieve three different profiles by adjusting the cutting depth. We recommend multiple passes for safe and accurate finishing. **For use on spindle moulders, moulders, and double-end tenoners.** Perfect for all materials, but ideal on hard wood and panels.

TECHNICAL DETAILS:

- Hard aluminium alloy body with high resistance to tensile and yield stress.
- 2 HWM Knives type **(A)** 19,8x11,9x1,5mm [Z2].
- 2 HWM Knives type **(B)** 60x11,9x1,5mm [Z2].
- Tools for manual feed (MAN).
- Pins for the automatic positioning of the knives.

SAFETY TIPS:



The **TW-006** Torque Screwdriver is recommended for the proper fastening of screws (see page 406).



Supplied in a sturdy plastic carry case

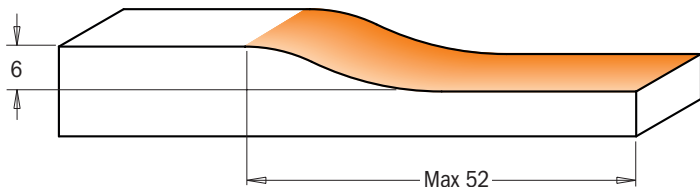
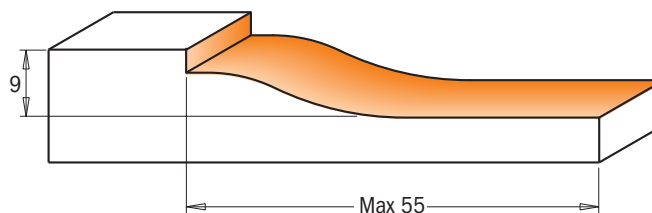
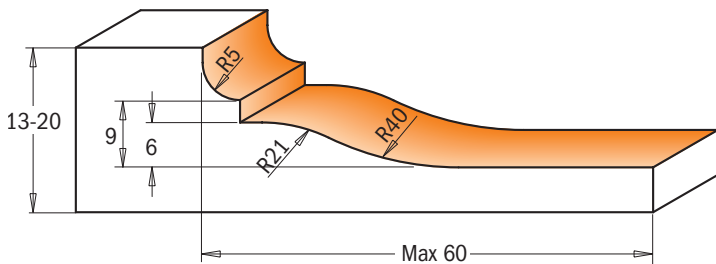
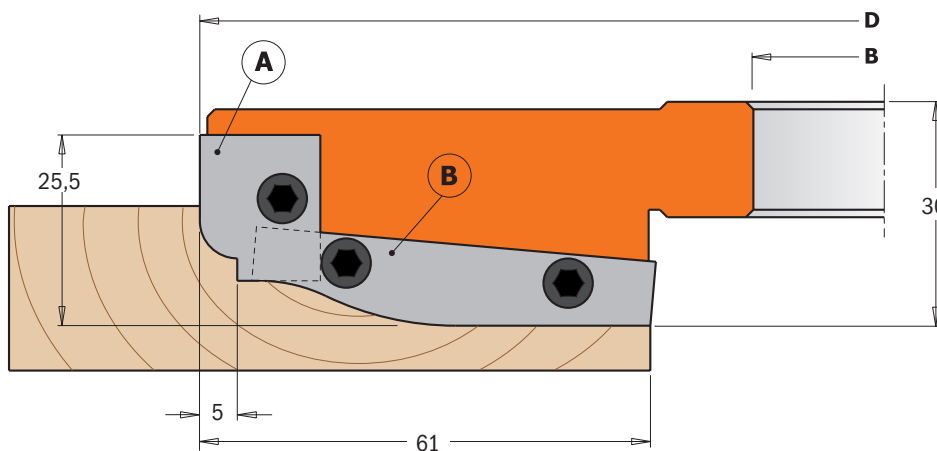

Drawing is 1:1 scale

D mm	B mm	Z	RPM		ORDER NO.
183	30	2+2	4100~7000	1	694.013.30
183	31,75	2+2	4100~7000	1	694.013.31
183	35	2+2	4100~7000	1	694.013.35
200	40	2+2	3800~6400	1	694.013.40
200	50	2+2	3800~6400	1	694.013.50

Spare parts

x2	16x11x9,5mm	x2	53x11x9,5mm	
695.013.A1	695.999.16	695.013.A2	695.999.53	990.066.00
695.013.A1	695.999.16	695.013.A2	695.999.53	990.066.00
695.013.A1	695.999.16	695.013.A2	695.999.53	990.066.00
695.013.A1	695.999.16	695.013.A2	695.999.53	990.066.00
695.013.A1	695.999.16	695.013.A2	695.999.53	990.066.00

Spare parts: **991.083.00** 3x90x135mm hex key

Profile & Counter Profile Cutter Head Sets



694.015

These versatile sets were designed to make furniture and doors on soft and hardwood. It allows the insertion of five different knives to produce the most popular and classical profiles. The adjustable cutter, included in the set, can also be used individually to carry out grooves between 8mm 15mm. For use on spindle moulders and moulder machines. Perfect on hard wood and panels maximum 22 - 25mm in thickness.



Supplied in a sturdy plastic carry case

TECHNICAL DETAILS:

- Hard aluminium alloy body with high resistance to tensile and yield stress for cutter heads (1 & 2).
- Super-strength steel body for cutter head (3).
- 2 HWM knives type (A1) 25x29,8x2mm [Z2].
- 2 HWM knives type (A2) 25x29,8x2mm [Z2].
- 4 HWM knives 7,65x12x1,5mm [Z4].
- 4 HWM knives 14x14x2m for heads type (1 & 2).
- 12 spacer rings from 0,1 to 3mm for heads type (1 & 2).
- 12 spacer rings from 0,1 to 2mm for heads type (3).
- Tools for manual feed (MAN).
- Pins for the automatic positioning of the knives.

SAFETY TIPS:



The **TW-006** Torque Screwdriver is recommended for the proper fastening of screws (see page 406).

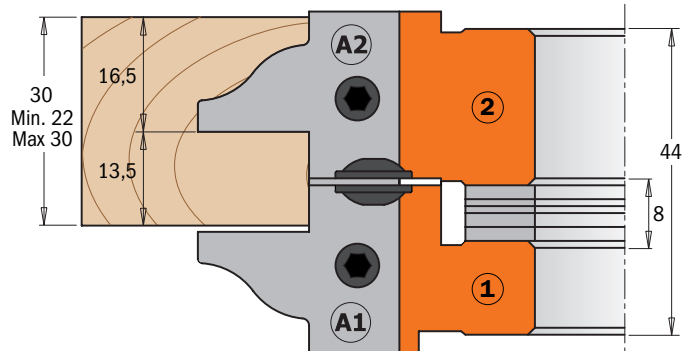
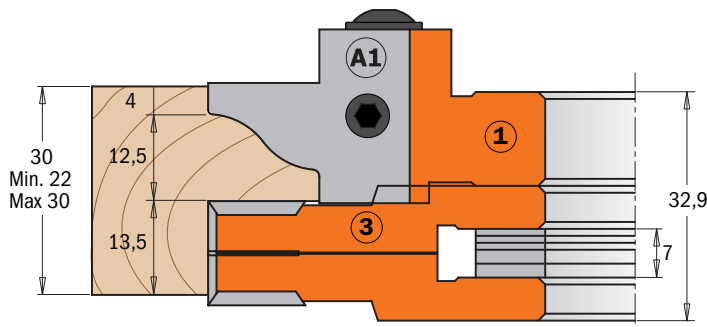
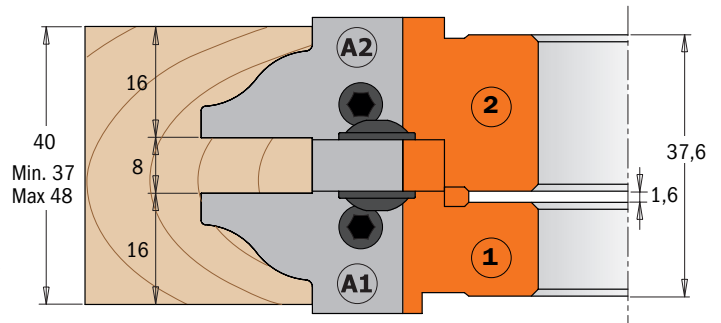
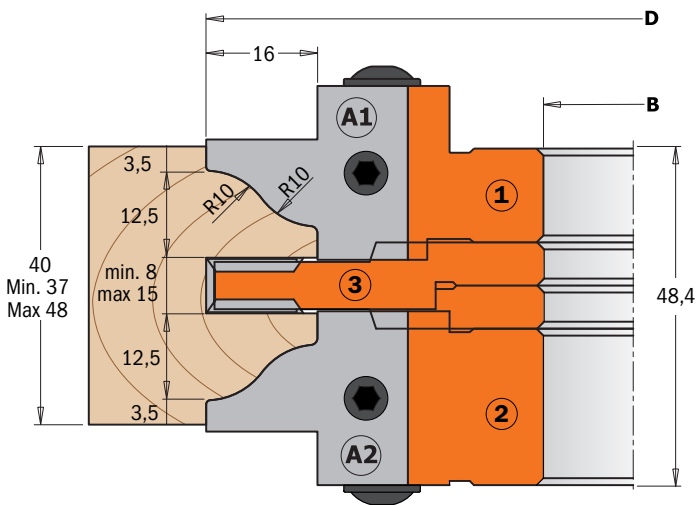

D mm	B mm	Z+V	RPM		ORDER NO.
132	30	2+4	5700~9500	1	694.015.30
132	31,75	2+4	5700~9500	1	694.015.31
132	35	2+4	5700~9500	1	694.015.35
147	40	2+4	5100~8500	1	694.015.40
147	50	2+4	5100~8500	1	694.015.50

Spare parts

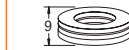

695.998.01

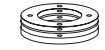

695.998.21

Optional



695.998.30

695.998.02

695.998.22

695.998.31

695.998.03

695.998.23

695.998.35

695.998.04

695.998.06

695.998.40

695.998.05

695.998.07

Spare parts:

Head type (1)

- 695.015.A1 25x29,8x2mm HWM pair of knives (A1)
- 695.015.B1 25x29,8x2mm HWM pair of knives (B1)
- 695.015.C1 25x29,8x2mm HWM pair of knives (C1)
- 695.015.D1 25x29,8x2mm HWM pair of knives (D1)
- 695.015.E1 25x29,8x2mm HWM pair of knives (E1)
- 695.999.23 23x11x9,5mm wedge for knives
- 990.066.00 M6x16mm screw
- 991.067.00 3mm hex key

Head type (2)

- 695.015.A2 25x29,8x2mm HWM pair of knives (A2)
- 695.015.B2 25x29,8x2mm HWM pair of knives (B2)
- 695.015.C2 25x29,8x2mm HWM pair of knives (C2)
- 695.015.D2 25x29,8x2mm HWM pair of knives (D2)
- 695.015.E2 25x29,8x2mm HWM pair of knives (E2)
- 695.999.24 23x11x9,5mm wedge for knives
- 990.066.00 M6x16mm screws
- 991.067.00 3mm hex key

Head type (3)

- 790.076.00* 7,65x12x1,5mm HWM knives
- 695.999.07 6,8x11x9,5mm wedge for knives
- 990.063.00 M5x18mm screw
- 991.072.00 T20 hex key
- 790.140.00* 14x14x2mm HWM Knives
- 990.080.00 M5x6,5mm screw
- 991.073.00 T25 hex key

*Minimum 10 pieces or multiple

Standard

Pair of knives **695.015.A1** - Pair of knives **695.015.A2**

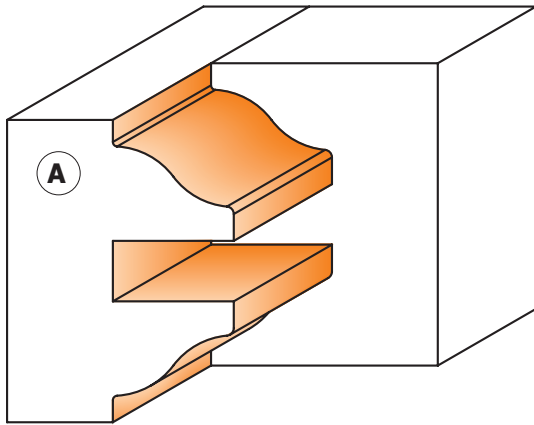

Drawing is 1:1 scale

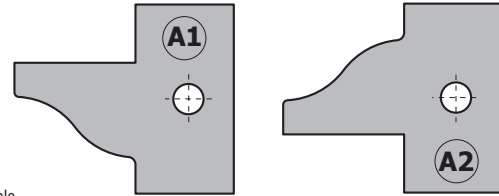

Optional

Pair of knives **695.015.B1**
Pair of knives **695.015.B2**

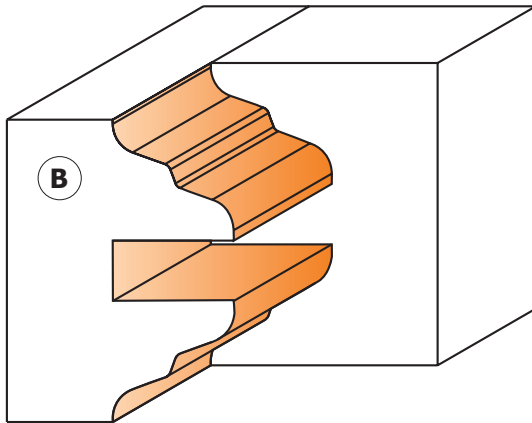
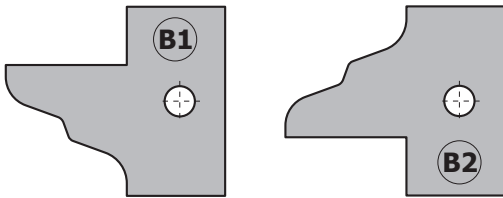

Pair of knives **695.015.C1**
Pair of knives **695.015.C2**

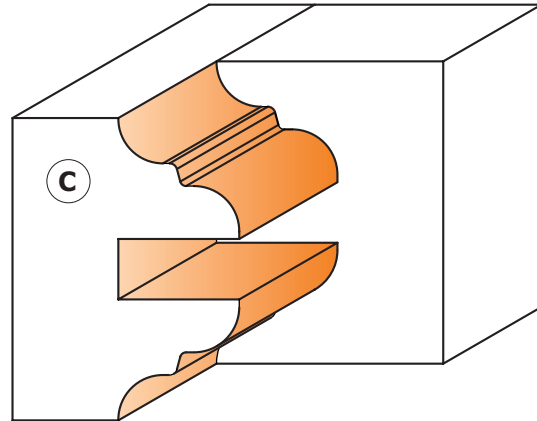
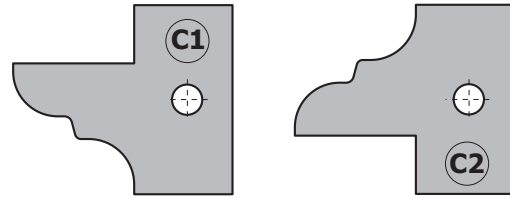

Pair of knives **695.015.D1**
Pair of knives **695.015.D2**

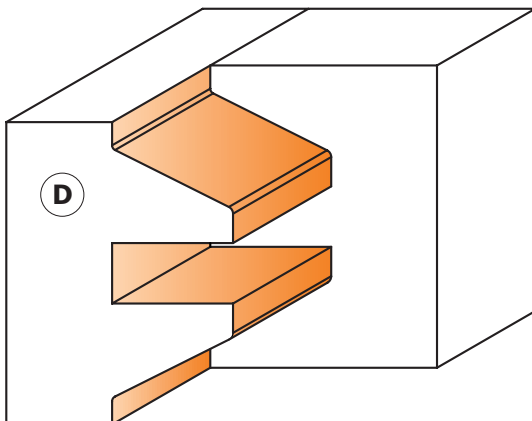
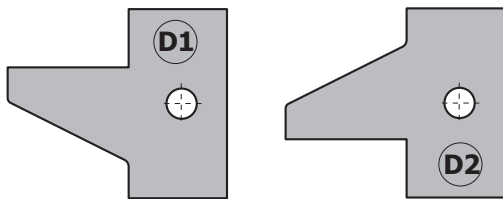

Pair of knives **695.015.E1**
Pair of knives **695.015.E2**

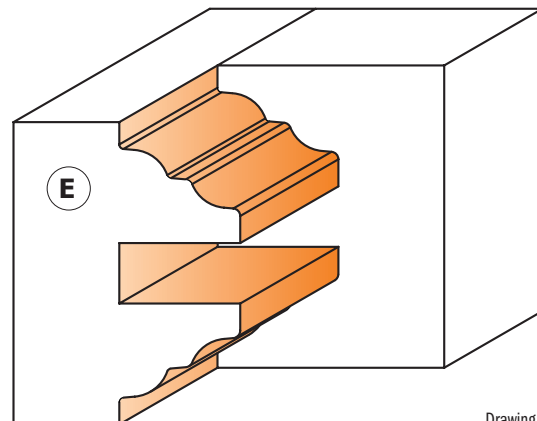
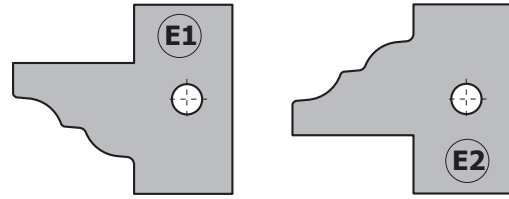

Drawing is 1:1 scale

1-Piece Rail & Stile Cutter Heads

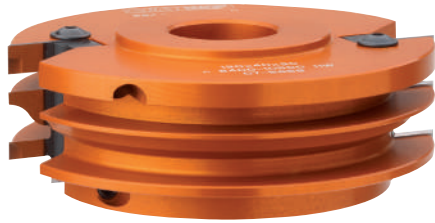

694.014

These are unique products made by combining two cutter heads, ideal for making furniture doors and drawers. By adjusting the height of the of the cutter head, you can cut two perfectly fitted profiles without wasting time or effort on the fence or replacing the tool. Improve your efficiency and save money only having to purchase one single cutter head!!! For use on spindle moulders. Perfect on hardwood and panels between 22mm-25mm in thickness.



TECHNICAL DETAILS:

- Hard aluminium alloy body with high resistance to tensile and yield stress.
- 2 HWM knives type (A) 40x24,5x2mm [Z2].
- Tools for manual feed (MAN).
- Pins for the automatic positioning of the knives.



SAFETY TIPS:



The **TW-006** Torque Screwdriver is recommended for the proper fastening of screws (see page 406).

Supplied in a sturdy plastic carry case

Standard

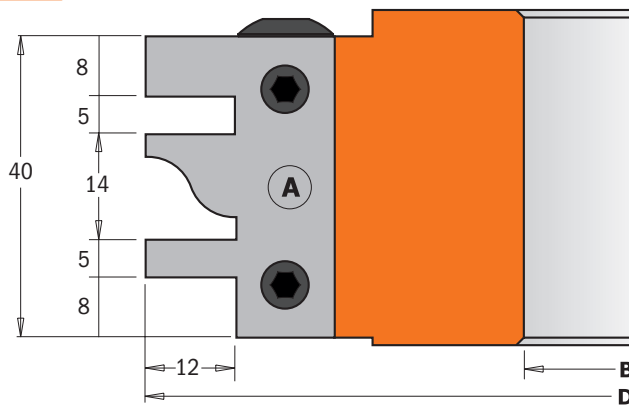

Pair of knives 695.014A

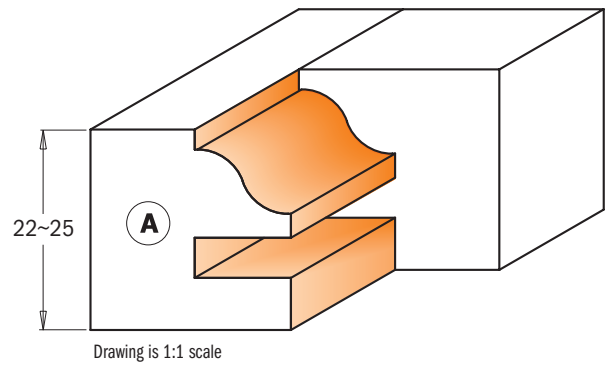

Optional

Pair of knives 695.014B

Pair of knives 695.014C

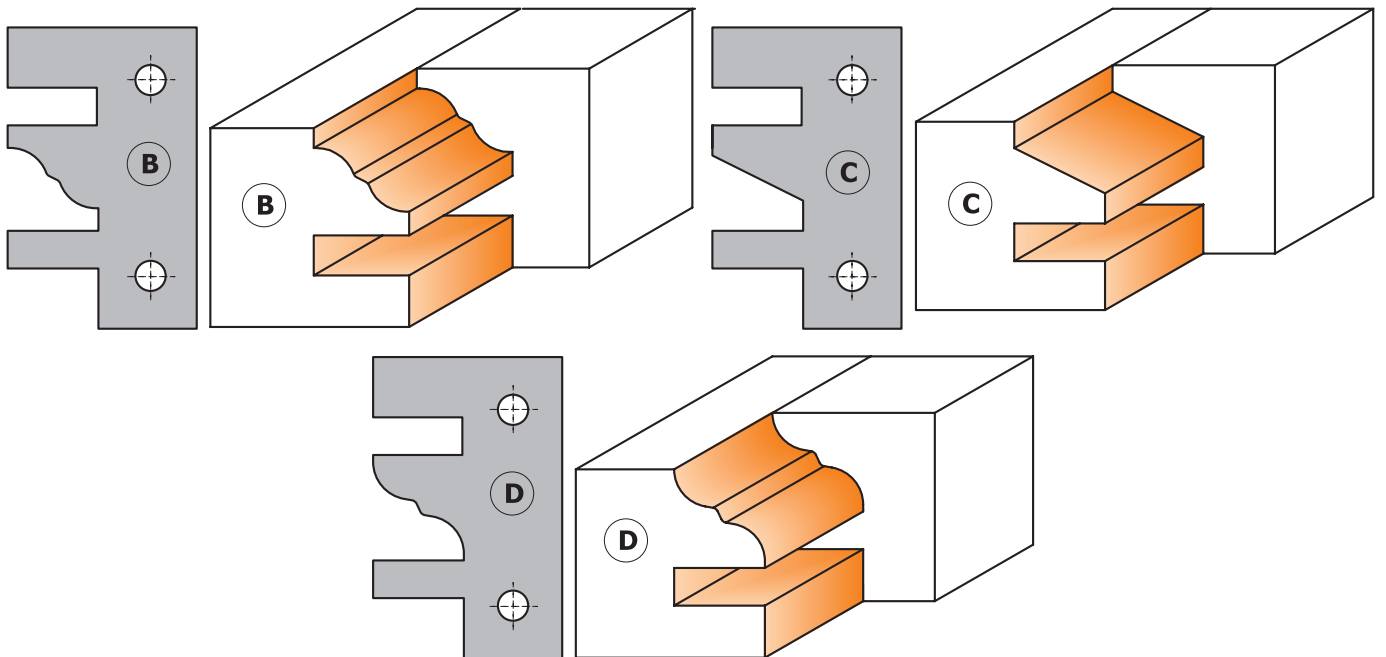

Pair of knives 695.014D

Drawing is 1:1 scale

D mm	B mm	Z	RPM		ORDER NO.
120	30	2	6400~10500	1	694.014.30
120	31,75	2	6400~10500	1	694.014.31
120	35	2	6400~10500	1	694.014.35
120	40	2	6400~10500	1	694.014.40
130	50	2	6400~10500	1	694.014.50

Spare parts

695.014A x2	695.999.39	990.066.00	991.067.00
695.014A	695.999.39	990.066.00	991.067.00
695.014A	695.999.39	990.066.00	991.067.00
695.014A	695.999.39	990.066.00	991.067.00
695.014A	695.999.39	990.066.00	991.067.00

Optional: **695.014B** 40x24,5x2mm pair of knives type (B)
695.014C 40x24,5x2mm pair of knives type (C)
695.014D 40x24,5x2mm pair of knives type (D)

Cutter Heads without Limiters



692

CMT cutter heads guarantee excellent performance for all your projects. For use on all types of moulder and spindle moulder machines, profiler and edging machines.

TECHNICAL DETAILS:

- Hard aluminium or steel alloy cutter head without limiters, highly resistant to tensile and yield stress.
- Pair of universal straight knives included.
- Tools for mechanical feed (MEC).
- Pins for the automatic positioning of the knives.
- Possibility to use knives with a height of 40mm or 50mm (order no. 690).

SAFETY TIPS:



The **TW-006** Torque Screwdriver is recommended for the proper fastening of screws (see page 406).

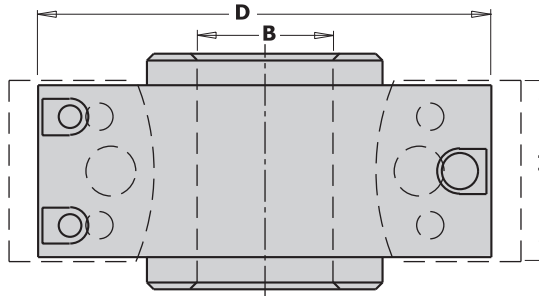
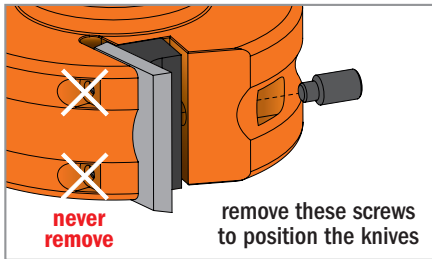

Supplied in a sturdy plastic carry case. Contains 12 pairs of knives.

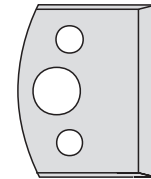

690.000

D mm	I mm	B mm	RPM		ORDER NO. Steel body	ORDER NO. Aluminium body
78	40	19,05	7000~9000	1		692.078.19*
78	40	30	7000~9000	1		692.078.30*
100	40-50	25,4	5500~8400	1		692.100.26
100	40-50	30	5500~8400	1	692.101.30	692.100.30
100	40-50	31,75	5500~8400	1		692.100.31
100	40-50	35	5500~8400	1	692.101.35	692.100.35
120	40-50	50	4800~7400	1	692.121.50	692.120.50

Spare parts

692.999.01	990.064.00	991.064.00
692.999.01	990.064.00	991.064.00
692.999.01	990.064.00	991.064.00
692.999.01	990.064.00	991.064.00
692.999.01	990.064.00	991.064.00
692.999.01	990.064.00	991.064.00
692.999.01	990.064.00	991.064.00
692.999.01	990.064.00	991.064.00

*For safety reasons we recommend the use of knives with a 40mm height only.

Cutter Heads with Limiters



693

CMT cutter heads guarantee excellent performance for all your projects. For use on all types of moulder and spindle moulder machines and moulder machines.

TECHNICAL DETAILS:

- Hard aluminium or steel alloy cutter head with limiters, highly resistant to tensile and yield stress.
- Pair of universal straight knives and limiters included.
- Tools for manual feed (MAN).
- Pins for the automatic positioning of the knives.
- Possibility to use knives with a height of 40mm or 50mm (order no. 690) and limiters (order no. 691).

Made in compliance with EU Directive EN 847-1.

SAFETY TIPS:



The **TW-006** Torque Screwdriver is recommended for the proper fastening of screws (see page 406).

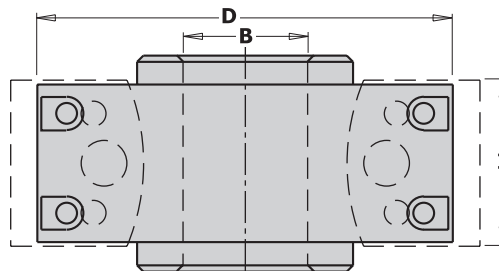
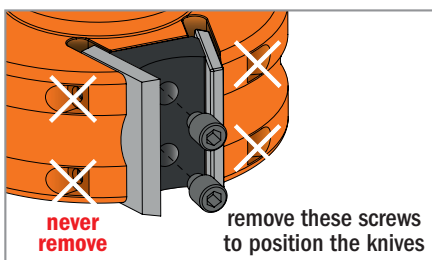

Supplied in a sturdy plastic carry case. Contains 12 pairs of knives.

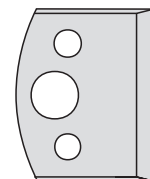

690.000

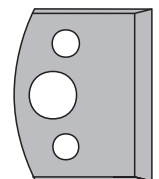

691.000

D mm	I mm	B mm	RPM		ORDER NO. Steel body	ORDER NO. Aluminium body
78	40	30	7000~9000	1	693.078.30	
100	40-50	30	5500~8400	1	693.101.30	693.100.30
100	40-50	31,75	5500~8400	1		693.100.31
100	40-50	35	5500~8400	1	693.101.35	693.100.35
120	40-50	50	4800~7400	1	693.121.50	693.120.50

Spare parts

693.999.01	990.065.00	991.064.00
693.999.01	990.065.00	991.064.00
693.999.01	990.065.00	991.064.00
693.999.01	990.065.00	991.064.00
693.999.01	990.065.00	991.064.00
693.999.01	990.065.00	991.064.00

13-Piece Multiprofile Cutter Head Sets without Limiters



692

This set is ideal for making joints and frames and include 3 essential profiles specifically for creating cabinet doors. An invaluable asset for any professional woodworker. The cutter heads included allow the insertion of knives at a height of either 40mm or 50mm. Both cutter head and knives are packaged in a sturdy plastic case to prevent damage.

These sets include:

- 1 cutter head in hard aluminium alloy with pins for the automatic positioning of the knives.
- 13 pairs of knives with a cutting height of 40mm

SAFETY TIPS:

The **TW-006** Torque Screwdriver is recommended for the proper fastening of screws (see page 406).

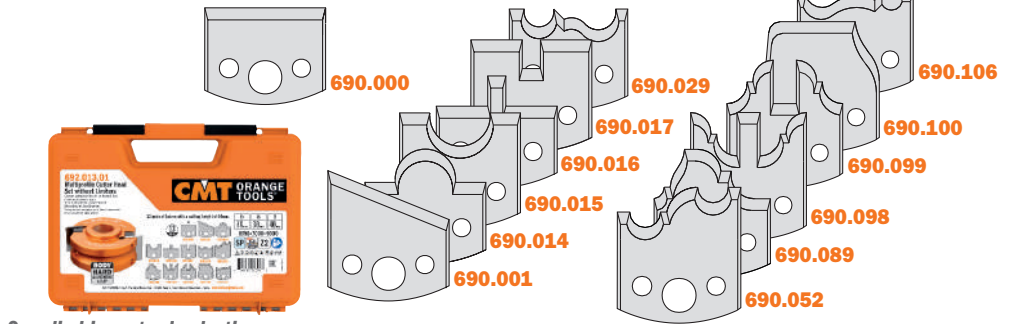
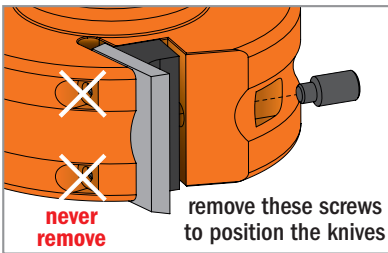

Supplied in a sturdy plastic carry case

D mm	I mm	B mm	RPM		ORDER NO.
78	40	19,05	5500~8400	1	692.013.09
78	40	30	5500~8400	1	692.013.01
100	40	25,4	5500~8400	1	692.013.10
100	40	30	5500~8400	1	692.013.02
100	40	31,75	5500~8400	1	692.013.11
100	40	35	5500~8400	1	692.013.03
120	40	50	5500~8400	1	692.013.04

Spare parts

692.999.01	990.064.00	991.064.00
692.999.01	990.064.00	991.064.00
692.999.01	990.064.00	991.064.00
692.999.01	990.064.00	991.064.00
692.999.01	990.064.00	991.064.00
692.999.01	990.064.00	991.064.00
692.999.01	990.064.00	991.064.00
692.999.01	990.064.00	991.064.00



692

13 of the most popular profiles combined in one sturdy carry case. The featured cutter head fits 40-50mm knives.

These sets include:

- 1 cutter head in hard aluminium alloy with pins for the automatic positioning of the knives.
- 13 pairs of knives with a cutting height of 40mm.

SAFETY TIPS:

The **TW-006** Torque Screwdriver is recommended for the proper fastening of screws (see page 406).

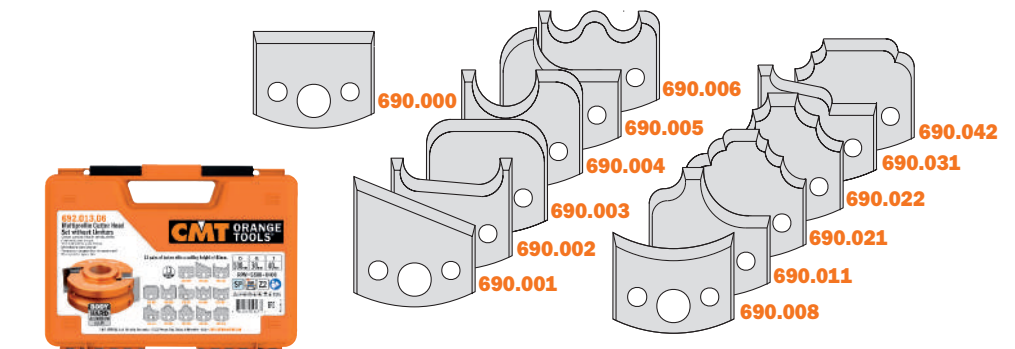
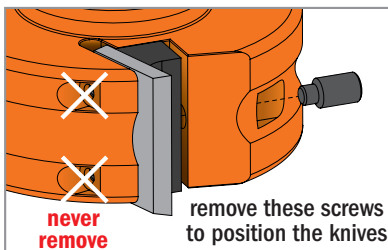

Supplied in a sturdy plastic carry case

D mm	I mm	B mm	RPM		ORDER NO.
78	40	19,05	5500~8400	1	692.013.12
78	40	30	5500~8400	1	692.013.05
100	40	25,4	5500~8400	1	692.013.13
100	40	30	5500~8400	1	692.013.06
100	40	31,75	5500~8400	1	692.013.14
100	40	35	5500~8400	1	692.013.07
120	40	50	5500~8400	1	692.013.08

Spare parts

692.999.01	990.064.00	991.064.00
692.999.01	990.064.00	991.064.00
692.999.01	990.064.00	991.064.00
692.999.01	990.064.00	991.064.00
692.999.01	990.064.00	991.064.00
692.999.01	990.064.00	991.064.00
692.999.01	990.064.00	991.064.00
692.999.01	990.064.00	991.064.00

7-Piece Multiprofile Cutter Head Sets with Limiters



693

CMT has assembled 7 profiles in this convenient set for the professional woodworker; perfect for creating kitchen cabinet doors with a horizontal profile and featuring two pairs of cutters for male-female joints. A specially designed cutter head allows the insertion of knives with a height of either 40mm or 50mm. The cutter head also boasts safety limiters in keeping with European standards EN 847-1.

These sets include:

- 1 cutter head in hard aluminium alloy allowing the insertion of straight knives, limiters and pins for the automatic positioning of the knives.
- 7 pairs of 40mm knives, as per illustration.
- 7 pairs of relative limiters.

SAFETY TIPS:



The **TW-006** Torque Screwdriver is recommended for the proper fastening of screws (see page 406).



Supplied in a sturdy plastic carry case

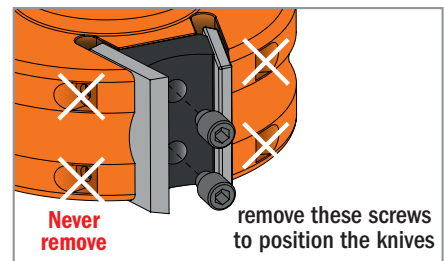
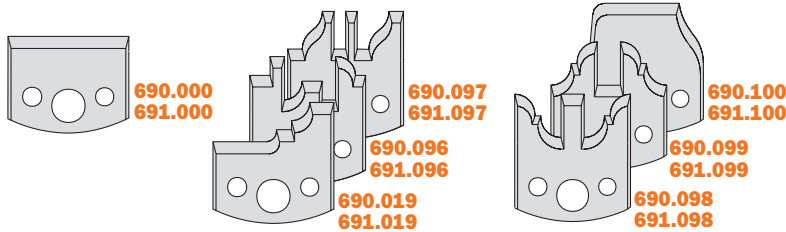

D mm	I mm	B mm	RPM		ORDER NO.
100	40	30	5500~8400	1	693.013.01
100	40	35	5500~8400	1	693.013.02
120	40	50	5500~8400	1	693.013.03

Spare parts

693.999.01	990.065.00	991.064.00
693.999.01	990.065.00	991.064.00
693.999.01	990.065.00	991.064.00

7-Piece Multiprofile Cutter Head Sets with Limiters



693

CMT has assembled the 7 most popular profiles in this practical set conveniently packaged in a sturdy protective carry case. The specially designed cutter head allows the insertion of knives with a height of either 40mm or 50mm. The cutter head also boasts safety limiters in keeping with European standards EN 847-1.

These sets include:

- 1 cutter head in hard aluminium alloy allowing the insertion of straight knives, with limiters and pins for the automatic positioning of the knives.
- 7 pairs of 40mm knives, as per illustration.
- 7 pairs of relative limiters.

SAFETY TIPS:



The **TW-006** Torque Screwdriver is recommended for the proper fastening of screws (see page 406).



Supplied in a sturdy plastic carry case

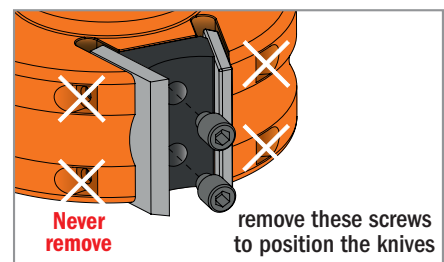
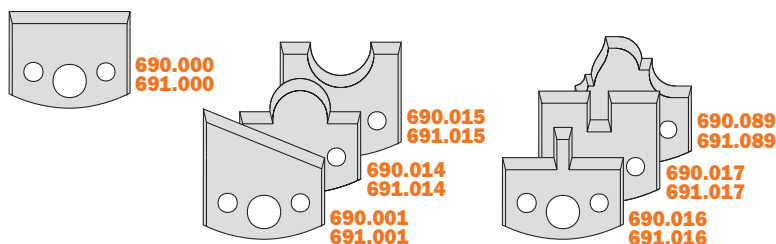

D mm	I mm	B mm	RPM		ORDER NO.
100	40	30	5500~8400	1	693.013.04
100	40	35	5500~8400	1	693.013.05
120	40	50	5500~8400	1	693.013.06

Spare parts

693.999.01	990.065.00	991.064.00
693.999.01	990.065.00	991.064.00
693.999.01	990.065.00	991.064.00

Profile Knives and Limiters

Cutting Length=40mm

Thickness=4mm

Pack Qty. 10

SP

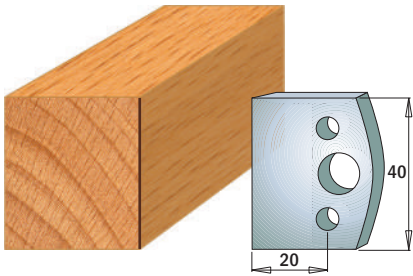

Pair of knives **690.000**
Pair of limiters **691.000**

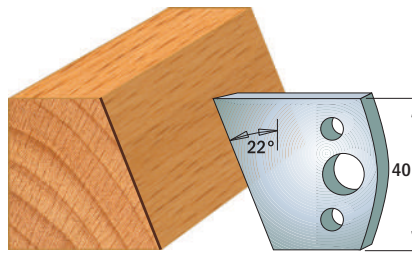

Pair of knives **690.001**
Pair of limiters **691.001**

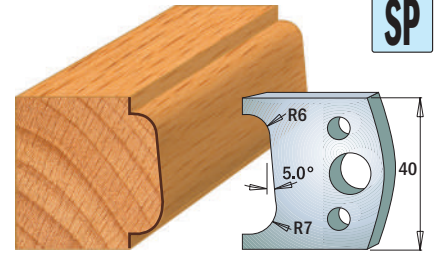

Pair of knives **690.002**
Pair of limiters **691.002**

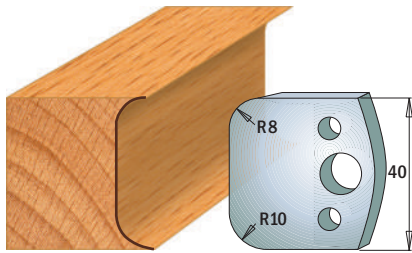

Pair of knives **690.003**
Pair of limiters **691.003**

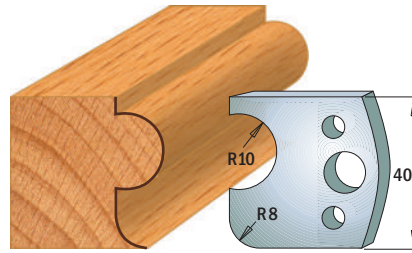

Pair of knives **690.004**
Pair of limiters **691.004**

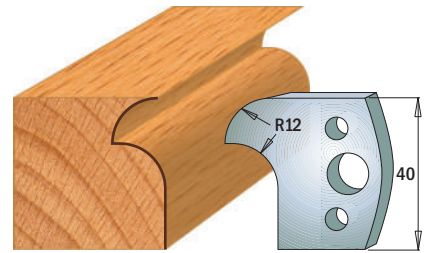

Pair of knives **690.005**
Pair of limiters **691.005**

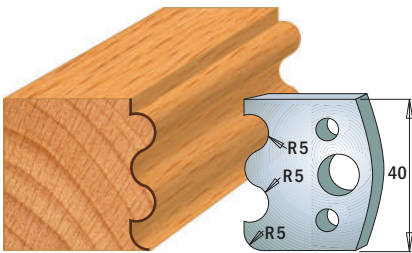

Pair of knives **690.006**
Pair of limiters **691.006**

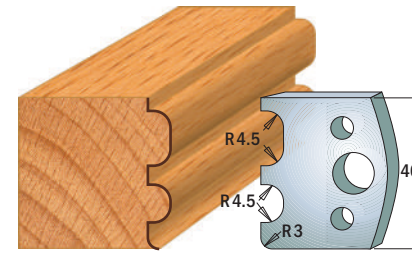

Pair of knives **690.007**
Pair of limiters **691.007**

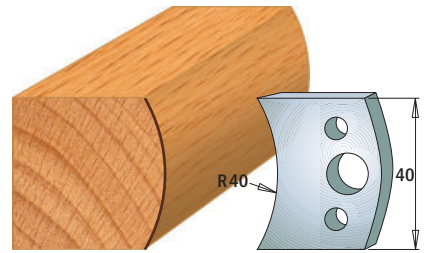

Pair of knives **690.008**
Pair of limiters **691.008**

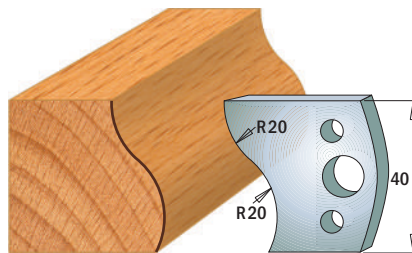

Pair of knives **690.009**
Pair of limiters **691.009**

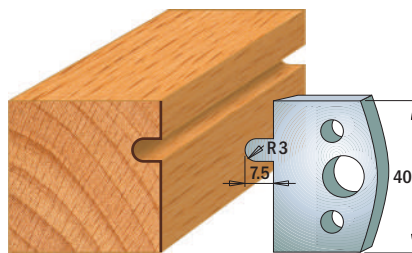

Pair of knives **690.010**
Pair of limiters **691.010**

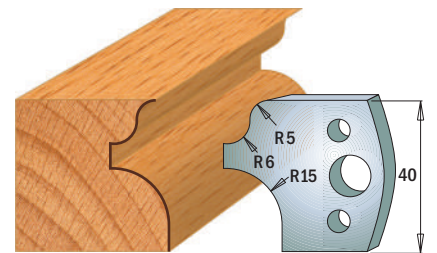

Pair of knives **690.011**
Pair of limiters **691.011**

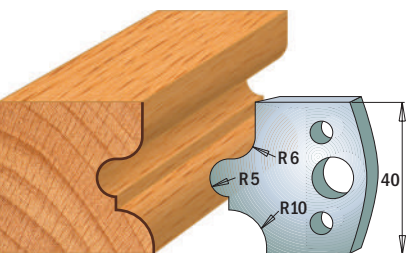

Pair of knives **690.012**
Pair of limiters **691.012**

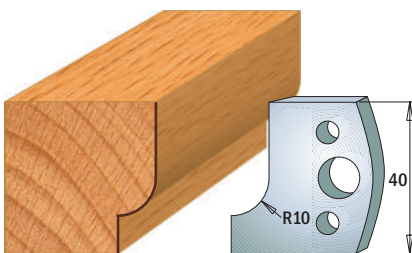

Pair of knives **690.013**
Pair of limiters **691.013**

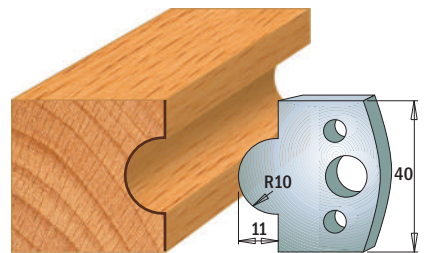

Pair of knives **690.014**
Pair of limiters **691.014**

NOTE: all knives & limiters available only in pairs.
Drawings are 1:2 scale
Dimensions in mm.

Profile Knives and Limiters

Cutting Length=40mm Thickness=4mm

Pack Qty. 10



SP

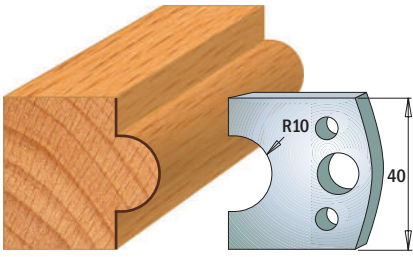

Pair of knives **690.015**
Pair of limiters **691.015**

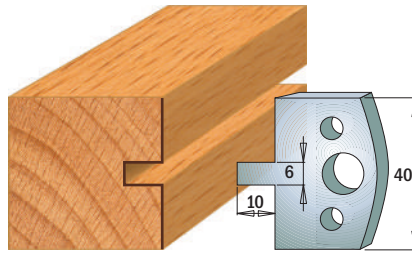

Pair of knives **690.016**
Pair of limiters **691.016**

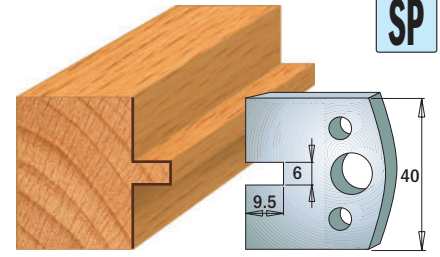

Pair of knives **690.017**
Pair of limiters **691.017**

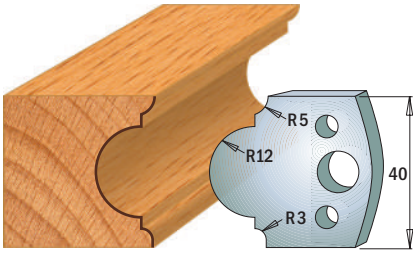

Pair of knives **690.018**
Pair of limiters **691.018**

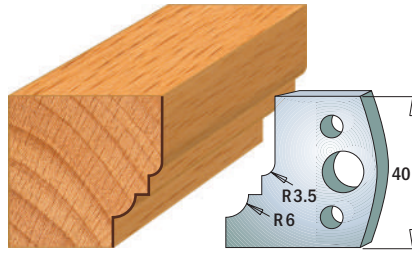

Pair of knives **690.019**
Pair of limiters **691.019**

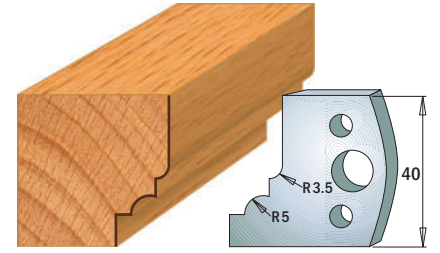

Pair of knives **690.020**
Pair of limiters **691.020**

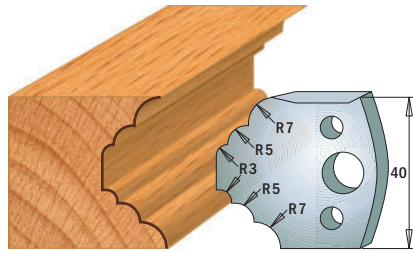

Pair of knives **690.021**
Pair of limiters **691.021**

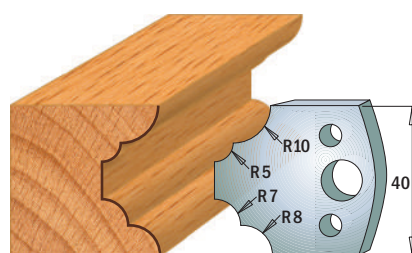

Pair of knives **690.022**
Pair of limiters **691.022**

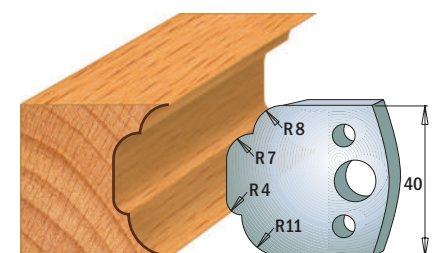

Pair of knives **690.023**
Pair of limiters **691.023**

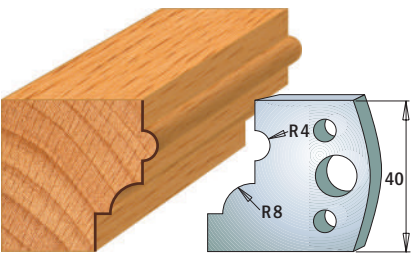

Pair of knives **690.024**
Pair of limiters **691.024**

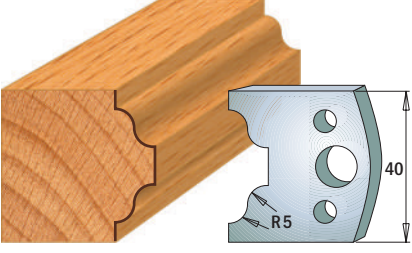

Pair of knives **690.025**
Pair of limiters **691.025**

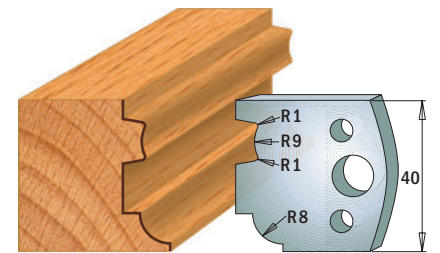

Pair of knives **690.026**
Pair of limiters **691.026**

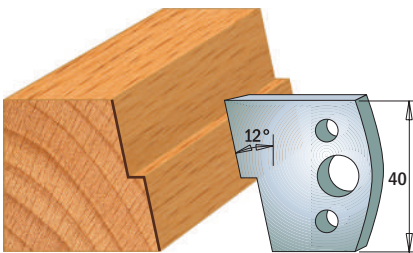

Pair of knives **690.027**
Pair of limiters **691.027**

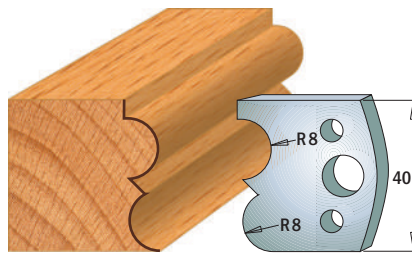

Pair of knives **690.028**
Pair of limiters **691.028**

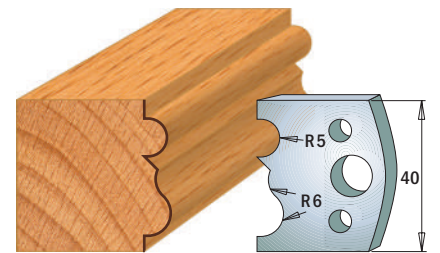

Pair of knives **690.029**
Pair of limiters **691.029**

NOTE: all knives & limiters available only in pairs.
Drawings are 1:2 scale
Dimensions in mm.

Profile Knives and Limiters

Cutting Length=40mm

Thickness=4mm

Pack Qty. 10

SP

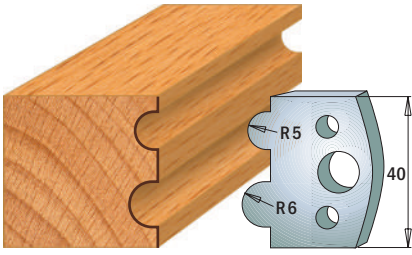

Pair of knives **690.030**
Pair of limiters **691.030**

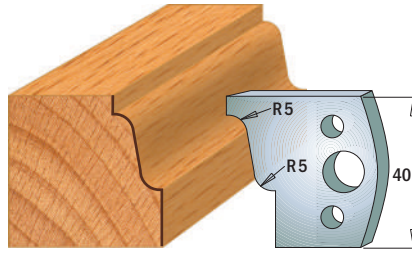

Pair of knives **690.031**
Pair of limiters **691.031**

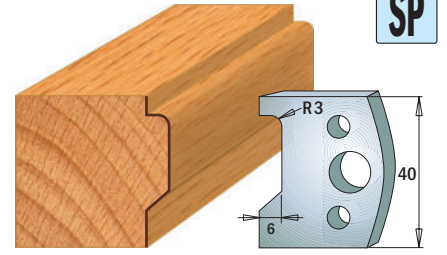

Pair of knives **690.032**
Pair of limiters **691.032**

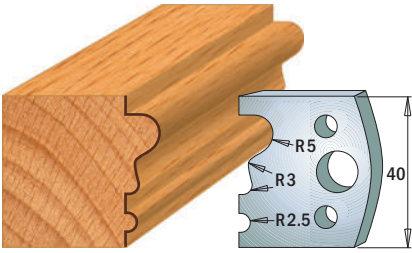

Pair of knives **690.033**
Pair of limiters **691.033**

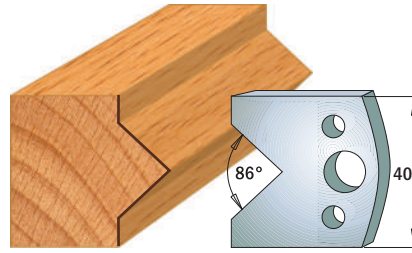

Pair of knives **690.034**
Pair of limiters **691.034**

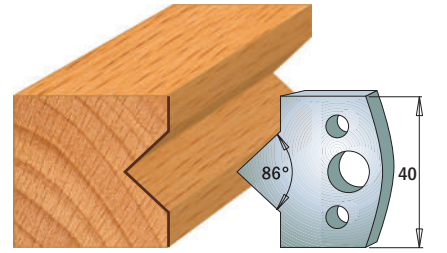

Pair of knives **690.035**
Pair of limiters **691.035**

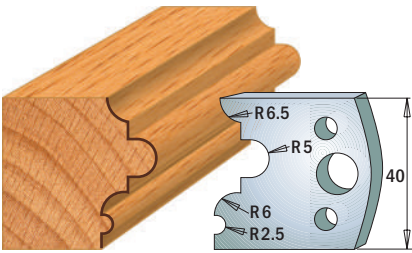

Pair of knives **690.036**
Pair of limiters **691.036**

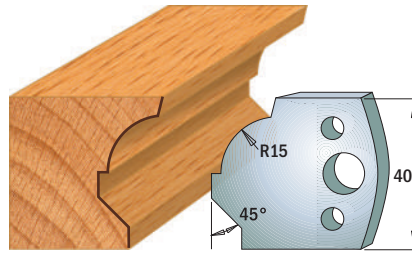

Pair of knives **690.037**
Pair of limiters **691.037**

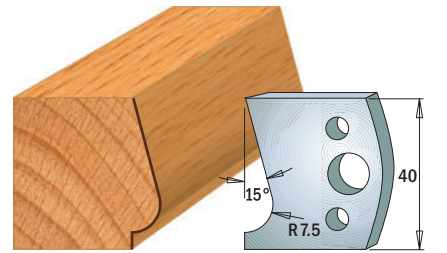

Pair of knives **690.038**
Pair of limiters **691.038**

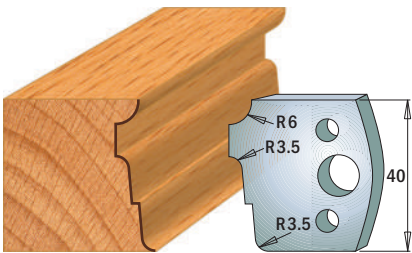

Pair of knives **690.039**
Pair of limiters **691.039**

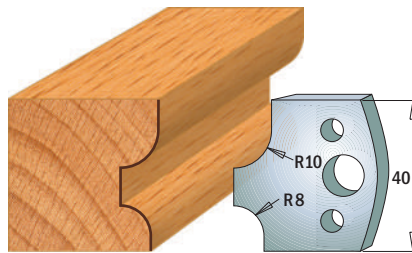

Pair of knives **690.040**
Pair of limiters **691.040**

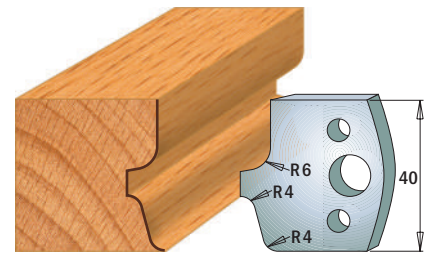

Pair of knives **690.041**
Pair of limiters **691.041**

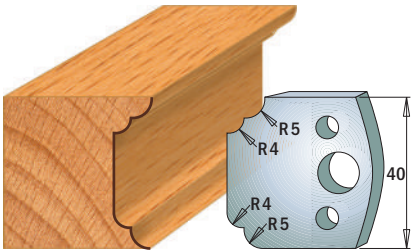

Pair of knives **690.042**
Pair of limiters **691.042**

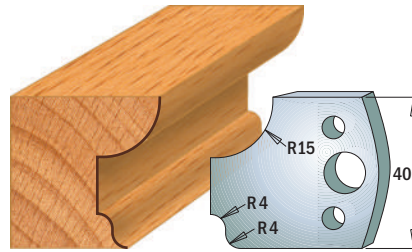

Pair of knives **690.043**
Pair of limiters **691.043**

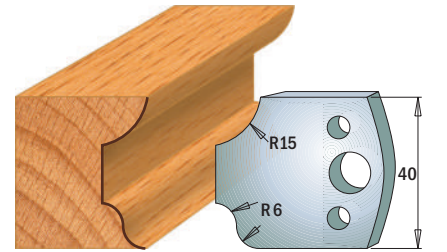

Pair of knives **690.044**
Pair of limiters **691.044**

NOTE: all knives & limiters available only in pairs.
Drawings are 1:2 scale. Dimensions in mm.

Profile Knives and Limiters

Cutting Length=40mm Thickness=4mm

Pack Qty. 10



SP

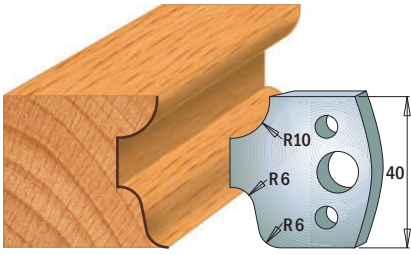

Pair of knives **690.045**
Pair of limiters **691.045**

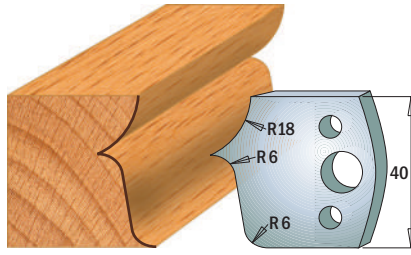

Pair of knives **690.046**
Pair of limiters **691.046**

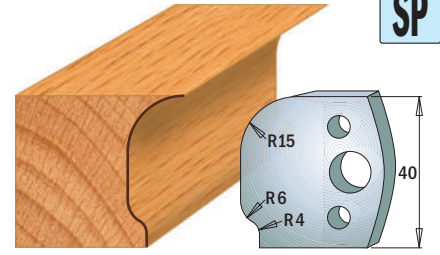

Pair of knives **690.047**
Pair of limiters **691.047**

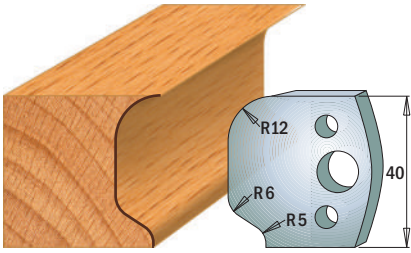

Pair of knives **690.048**
Pair of limiters **691.048**

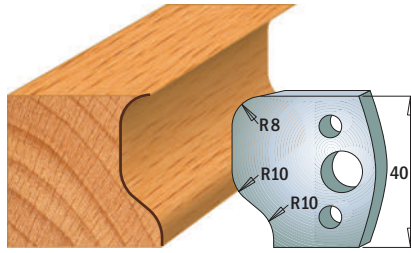

Pair of knives **690.049**
Pair of limiters **691.049**

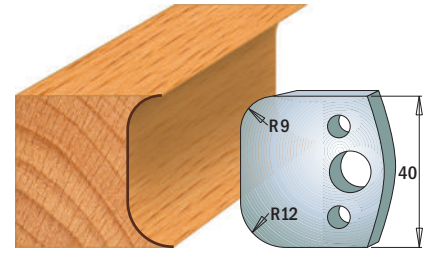

Pair of knives **690.050**
Pair of limiters **691.050**

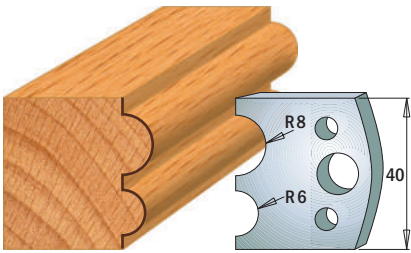

Pair of knives **690.051**
Pair of limiters **691.051**

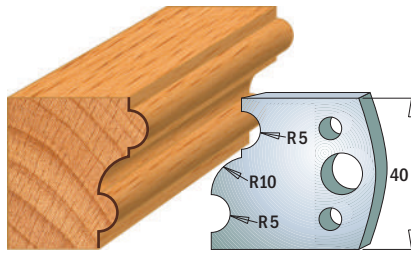

Pair of knives **690.052**
Pair of limiters **691.052**

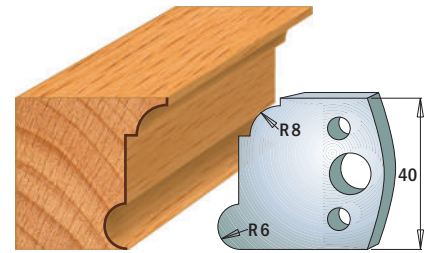

Pair of knives **690.053**
Pair of limiters **691.053**

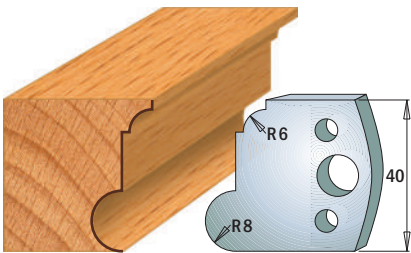

Pair of knives **690.054**
Pair of limiters **691.054**

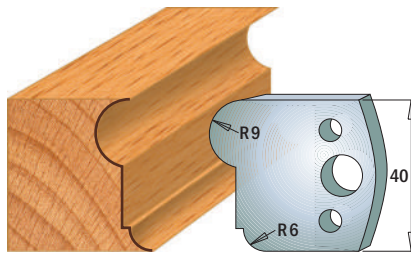

Pair of knives **690.055**
Pair of limiters **691.055**

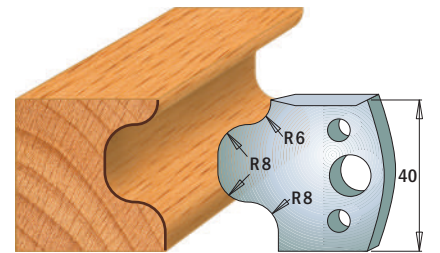

Pair of knives **690.056**
Pair of limiters **691.056**

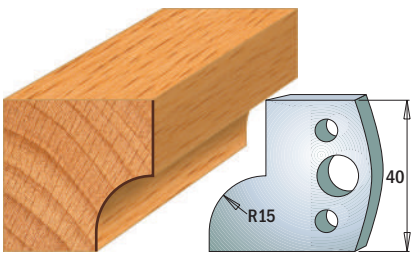

Pair of knives **690.057**
Pair of limiters **691.057**

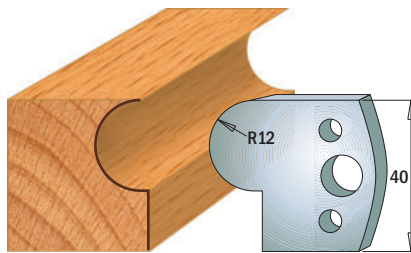

Pair of knives **690.058**
Pair of limiters **691.058**

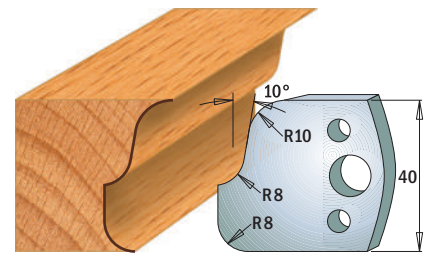

Pair of knives **690.059**
Pair of limiters **691.059**

NOTE: all knives & limiters available only in pairs.
Drawings are 1:2 scale. Dimensions in mm.

Profile Knives and Limiters

Cutting Length=40mm

Thickness=4mm

Pack Qty. 10

SP

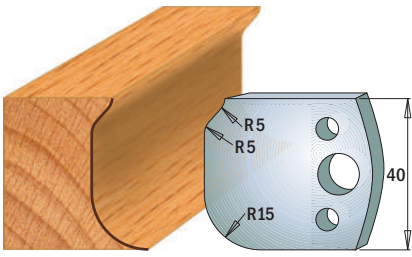

Pair of knives **690.060**
Pair of limiters **691.060**

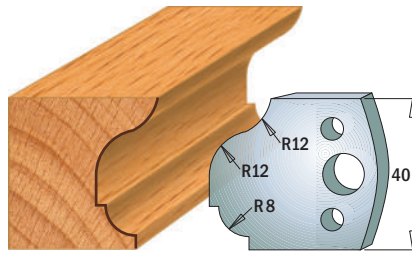

Pair of knives **690.061**
Pair of limiters **691.061**

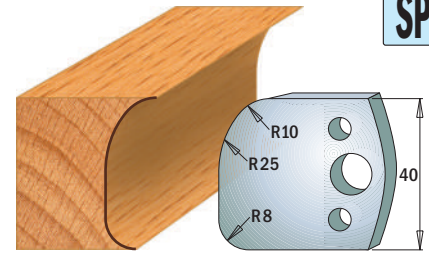

Pair of knives **690.062**
Pair of limiters **691.062**

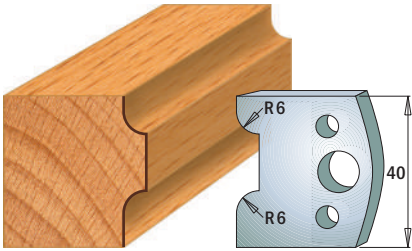

Pair of knives **690.063**
Pair of limiters **691.063**

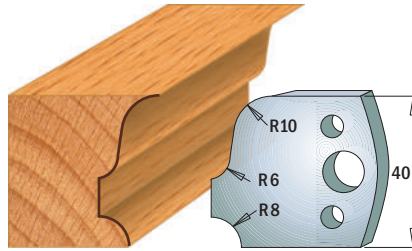

Pair of knives **690.064**
Pair of limiters **691.064**

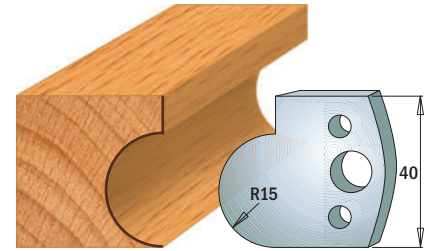

Pair of knives **690.065**
Pair of limiters **691.065**

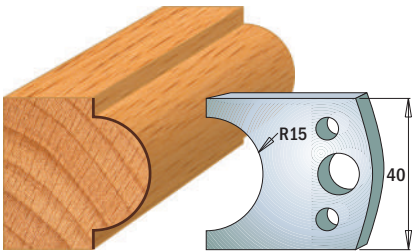

Pair of knives **690.066**
Pair of limiters **691.066**

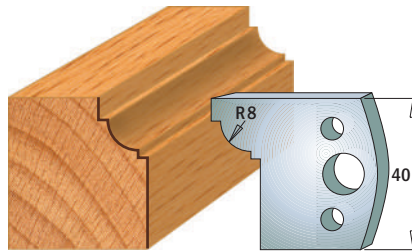

Pair of knives **690.067**
Pair of limiters **691.067**

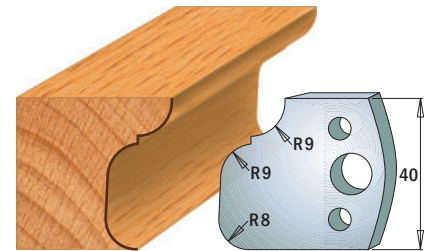

Pair of knives **690.068**
Pair of limiters **691.068**

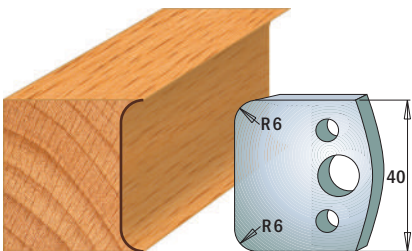

Pair of knives **690.069**
Pair of limiters **691.069**

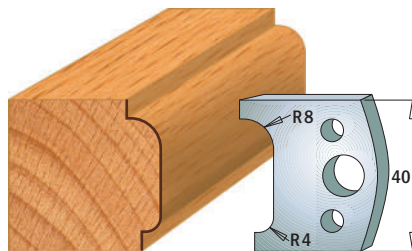

Pair of knives **690.070**
Pair of limiters **691.070**

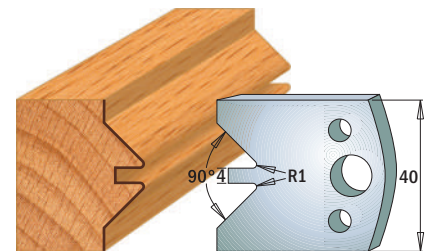

Pair of knives **690.071**
Pair of limiters **691.071**

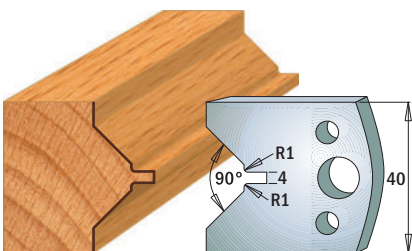

Pair of knives **690.072**
Pair of limiters **691.072**

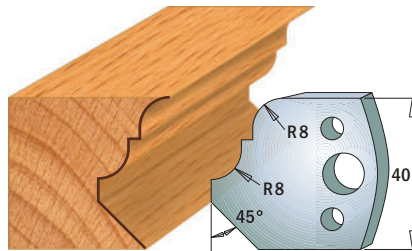

Pair of knives **690.073**
Pair of limiters **691.073**

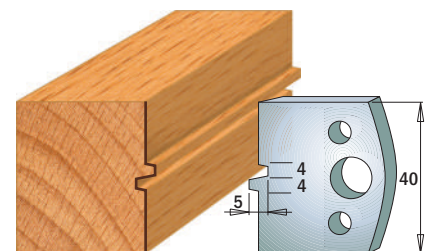

Pair of knives **690.074**
Pair of limiters **691.074**

NOTE: all knives & limiters available only in pairs.
Drawings are 1:2 scale. Dimensions in mm.

Profile Knives and Limiters

Cutting Length=40mm Thickness=4mm

Pack Qty. 10



SP

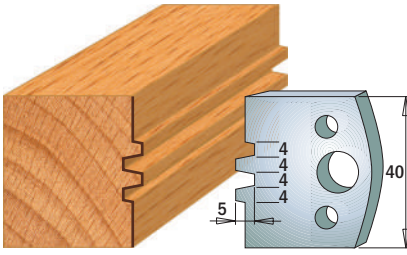

Pair of knives **690.075**
Pair of limiters **691.075**

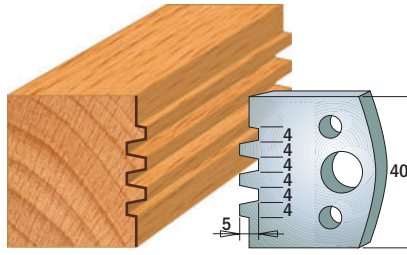

Pair of knives **690.076**
Pair of limiters **691.076**

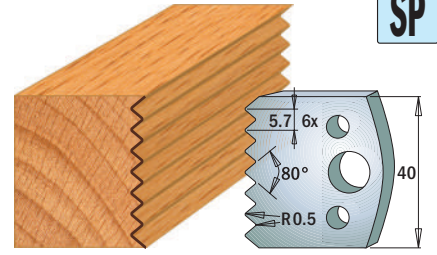

Pair of knives **690.077**
Pair of limiters **691.077**

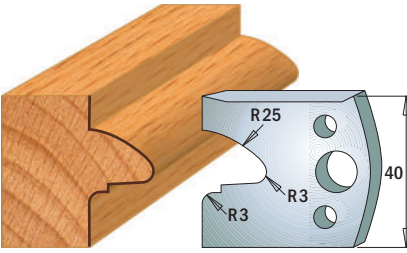

Pair of knives **690.078**
Pair of limiters **691.078**

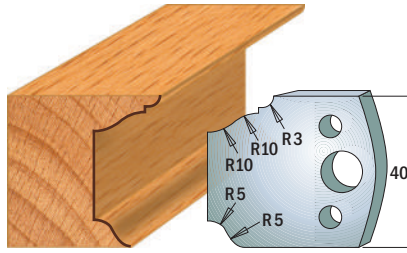

Pair of knives **690.079**
Pair of limiters **691.079**

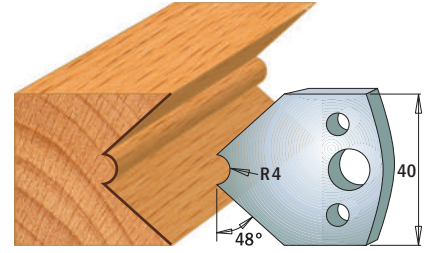

Pair of knives **690.080**
Pair of limiters **691.080**

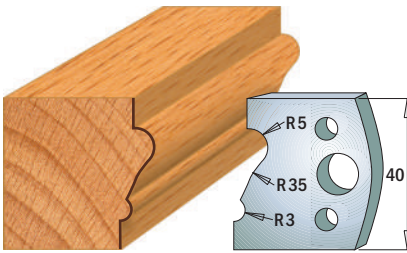

Pair of knives **690.081**
Pair of limiters **691.081**

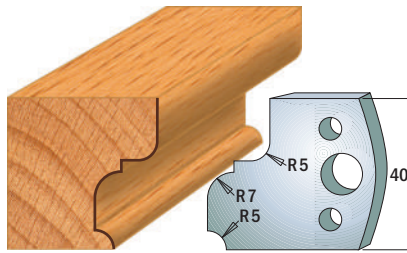

Pair of knives **690.082**
Pair of limiters **691.082**

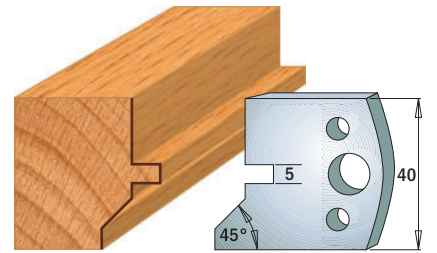

Pair of knives **690.083**
Pair of limiters **691.083**

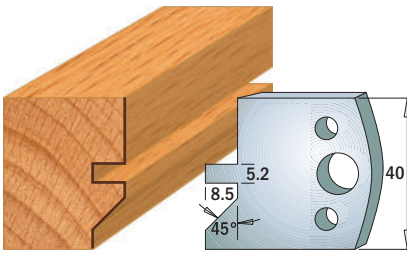

Pair of knives **690.084**
Pair of limiters **691.084**

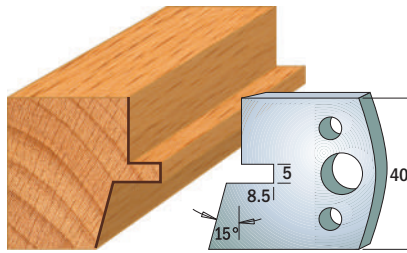

Pair of knives **690.085**
Pair of limiters **691.085**

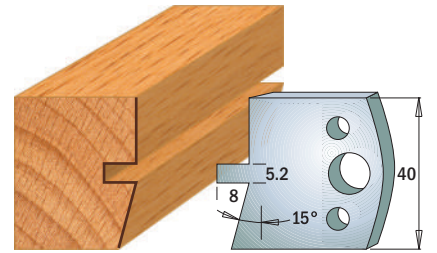

Pair of knives **690.086**
Pair of limiters **691.086**

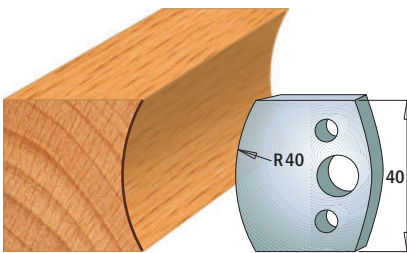

Pair of knives **690.087**
Pair of limiters **691.087**

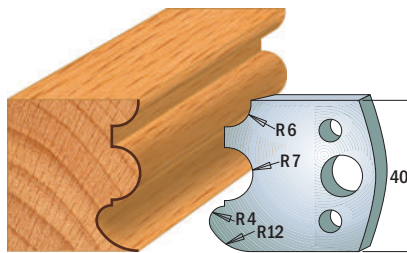

Pair of knives **690.088**
Pair of limiters **691.088**

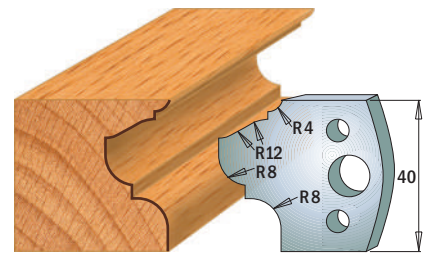

Pair of knives **690.089**
Pair of limiters **691.089**

NOTE: all knives & limiters available only in pairs.
Drawings are 1:2 scale. Dimensions in mm.

Profile Knives and Limiters

Cutting Length=40mm

Thickness=4mm

Pack Qty. 10



SP

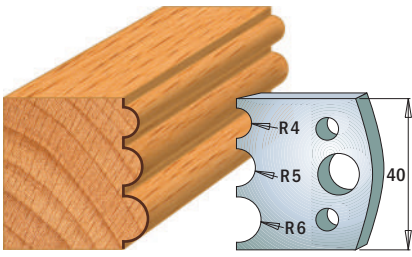

Pair of knives **690.090**
Pair of limiters **691.090**

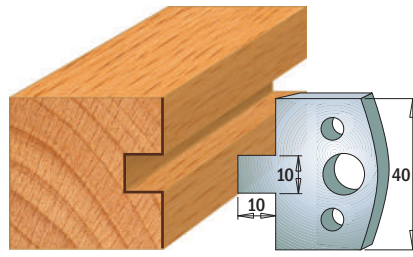

Pair of knives **690.091**
Pair of limiters **691.091**

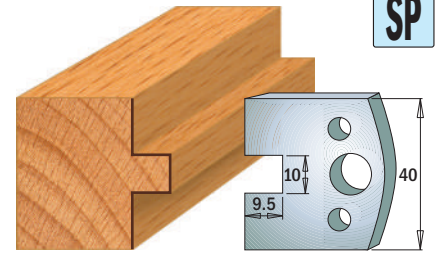

Pair of knives **690.092**
Pair of limiters **691.092**

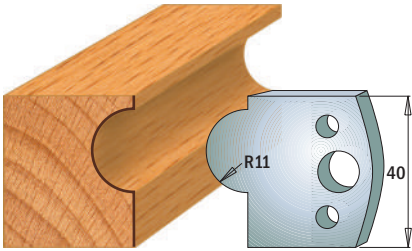

Pair of knives **690.093**
Pair of limiters **691.093**

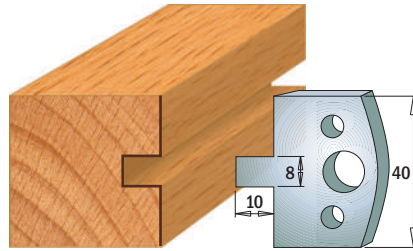

Pair of knives **690.094**
Pair of limiters **691.094**

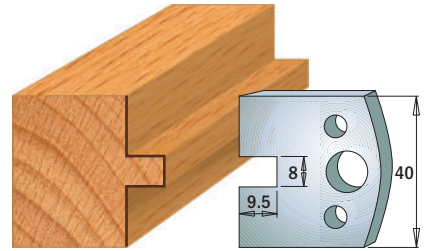

Pair of knives **690.095**
Pair of limiters **691.095**

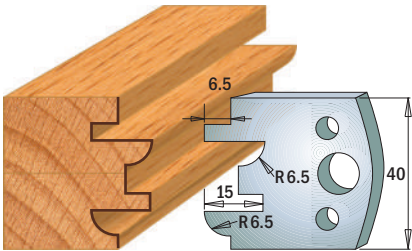

Pair of knives **690.096**
Pair of limiters **691.096**

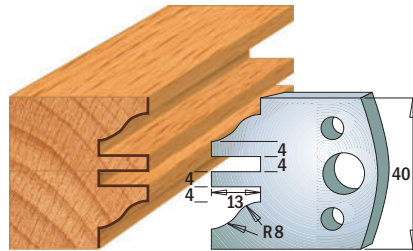

Pair of knives **690.097**
Pair of limiters **691.097**

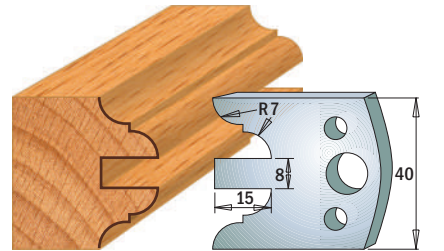

Pair of knives **690.098**
Pair of limiters **691.098**

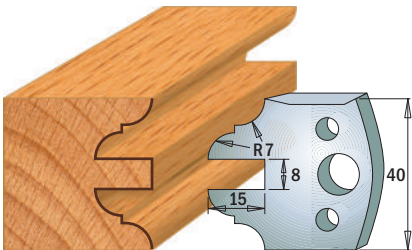

Pair of knives **690.099**
Pair of limiters **691.099**

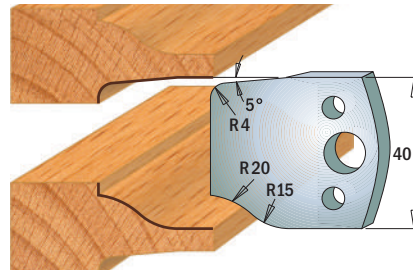

Pair of knives **690.100**
Pair of limiters **691.100**

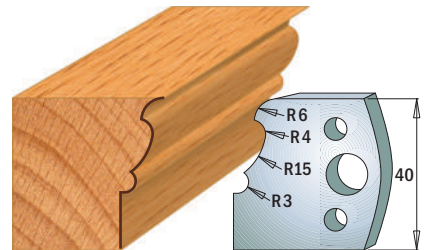

Pair of knives **690.101**
Pair of limiters **691.101**

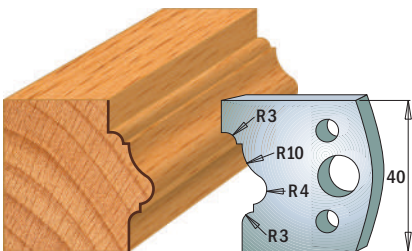

Pair of knives **690.102**
Pair of limiters **691.102**

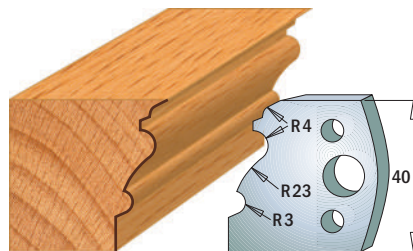

Pair of knives **690.103**
Pair of limiters **691.103**

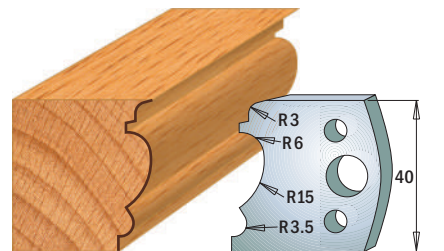

Pair of knives **690.104**
Pair of limiters **691.104**

NOTE: all knives & limiters available only in pairs.
Drawings are 1:2 scale. Dimensions in mm.

Profile Knives and Limiters

Cutting Length=40mm Thickness=4mm

Pack Qty. 10



SP

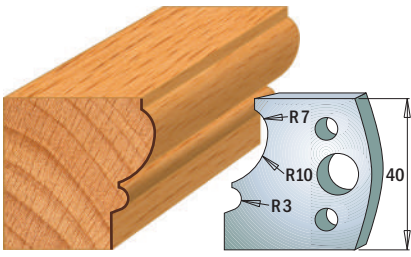

Pair of knives **690.105**
Pair of limiters **691.105**

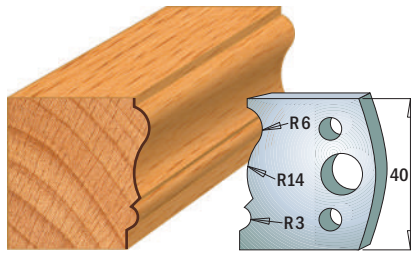

Pair of knives **690.106**
Pair of limiters **691.106**

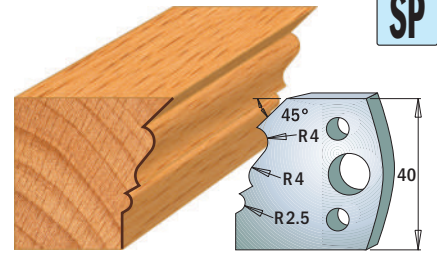

Pair of knives **690.107**
Pair of limiters **691.107**

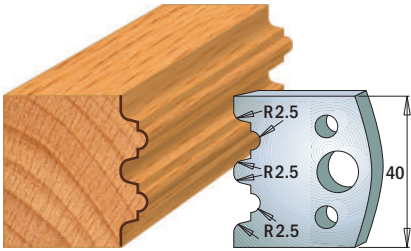

Pair of knives **690.108**
Pair of limiters **691.108**

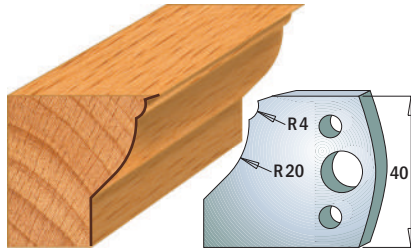

Pair of knives **690.109**
Pair of limiters **691.109**

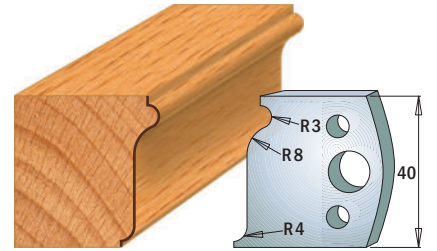

Pair of knives **690.110**
Pair of limiters **691.110**

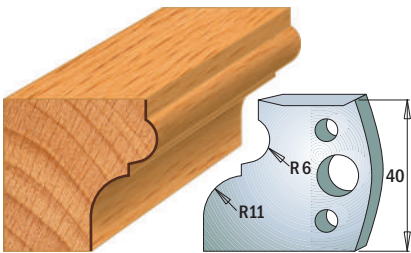

Pair of knives **690.111**
Pair of limiters **691.111**

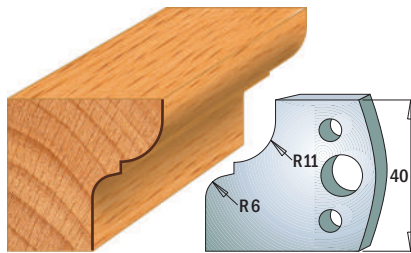

Pair of knives **690.112**
Pair of limiters **691.112**

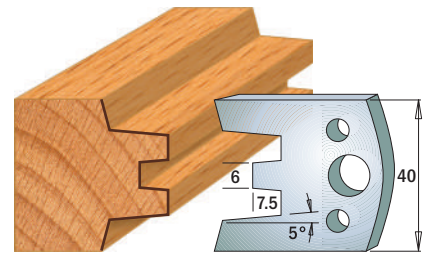

Pair of knives **690.113**
Pair of limiters **691.113**

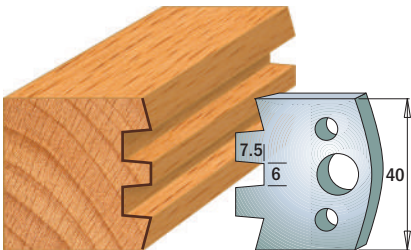

Pair of knives **690.114**
Pair of limiters **691.114**

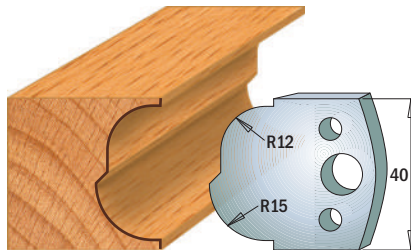

Pair of knives **690.115**
Pair of limiters **691.115**

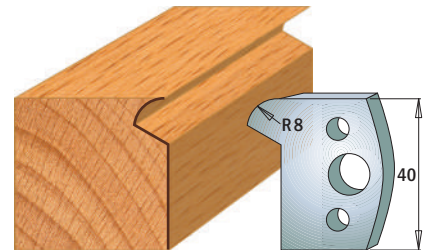

Pair of knives **690.116**
Pair of limiters **691.116**

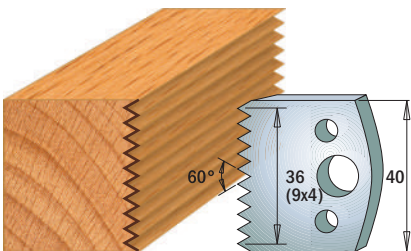

Pair of knives **690.117**
Pair of limiters **691.117**

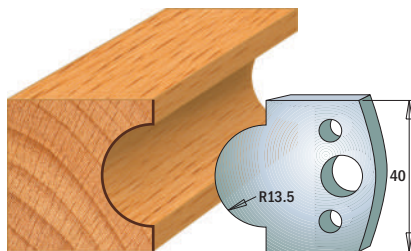

Pair of knives **690.118**
Pair of limiters **691.118**

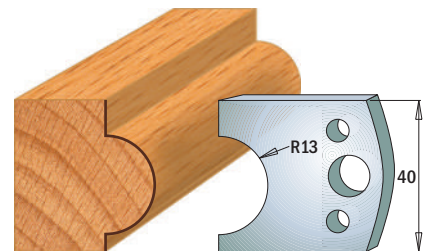

Pair of knives **690.119**
Pair of limiters **691.119**

NOTE: all knives & limiters available only in pairs.
Drawings are 1:2 scale. Dimensions in mm.

Profile Knives and Limiters

Cutting Length=40mm

Thickness=4mm

Pack Qty. 10

SP

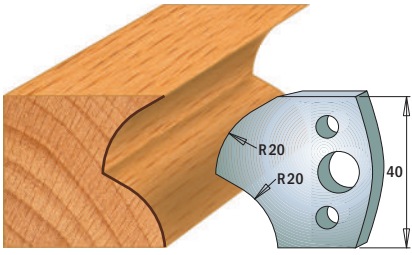

Pair of knives **690.120**
Pair of limiters **691.120**

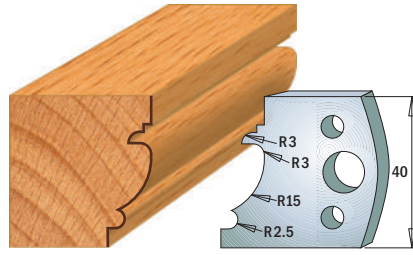

Pair of knives **690.121**
Pair of limiters **691.121**

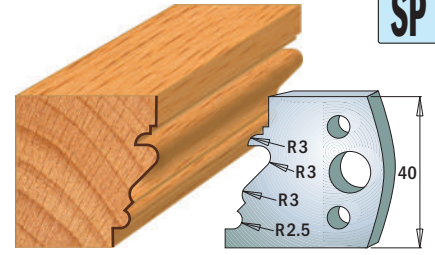

Pair of knives **690.122**
Pair of limiters **691.122**

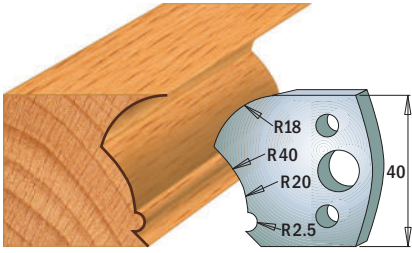

Pair of knives **690.123**
Pair of limiters **691.123**

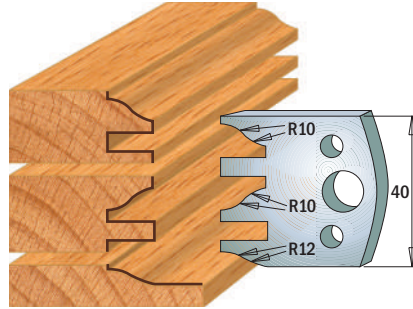

Pair of knives **690.124**
Pair of limiters **691.124**

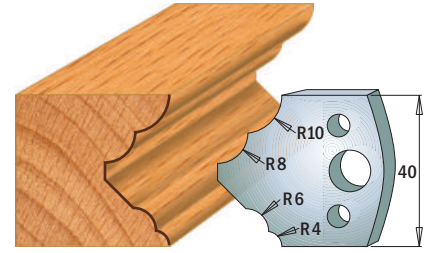

Pair of knives **690.125**
Pair of limiters **691.125**

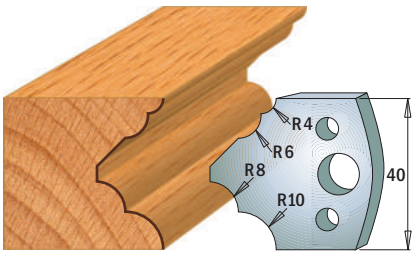

Pair of knives **690.126**
Pair of limiters **691.126**

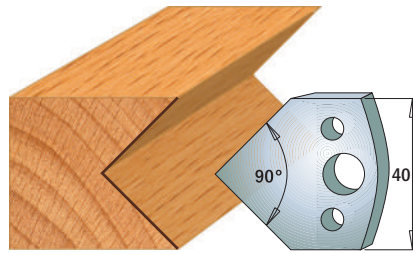

Pair of knives **690.127**
Pair of limiters **691.127**

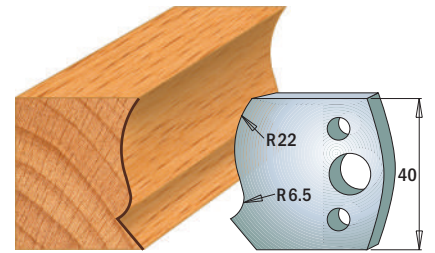

Pair of knives **690.128**
Pair of limiters **691.128**

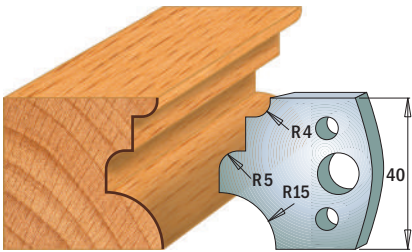

Pair of knives **690.129**
Pair of limiters **691.129**

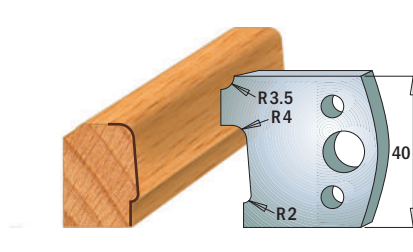

Pair of knives **690.130**
Pair of limiters **691.130**

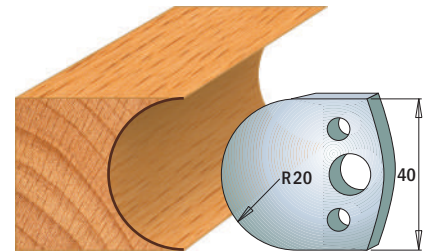

Pair of knives **690.131**
Pair of limiters **691.131**

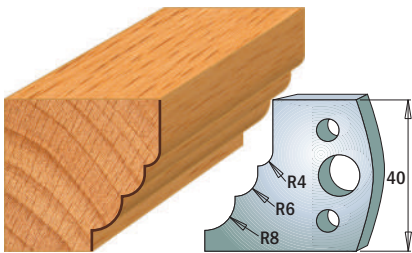

Pair of knives **690.132**
Pair of limiters **691.132**

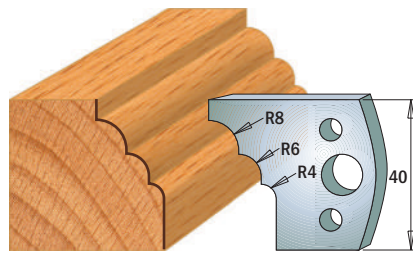

Pair of knives **690.133**
Pair of limiters **691.133**

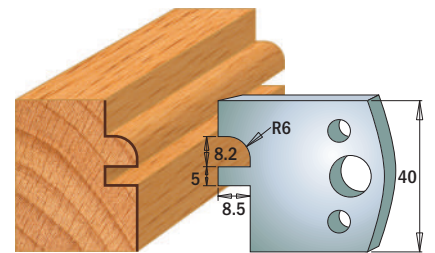

Pair of knives **690.134**
Pair of limiters **691.134**

NOTE: all knives & limiters available only in pairs.
Drawings are 1:2 scale. Dimensions in mm.

Profile Knives and Limiters

Cutting Length=40mm Thickness=4mm

Pack Qty. 10



SP

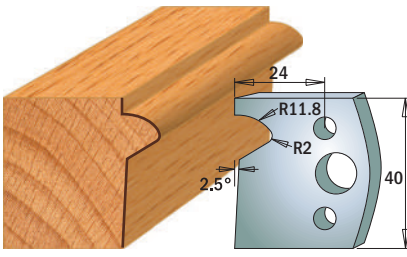

Pair of knives **690.135**
Pair of limiters **691.135**

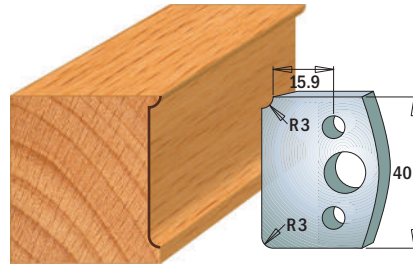

Pair of knives **690.170**
Pair of limiters **691.170**

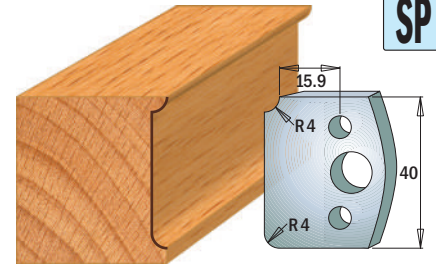

Pair of knives **690.171**
Pair of limiters **691.171**

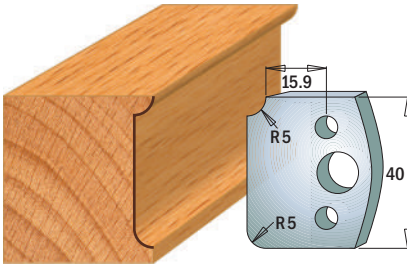

Pair of knives **690.172**
Pair of limiters **691.172**

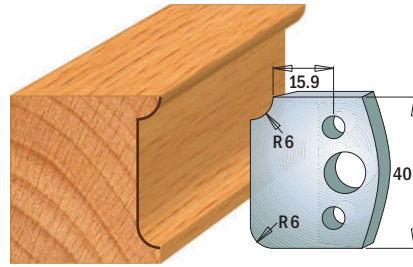

Pair of knives **690.173**
Pair of limiters **691.173**

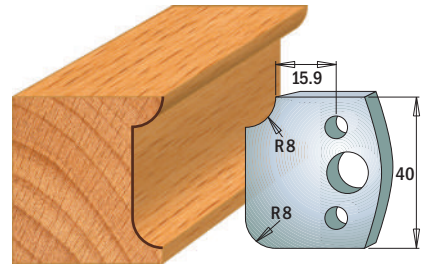

Pair of knives **690.174**
Pair of limiters **691.174**

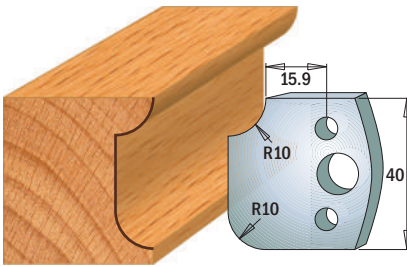

Pair of knives **690.175**
Pair of limiters **691.175**

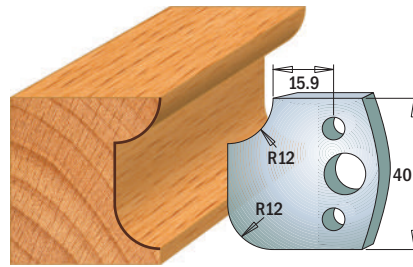

Pair of knives **690.176**
Pair of limiters **691.176**

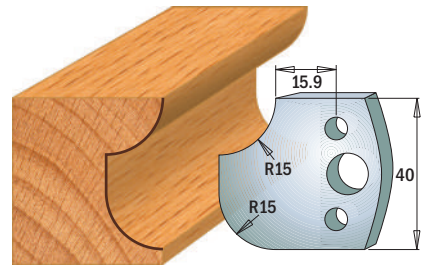

Pair of knives **690.177**
Pair of limiters **691.177**

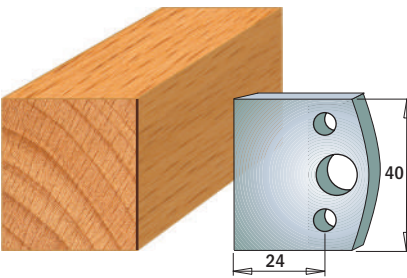

Pair of knives **690.192**
Pair of limiters **691.192**

Profile Knives and Limiters
Cutting Length=50mm
Thickness=4mm
Pack Qty. 10

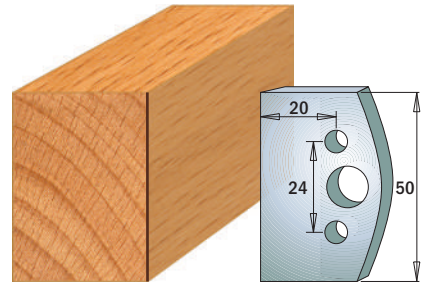

Pair of knives **690.500**
Pair of limiters **691.500**

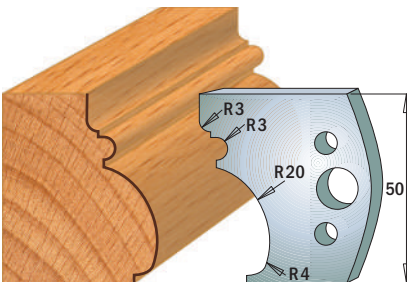

Pair of knives **690.501**
Pair of limiters **691.501**

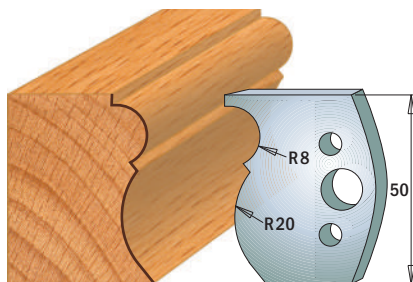

Pair of knives **690.502**
Pair of limiters **691.502**

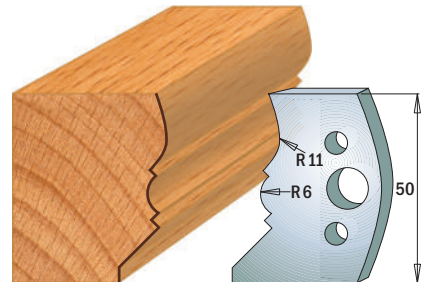

Pair of knives **690.503**
Pair of limiters **691.503**

NOTE: all knives & limiters available only in pairs.
Drawings are 1:2 scale. Dimensions in mm.

Profile Knives and Limiters

Cutting Length=50mm

Thickness=4mm

Pack Qty. 10



SP

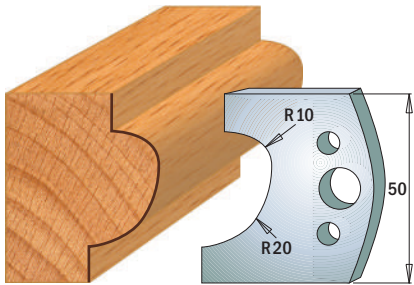

Pair of knives **690.504**
Pair of limiters **691.504**

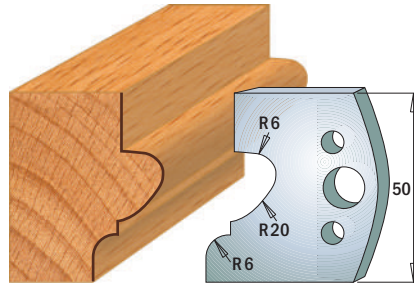

Pair of knives **690.505**
Pair of limiters **691.505**

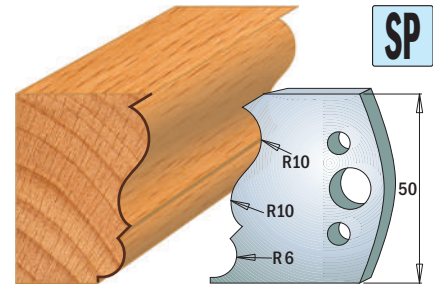

Pair of knives **690.506**
Pair of limiters **691.506**

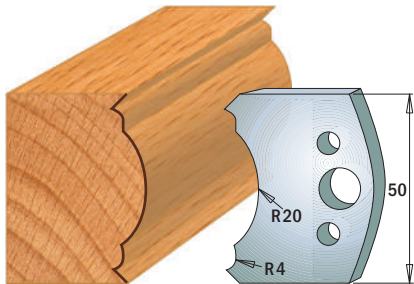

Pair of knives **690.507**
Pair of limiters **691.507**

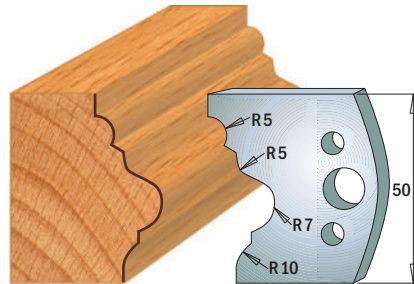

Pair of knives **690.508**
Pair of limiters **691.508**

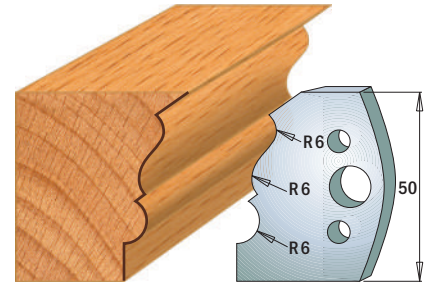

Pair of knives **690.509**
Pair of limiters **691.509**

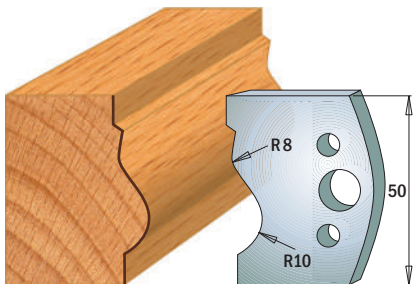

Pair of knives **690.510**
Pair of limiters **691.510**

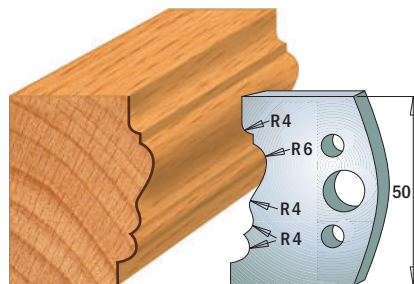

Pair of knives **690.511**
Pair of limiters **691.511**

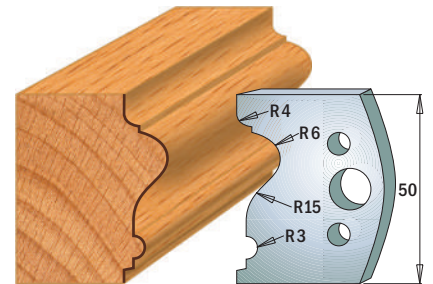

Pair of knives **690.512**
Pair of limiters **691.512**

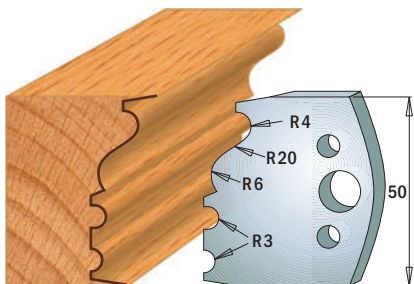

Pair of knives **690.513**
Pair of limiters **691.513**

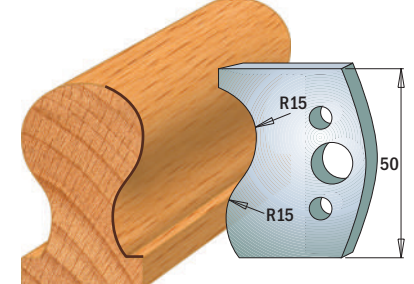

Pair of knives **690.514**
Pair of limiters **691.514**

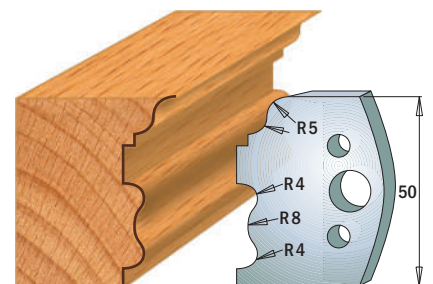

Pair of knives **690.515**
Pair of limiters **691.515**

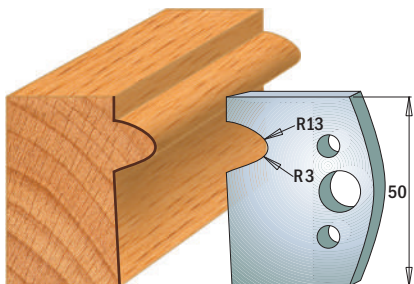

Pair of knives **690.516**
Pair of limiters **691.516**

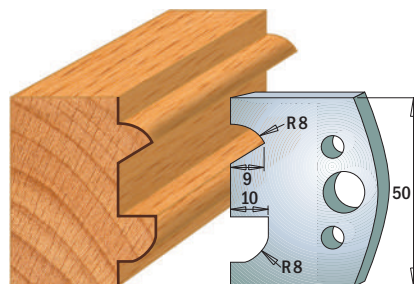

Pair of knives **690.517**
Pair of limiters **691.517**

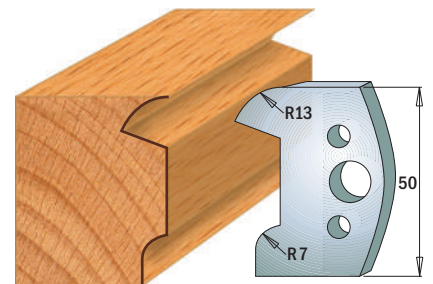

Pair of knives **690.518**
Pair of limiters **691.518**

NOTE: all knives & limiters available only in pairs.
Drawings are 1:2 scale. Dimensions in mm.

Profile Knives and Limiters

Cutting Length=50mm Thickness=4mm

Pack Qty. 10



SP

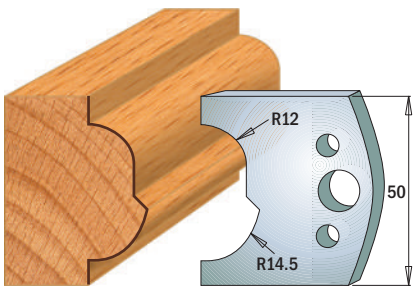

Pair of knives **690.519**
Pair of limiters **691.519**

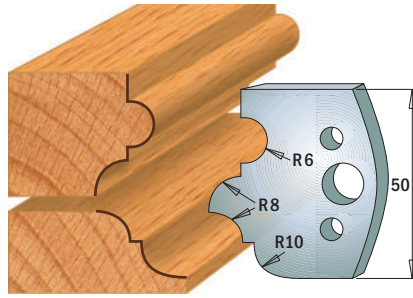

Pair of knives **690.520**
Pair of limiters **691.520**

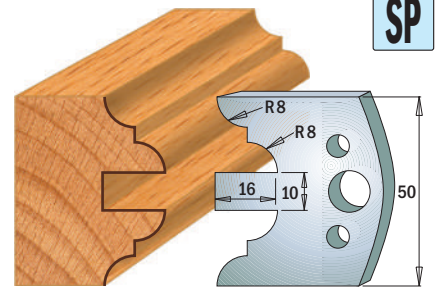

Pair of knives **690.522**
Pair of limiters **691.522**

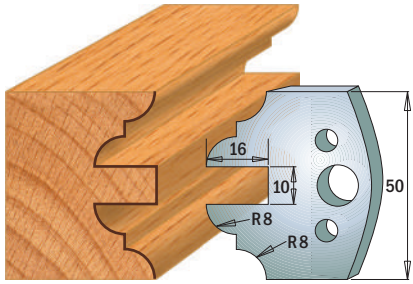

Pair of knives **690.523**
Pair of limiters **691.523**

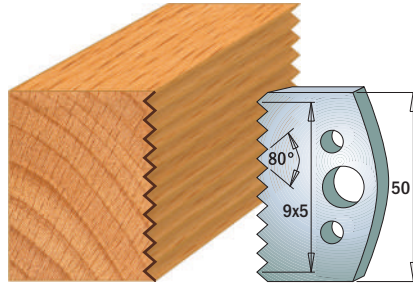

Pair of knives **690.524**
Pair of limiters **691.524**

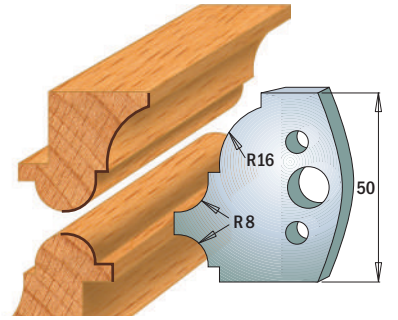

Pair of knives **690.541**
Pair of limiters **691.541**

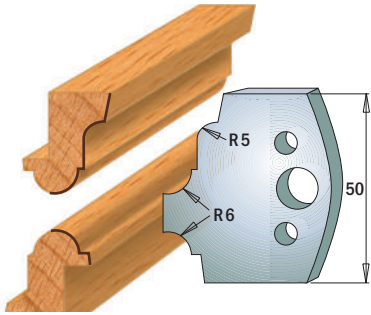

Pair of knives **690.542**
Pair of limiters **691.542**

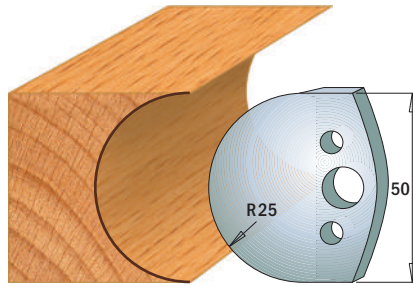

Pair of knives **690.543**
Pair of limiters **691.543**

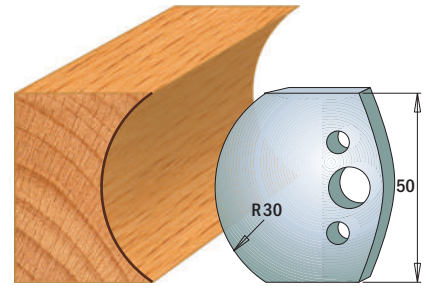

Pair of knives **690.544**
Pair of limiters **691.544**

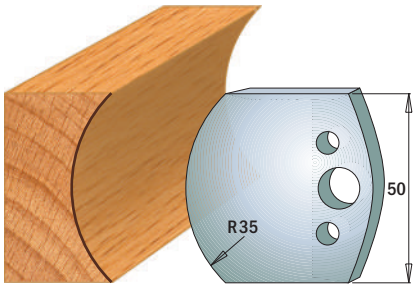

Pair of knives **690.545**
Pair of limiters **691.545**

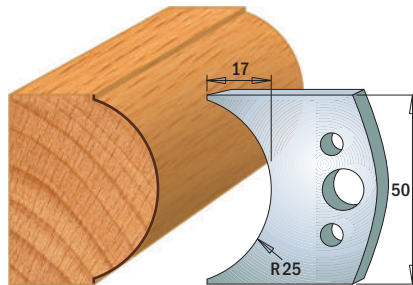

Pair of knives **690.546**
Pair of limiters **691.546**

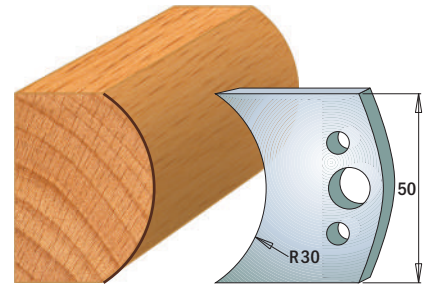

Pair of knives **690.547**
Pair of limiters **691.547**

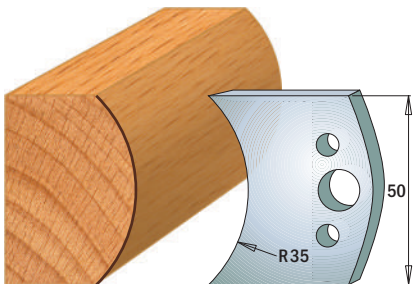

Pair of knives **690.548**
Pair of limiters **691.548**

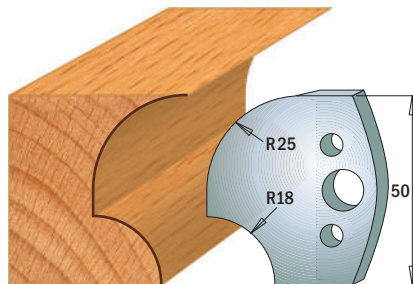

Pair of knives **690.549**
Pair of limiters **691.549**

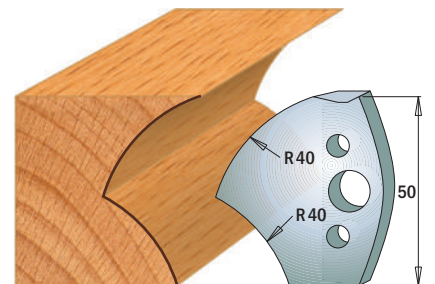

Pair of knives **690.550**
Pair of limiters **691.550**

NOTE: all knives & limiters available only in pairs.
Drawings are 1:2 scale. Dimensions in mm.

Profile Knives and Limiters

Cutting Length=50mm Thickness=4mm

Pack Qty. 10

SP

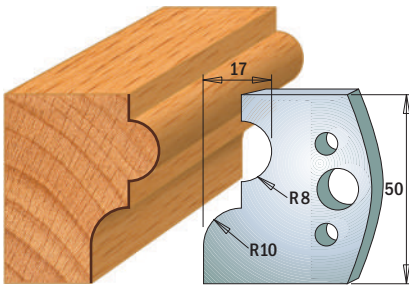

Pair of knives **690.551**
Pair of limiters **691.551**

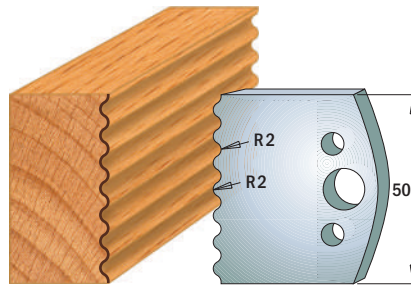

Pair of knives **690.552**
Pair of limiters **691.552**

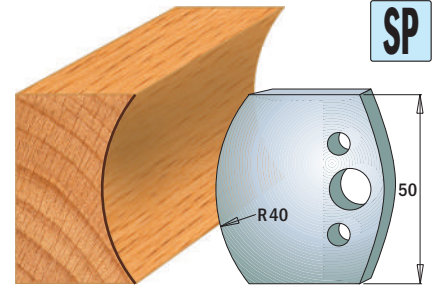

Pair of knives **690.553**
Pair of limiters **691.553**

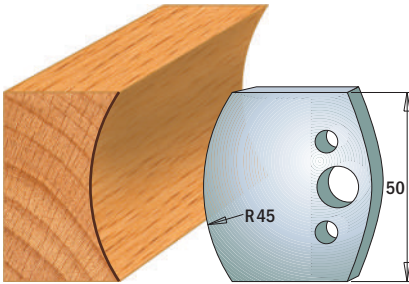

Pair of knives **690.554**
Pair of limiters **691.554**

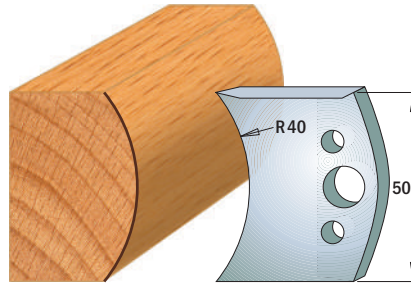

Pair of knives **690.555**
Pair of limiters **691.555**

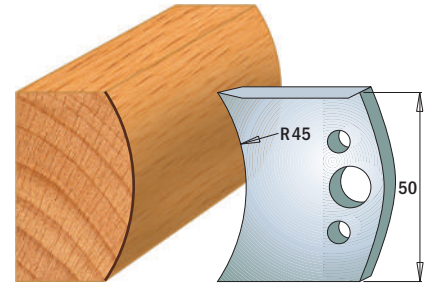

Pair of knives **690.556**
Pair of limiters **691.556**

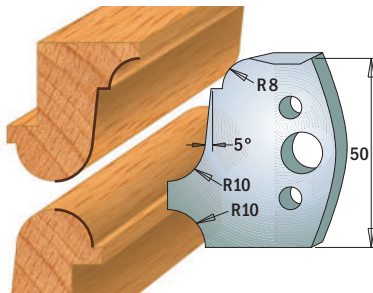

Pair of knives **690.557**
Pair of limiters **691.557**

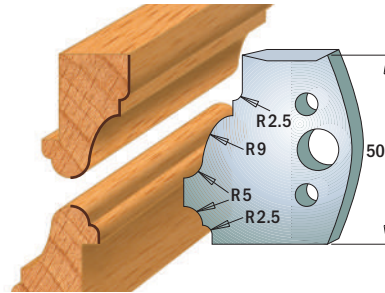

Pair of knives **690.558**
Pair of limiters **691.558**

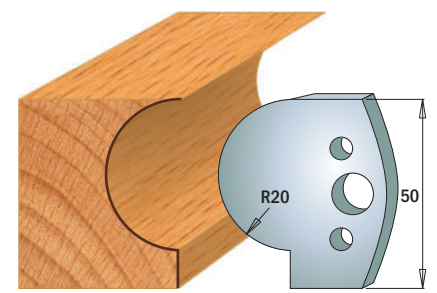

Pair of knives **690.562**
Pair of limiters **691.562**

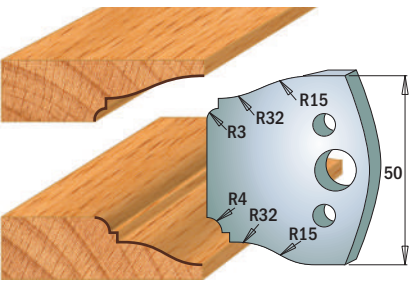

Pair of knives **690.568**
Pair of limiters **691.568**

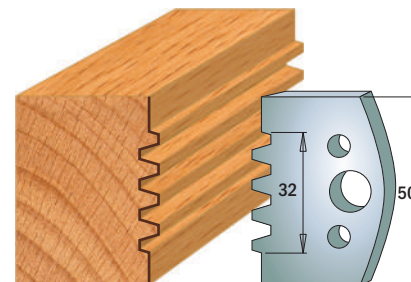

Pair of knives **690.576**
Pair of limiters **691.576**

NOTE: all knives & limiters available only in pairs.
Drawings are 1:2 scale. Dimensions in mm.

690-691

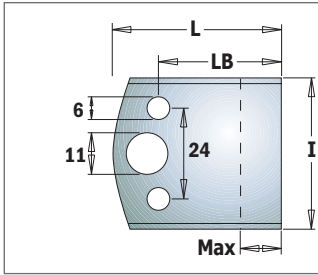

DESCRIPTION	I mm	LB mm	L mm	Max mm		ORDER NO. SP	ORDER NO. HSS
Pair of knives	40	32,5	44,5	18	10	690.193	690.193H
Pair of knives	50	34	46	20	10	690.599	690.599H
Pair of limiters	38	16	28	2	10	691.190	
Pair of limiters	38	24	36	10	10	691.192	
Pair of limiters	38	32,5	44,5	18	10	691.193	
Pair of limiters	48	34	46	20	10	691.599	

Pair of Bore Reducers

699

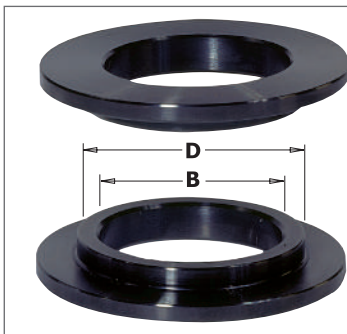

D mm	B mm		ORDER NO.	D mm	B mm		ORDER NO.
19,05	12,7	10	699.019.13	35	32	10	699.035.32
25,4	19,05	10	699.026.19	40	30	10	699.040.30
30	19,05	10	699.030.19	40	32	10	699.040.32
30	25,4	10	699.030.26	40	35	10	699.040.35
31,75	19,05	10	699.031.19	50	30	1	699.050.30
31,75	25,4	10	699.031.26	50	32	1	699.050.32
31,75	30	10	699.031.30	50	35	1	699.050.35
35	30	10	699.035.30	50	40	1	699.050.40
35	31,75	10	699.035.31				

To be used only in pairs

Chucks & "ER20" Collets for Spindle Moulder Machine

796

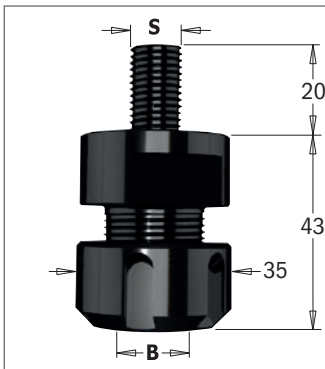

S mm	B mm	L mm		ORDER NO.
M12x1,75	3 ~ 12,7	43	10	796.122.00
M14x2	3 ~ 12,7	43	10	796.142.00
M16x2	3 ~ 12,7	43	10	796.162.00

Spare parts: **992.483.03** M25x1,5mm clamping nut
991.483.00 "ER20" key

TECHNICAL DETAILS:

Super strength steel.
Precisely machined for accuracy.

Collet not included



SAFETY TIPS: The **TW-200** Torque Wrench is recommended for the proper fastening of clamping nuts. (see page 406)

"ER20" Precision Collets for Chucks 796.122/142/162





184



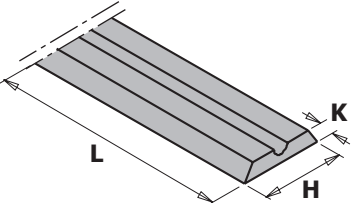

B mm		ORDER NO.	B mm		ORDER NO.
2	10	184.020.20	10	10	184.100.20
3	10	184.030.20	11	10	184.110.20
4	10	184.040.20	12	10	184.120.20
5	10	184.050.20	12,7	10	184.127.20
6	10	184.060.20			
6,35	10	184.064.20			
7	10	184.070.20			
8	10	184.080.20			
9	10	184.090.20			



790

	L mm	H mm	K mm	MACHINE	MODEL MACHINE	ORDER NO.	ORDER NO.
						2-pcs. blister case	10-pcs. blister case
    10-PCS. CASE (MINIMUM ORDER)  2-PCS. BLISTER CASE (790.755/790.780/790.806/790.805/790.820)	56 x 5,5 x 1,1	ADLER®					790.560.00
	60 x 5,5 x 1,1	WEGOMA®					790.600.01
	75,5 x 5,5 x 1,1	AEG®	HTH75				790.755.00
		BLACK & DECKER®	DN75, 750SR, 600K				
		BOSCH®	0590, P400, 1590,1591				
		FESTOOL®	REP75				
		HAFFNER®	FH222				
		HOLZ-HER®	2223, 2286, 2320				
		KRESS®	JET-STAR 6701, 6702				
		MAFELL®	HU75				
		METABO®	6375				
		SCHEER®	MH75/3, MH80				
	SKIL®	98H					
	78 x 5,5 x 1,1	VIRUTEX®				790.780	790.780.00
	80,5 x 5,5 x 1,1	AEG®, BOSCH®				790.805	790.805.01
HAFFNER®							
ELU®		MFF40, MFF80, MFF81, MFF81EK, PF161					
82 x 5,5 x 1,1	AEG®	EH82, EH825, EH822, EH450, EH700, EH82-1, H500, H750, EH700R			790.820	790.820.00	
	BLACK & DECKER®	DN76					
	BOSCH®	PHO 100/150, PHO 200/300 4387, PHO 2-82/3-82, GUSTAV, H00882					
	CASALS®	CE82					
	DEWALT®	DW678, DW678EK, DW680					
	ELU®	HH15, HH40, HH40K, HH40EK					
	FEIN®	HS2151					
	FELISATTI®	TP282					
	HAFFNER®	FH224					
	HITACHI®	F20, F20A, FP20A, P20V, P20SA					
	HOLZ-HER®	2321, 2322					
	LEGNA®	R82, G82					
	MAFELL®	EHU82, MHU82					
	MAKITA®	1001, 1100, 1125B, 1900B, 1901, 1923B, 1923H, 1923HO					
	METABO®	4382, 8382, 0882, 0883, E0983					
	PERLES®	HHB82B					
	PEUGEOT®	RA400, 82RAC, RA82CS, BR82 BRA1-82, BRA3-82, RA1082CA					
	RYOBI®	L1323-A					
	SKIL®	H92, H94, H95, H96, H97 1506, 1510					
	STAYER®	980B					
	92 x 5,5 x 1,2	AEG®	450				790.920.00
		HITACHI®	F30A, FU30				
	RYOBI®	L120N, L150N, L1205N, L1323					
102 x 5,5 x 1,1	AEG®	HB750, EH102, HBE800				790.992.00	

	L mm	H mm	K mm	MACHINE	MODEL MACHINE	ORDER NO.	ORDER NO.
						2-pcs. HSS	2-pcs. HW
  2-PCS. BLISTER CASE	82	x 29	x 3	BOSCH®	GH020-82	790.821.50	790.821.10
				BLACK & DECKER®	DN710, DB711		
				MAKITA®	1900B, 1923B, 1100, 1901 1125		
				RYOBI®	L-1323A, L-282		
	110	x 29	x 3	MAKITA®	1002BA, 1911B	790.110.50	
				TECHNICAL DETAILS:		APPLICATION:	
				- Order no. ISO: K40		Softwood Good	
				- Hardness (HV10): 1.400		Hardwood Suitable	
				- Transverse rupture strength (N/mm ²): 2.600		Plywood Suitable	

793

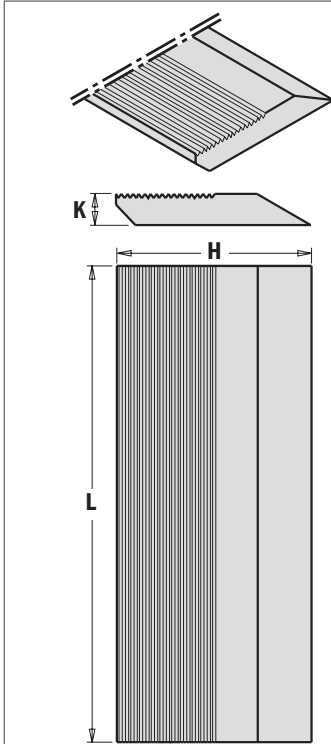

IN QUADROPACK PACKAGING
4 KNIVES FOR EACH SET

L mm	H mm	K mm	ORDER NO. pieces for each set		ORDER NO. HSS
40 x	50 x	8	4	1	793.040.50 ■
40 x	60 x	8	4	1	793.040.60 ■
40 x	70 x	8	4	1	793.040.70 ■
60 x	50 x	8	4	1	793.060.50 ■
60 x	60 x	8	4	1	793.060.60 ■
60 x	70 x	8	4	1	793.060.70 ■
80 x	50 x	8	4	1	793.080.50 ■
80 x	60 x	8	4	1	793.080.60 ■
80 x	70 x	8	4	1	793.080.70 ■
100 x	50 x	8	4	1	793.100.50 ■
100 x	60 x	8	4	1	793.100.60 ■
100 x	70 x	8	4	1	793.100.70 ■
120 x	50 x	8	4	1	793.120.50 ■
120 x	60 x	8	4	1	793.120.60 ■
120 x	70 x	8	4	1	793.120.70 ■
130 x	60 x	8	4	1	793.130.60 ■
130 x	70 x	8	4	1	793.130.70 ■
650 x	40 x	8	4	1	793.650.40 ■
650 x	50 x	8	4	1	793.650.50 ■
650 x	60 x	8	4	1	793.650.60 ■
650 x	70 x	8	4	1	793.650.70 ■

■ Until stock last

REMARK: special dimensions available on request.

TECHNICAL DETAILS:

Corrugated back moulder knives for profile cutter heads with precise positioning, angle 60°, pitch 1,6mm.

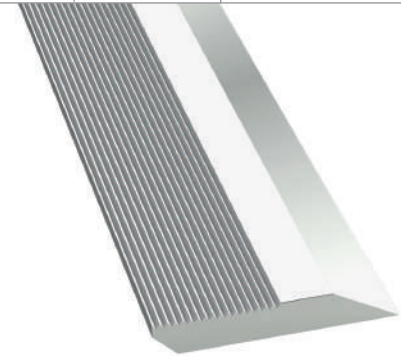

MATERIAL	HSS
Dry softwood	●
Wet softwood	●
Dry hardwood	●
Wet hardwood	○

- Suitable
- Party suitable

Set of 2 Magnetic Knife Setting Jigs



Insert your knives into the tool holders and align them perfectly with this set! Perfect micro adjustments on will guarantee excellent cutting performance!

1. MAGNETIC STOP
2. JOINTS WITH MAGNETIC CONNECTORS
3. LOCK SCREW

CMT792

2 setup possibilities

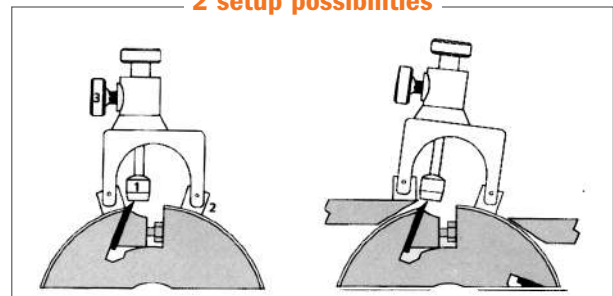

Positioning on the tool holder body with detection of the knife position.

Direct positioning on both the planer table and the tool holder body with detection of the knife position.

DESCRIPTION		ORDER NO.
Set of 2 magnetic knife setting jigs	25	CMT792

792

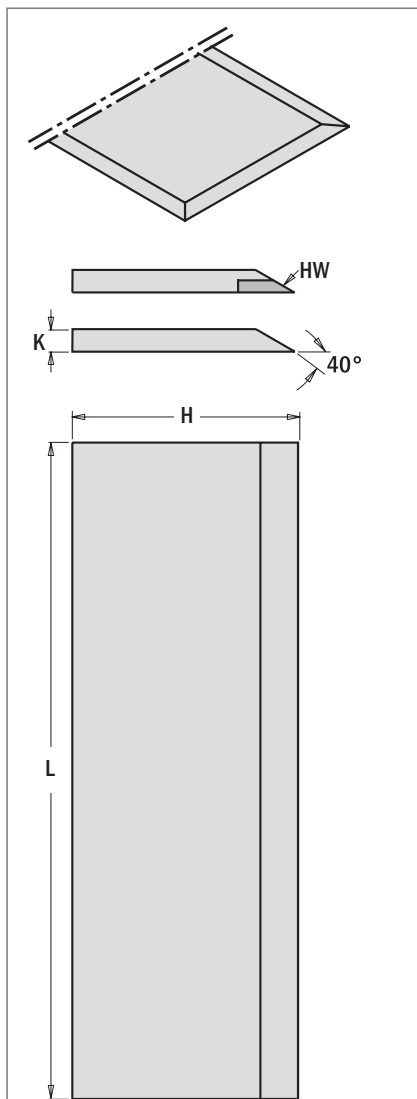

IN QUADROPACK PACKAGING
2 KNIVES FOR EACH SET

* The HSS knives are balanced and milled.

L mm	H mm	K mm	KNIVES pieces for each set		ORDER NO. SP	ORDER NO. HSS*	ORDER NO. HW
130 x	30 x	3	2	1		792.130.30	792.132.30
150 x	30 x	3	2	1		792.150.30	
180 x	30 x	3	2	1		792.180.30	792.182.30
200 x	30 x	3	2	1		792.200.30	
210 x	30 x	3	2	1		792.210.30	
230 x	30 x	3	2	1		792.230.30	792.232.30
250 x	30 x	3	2	1	792.251.30	792.250.30	792.252.30
260 x	30 x	3	2	1	792.261.30	792.260.30	792.262.30
300 x	30 x	3	2	1	792.301.30	792.300.30	792.302.30
310 x	30 x	3	2	1		792.310.30	792.312.30
350 x	30 x	3	2	1		792.350.30	792.352.30
400 x	30 x	3	2	1	792.401.30	792.400.30	792.402.30
410 x	30 x	3	2	1		792.410.30	792.412.30
430 x	30 x	3	2	1		792.430.30	
450 x	30 x	3	2	1	792.451.30	792.450.30	
500 x	30 x	3	2	1	792.501.30	792.500.30	792.502.30
510 x	30 x	3	2	1		792.510.30	792.512.30
520 x	30 x	3	2	1		792.520.30	792.522.30
530 x	30 x	3	2	1		792.530.30	792.532.30
600 x	30 x	3	2	1		792.600.30	
610 x	30 x	3	2	1		792.610.30	
630 x	30 x	3	2	1		792.630.30	792.632.30
640 x	30 x	3	2	1		792.640.30	
810 x	30 x	3	2	1		792.810.30	
1050 x	30 x	3	2	1	792.998.30	792.997.30	792.999.30
300 x	35 x	3	2	1		792.300.35	
350 x	35 x	3	2	1		792.350.35	
400 x	35 x	3	2	1	792.401.35	792.400.35	
410 x	35 x	3	2	1		792.410.35	
430 x	35 x	3	2	1		792.430.35	
450 x	35 x	3	2	1	792.451.35	792.450.35	
500 x	35 x	3	2	1	792.501.35	792.500.35	
510 x	35 x	3	2	1	792.511.35	792.510.35	
520 x	35 x	3	2	1	792.521.35	792.520.35	
530 x	35 x	3	2	1		792.530.35	
550 x	35 x	3	2	1	792.551.35	792.550.35	
600 x	35 x	3	2	1	792.601.35	792.600.35	
610 x	35 x	3	2	1	792.611.35	792.610.35	
630 x	35 x	3	2	1	792.631.35	792.630.35	
650 x	35 x	3	2	1		792.650.35	
710 x	35 x	3	2	1		792.710.35	
810 x	35 x	3	2	1		792.810.35	
820 x	35 x	3	2	1			
1050 x	35 x	3	2	1	792.998.35	792.997.35	

MATERIAL	SP	HSS	HW
Dry softwood	○	●	
Wet softwood	○	○	
Dry hardwood	○	●	●
Wet hardwood	○	●	○
Chipboard			○
MDF			○
Glulam		○	●
Solid surface			○

- Suitable
- Partly suitable

REMARK: special dimensions available on request.
The mirror finish on HW knives produces both razor sharp and extremely durable cutting edges.



795

TERSA®

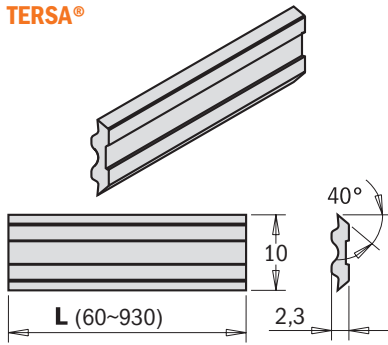

**CENTROSTAR
CENTROFIX
QUICKFIX**

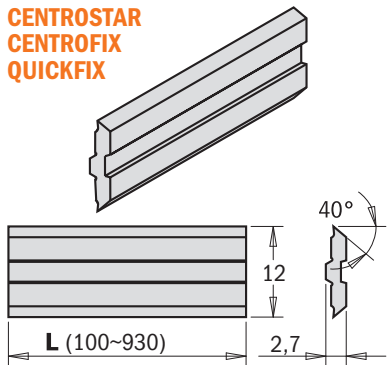

CENTROLOCK

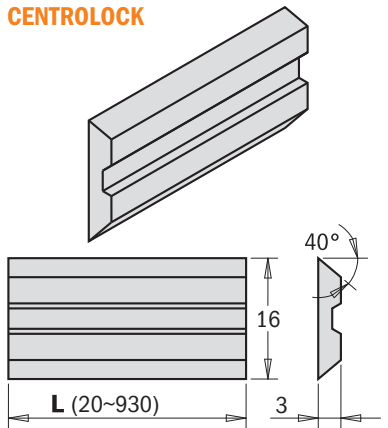

2 KNIVES FOR EACH SET

TERSA®

CENTROSTAR, CENTROFIX, QUICKFIX

CENTROLOCK

L mm	H mm	K mm	ORDER NO.	L mm	H mm	K mm	ORDER NO.	L mm	H mm	K mm	ORDER NO.
100	10	2,3	795.100.10								
110	10	2,3	795.110.10								
120	10	2,3	795.120.10								
130	10	2,3	795.130.10	130	12	2,7	795.130.12	130	16	3	795.130.16
180	10	2,3	795.180.10	180	12	2,7	795.180.12	170	16	3	795.170.16
210	10	2,3	795.210.10					180	16	3	795.180.16
230	10	2,3	795.230.10					190	16	3	795.190.16
260	10	2,3	795.260.10					230	16	3	795.230.16
300	10	2,3	795.300.10					240	16	3	795.240.16
310	10	2,3	795.310.10	310	12	2,7	795.310.12	240	16	3	795.240.16
350	10	2,3	795.350.10					260	16	3	795.260.16
400	10	2,3	795.400.10					270	16	3	795.270.16
410	10	2,3	795.410.10	410	12	2,7	795.410.12				
420	10	2,3	795.420.10								
430	10	2,3	795.430.10								
450	10	2,3	795.450.10								
500	10	2,3	795.500.10								
510	10	2,3	795.510.10	510	12	2,7	795.510.12				
520	10	2,3	795.520.10	520	12	2,7	795.520.12				
530	10	2,3	795.530.10								
540	10	2,3	795.540.10								
630	10	2,3	795.630.10	630	12	2,7	795.630.12				
640	10	2,3	795.640.10	640	12	2,7	795.640.12				
930	10	2,3	795.930.10					930	16	3	795.930.16 ■

■ *Until stock last*

TECHNICAL DETAILS:

HPS® is a material specially formulated using special heat treatments developed for the woodworking industry by Thyssen-Krupp. This steel is enhanced with the following special attributes:

- superb wear resistance
- maximum level of toughness
- resistance to softening
- easy to profile - tested for long life

Test results on Oak: - Spindle speed=6000 rpm,
- Feed speed=24 meter/min
= Result HPS® 17500 meters.
= Result HSS 10000 meters.

MATERIAL	GOOD	EXCELLENT
Dry Softwood		●
Wet Softwood		●
Dry Hardwood		●
Wet Hardwood		●
Exotic Hardwood	●	

790



	L mm	H mm	K mm	TYPE	A	Z	ORDER NO. K1920	ORDER NO. K2250
	7,5	12	1,5			35°	2	790.075.00
7,65	12	1,5			35°	2	790.076.00	
9,6	12	1,5			35°	2	790.096.00	
15	12	1,5			35°	2	790.150.00	
19,5	12	1,5			35°	4	790.195.12	
20	12	1,5			35°	2	790.200.00	790.200.03

	L mm	H mm	K mm	A	Z	ORDER NO. K1920	ORDER NO. K2250
	24,7	12	1,5		35°	2	790.250.00
30	12	1,5		35°	2	790.300.00	790.300.03
30	12	1,5		45°	2	790.300.20	
40	12	1,5		35°	2	790.400.00	790.400.03
50	12	1,5		35°	2	790.500.00	790.500.03
60	12	1,5		35°	2	790.600.00	790.600.03

	L mm	H mm	K mm	TYPE	A	Z	ORDER NO. K1920	ORDER NO. K2250
	29,5	9	1,5			35°	4	790.295.09
29,5	12	1,5			35°	4	790.295.12	
39,5	9	1,5			35°	4	790.395.09	
39,5	12	1,5			35°	4	790.395.12	
49,2	9	1,5			35°	4	790.495.09	
49,2	12	1,5			35°	4	790.495.12	
58	12	1,5			35°	2	790.580.01	

	L mm	H mm	K mm	A	Z	ORDER NO. K1920	ORDER NO. K2250
	28,3	12	1,5		35°	4	790.283.12
48,3	12	1,5		35°	4	790.483.12	

	L mm	H mm	K mm	A	Z	ORDER NO. K1920	ORDER NO. K2250
	10,5	10,5	1,5		35°	4	
12	12	1,5		35°	4	790.120.00	790.120.03

	L mm	H mm	K mm	A	Z	ORDER NO. K1920	ORDER NO. K2250	
	13,6	13,6	2		30°	4	790.136.00	
	14	14	1,2		30°	4	790.140.10	
	14	14	2		30°	4	790.140.00	790.140.03
14	14	2		45°	4	790.140.02		

	L mm	H mm	K mm	A	Z	ORDER NO. K1920	ORDER NO. K2250	
	12	12	1,5		30°	4	790.120.20	
	14	14	2		30°	4	790.140.20	

	L mm	H mm	K mm	R mm	A	Z	ORDER NO. K1920	ORDER NO. K2250
	15	15	2,5	115	30°	4	790.152.12	
	15	15	2,5	150	30°	4	790.152.22	

	L mm	H mm	K mm	A	Z	ORDER NO. K1920	ORDER NO. K2250	
	20	4,1	1,1		35°	4	790.200.01	
	30	5,5	1,1		35°	4	790.300.01	
50	5,5	1,1		35°	4	790.500.01		

790



	L mm	H mm	K mm		A	Z	ORDER NO. K1920
	50	9	1,5		35°	4	790.500.09
	50	12	1,7		35°	4	790.503.00

	L mm	H mm	K mm	B	A	Z	ORDER NO. K1920
	20	12	1,5	1	35°	2	790.201.00
	24	12	1,5	1	35°	2	S790.242.00
	30	12	1,5	2	35°	2	790.301.00
	50	12	1,5	2	35°	2	790.501.00

	L mm	H mm	K mm		Z	ORDER NO. K1920
	18	18	1,95		4	790.181.00
	18	18	2,45		4	790.182.00

	L mm	H mm	K mm		A	Z	ORDER NO. K1920
	22	19	2		30°	3	790.220.02

	L mm	H mm	K mm		A	Z	ORDER NO. K1920
	28	14	2		30°	2	790.280.00

	L mm	H mm	K mm	R mm	A	Z	ORDER NO. K1920
	16	22	5	1,5			790.161.00
	16	22	5	2			790.162.00
	16	22	5	3			790.163.00
	16	22	5		45°		790.160.00

	L mm	H mm	K mm	R mm	A	Z	ORDER NO. K1920
	19,5	9	1,5	2	35°	2	790.020.00
	19,5	9	1,5	3	35°	2	790.030.00
	19,5	9	1,5	5	35°	2	790.050.00
	24	12	1,5	6,4	35°	2	790.064.00
	24	12	1,5	8	35°	2	790.080.00

	L mm	H mm	K mm		A	Z	ORDER NO. DP
	30	12	1,5		35°	1	790.300.60*

*These knives are supplied in a 2 pc. case. Minimum 2 pieces or multiple of 2 piece order.

MATERIAL	K1920	K2250
Softwood	★★★★	
Hardwood	★★★★★	
Chipboard	★★★★★	★★★★★
MDF	★★★★★	★★★★★
HDF	★★★★★	★★★★★
Plastics	★★★	★★★★★
Solid Surface		★★★★★







TECHNICAL DETAILS:





















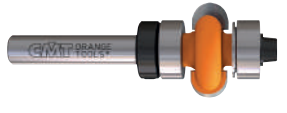

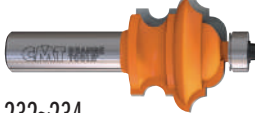





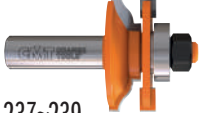

















K1920 Hardness (HV10): 1.920 - Transverse rupture strength (N/mm²): 2.600
New chrome grade for universal cutting applications. Excellent resistance to corrosion, oxidation and mechanical wear. High efficiency, 20% longer lifetime compared to standard grade.

K2250 Hardness (HV10): 2.250 - Transverse rupture strength (N/mm²): 2.400
New nano-grain grade for maximum wear resistance. Higher efficiency due to improved tool lifetime. Improved toughness.

All knives are supplied in a 10 pc. case.
Minimum 10 piece or multiple of 10 piece order.



<p>UP & DOWN CUT SPIRAL</p>  <p>170</p>	<p>Z1 UPCUT SPIRAL</p>  <p>170</p>	<p>Z2 UP & DOWN CUT SPIRAL</p>  <p>171</p>	<p>STRAIGHT WITH CENTER TIP</p>  <p>172</p>
<p>STRAIGHT</p>  <p>173-175</p>	<p>STRAIGHT WITH THREADED SHANK</p>  <p>176</p>	<p>SPIRAL FOR ALUMINIUM</p>  <p>177</p>	<p>STRAIGHT WITH INSERT KNIVES</p>  <p>178-179</p>
<p>MORTISING & HINGE</p>  <p>180-181</p>	<p>PATTERN</p>  <p>182</p>	<p>PATTERN WITH INSERT KNIVES</p>  <p>183</p>	<p>WEATHERSEAL</p>  <p>184</p>
<p>COMBINATION TRIMMER</p>  <p>184-185</p>	<p>COMBINATION TRIMMER WITH BEARING</p>  <p>185</p>	<p>FLUSH TRIM</p>  <p>186-187</p>	<p>SPIRAL FLUSH TRIM</p>  <p>188</p>
<p>FLUSH TRIM FOR LAMINATE</p>  <p>188</p>	<p>FLUSH TRIM WITH INSERT KNIVES</p>  <p>189</p>	<p>PATTERN/FLUSH WITH INSERT KNIVES</p>  <p>190</p>	<p>PATTERN/FLUSH TRIM</p>  <p>190</p>
<p>PANEL PILOT</p>  <p>191</p>	<p>RABBETING</p>  <p>192-194</p>	<p>RABBETING WITH INSERT KNIVES</p>  <p>193-194</p>	<p>KEYHOLE</p>  <p>195</p>
<p>T-SLOT</p>  <p>195</p>	<p>SCREW SLOT</p>  <p>196</p>	<p>SLOT FOR FLOORING</p>  <p>196</p>	<p>SLOT CUTTERS & SETS</p>  <p>197-199</p>
<p>LOCK MITER</p>  <p>200-201</p>	<p>GLUE JOINT</p>  <p>202</p>	<p>DRAWER LOCK</p>  <p>203</p>	
<p>WINDOW SASH</p>  <p>204</p>		<p>GLASS DOOR SASH</p>  <p>205</p>	
<p>V-TONGUE & GROOVE</p>  <p>207</p>		<p>EDGE BANDING</p>  <p>207</p>	
<p>FINGER JOINT</p>  <p>206</p>	<p>DOVETAIL</p>  <p>208-210</p>	<p>60° LETTERING</p>  <p>211</p>	<p>BOWL & TRAY</p>  <p>211</p>
<p>V-GROOVING & LASER POINT</p>  <p>212-214</p>	<p>CHAMFER</p>  <p>215-216</p>	<p>CHAMFER WITH INSERT KNIVES</p>  <p>215</p>	<p>ROUND NOSE</p>  <p>217</p>

BALL END  218	COVE  219-220	OVOLO & ROUNDOVER  220-223	ROUNDOVER WITH INSERT KNIVES  221
DECORATIVE BEADING  224-225	OGEE & PROFILES  226-227	ADJUSTABLE ROUNDOVER  228	WAINSCOT PANELING  229
CORNER BEADING  229-230	BEAD & BULL NOSE  230	EDGE-FLUTING  231	
MOULDING SYSTEM  231		MOULDING  232-234	FINGER PULL DOOR LIP  234-235
TABLE EDGE & HAND RAIL  236		VERTICAL RAISED PANEL  236	RAISED PANEL  240-241
RAIL & STILE SET  237-239		STILE & PANEL  242	STRIPLOX® CUTTER  243
SOLID SURFACE COUNTER-TOP TRIM  243	SOLID SURFACE ROUNDOVER  244-245	SOLID SURFACE BEVEL  246	SOLID SURFACE CUT & PLUG REPAIR SET  247
SOLID SURFACE WAVY JOINT  248	SOLID SURFACE NO-DRIP  250	SOLID SURFACE SINK & TRIM  249-250	ROUTER BIT SETS  251-261
STRAIGHT  263		FLUSH TRIM  264	ROUND NOSE  264
V-GROOVE  265		KEYHOLE  265	DOVETAIL  266
SLOT CUTTER  266		RABBETING  267	COVE  267
OVOLO  267		OGEE  268-269	ROUTER BIT SETS  269

CUTTING EDGE TYPE

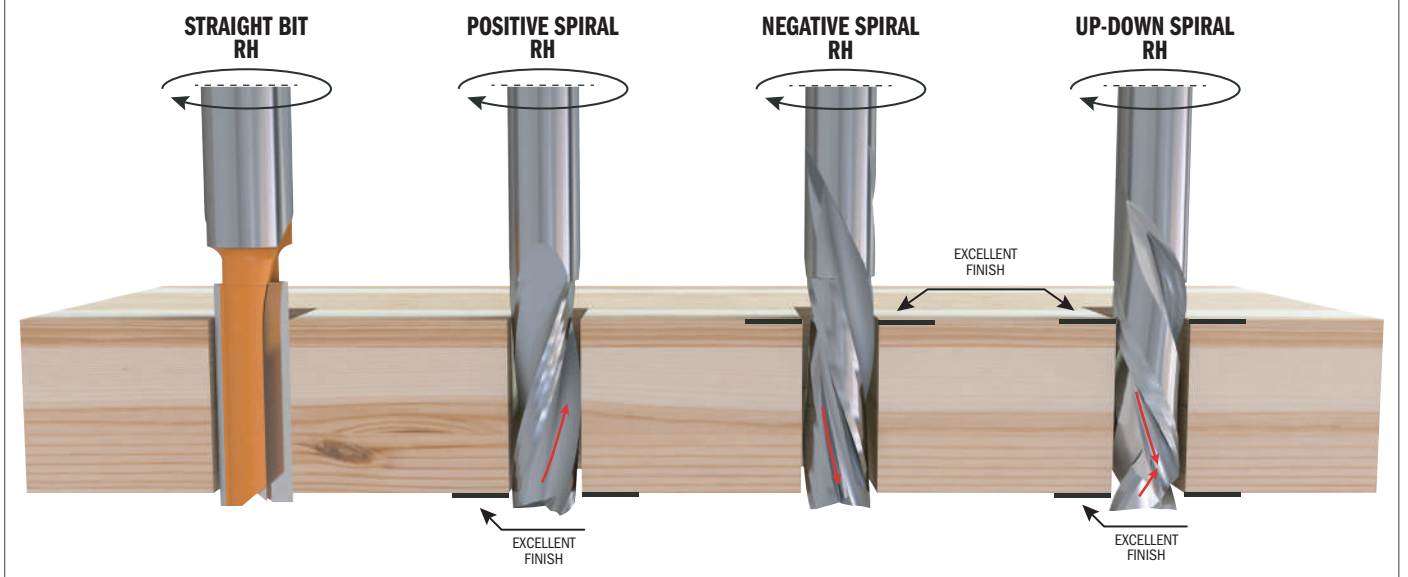

RECOMMENDED PLUNGING METHOD

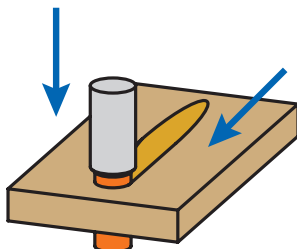

RAMP PLUNGING

These methods are recommended for sizing and grooving tools.

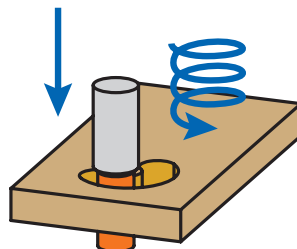

SPIRAL PLUNGING

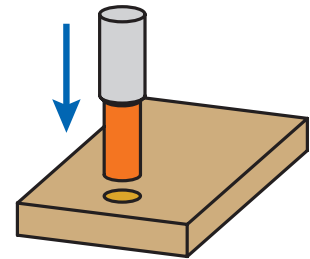

AXIAL PLUNGING

Router bits with mainly negative cutting shear angles, negative spiral, and router bits without plunging cutter are **NOT** suitable for axial plunging!

PROBLEM SOLVING

PROBLEM

Bad finishing
Cutting edge wear
Cutting edge burns
Cutting edge debris
Vibrations
Cutter breakage

SOLUTIONS

<ul style="list-style-type: none"> • Cutting depth • Vibrations
<ul style="list-style-type: none"> • Rotation speed • Vibrations
<ul style="list-style-type: none"> • Rotation speed • Number of cutting-edges
<ul style="list-style-type: none"> • Cutting depth
<ul style="list-style-type: none"> • Rotation speed • Cutting depth
<ul style="list-style-type: none"> • Feed speed • Cutting depth • Vibrations

INCREASE

<ul style="list-style-type: none"> • Rotation speed • Dust extraction • Number of cutting edges • Clamping cutter/chuck
<ul style="list-style-type: none"> • Feed speed
<ul style="list-style-type: none"> • Feed speed
<ul style="list-style-type: none"> • Rotation speed • Feed speed • Dust extraction
<ul style="list-style-type: none"> • Machine stability • Workpiece stability
<ul style="list-style-type: none"> • Shank diameter • Collet clamping • Change tool material (solid carbide or DENSIMET®)

DECREASE

WHAT'S THE SECRET TO FLAWLESS EDGE PROFILES WITH NO REWORK?

WOOD MAGAZINE **Best Overall**
WOOD'S CHOICE 1994 ROUTER BITS

CMT Overall Rating **10!**
 Top Performing Router Bits



**MULTI-AXIS GRINDING
 CREATES A 3X LONGER
 LASTING MIRROR FINISH**

Each cutting edge is precisely sharpened to the micron, in order to produce a cutting angle, which is razor sharp, yet extremely durable.



ANTI-KICKBACK DESIGN

Controls depth of cut and minimizes the chance of kickback, reducing your risk of injury.



**SINTERHIP
 HI-DENSITY INDUSTRIAL CHROME
 CARBIDE**

New process called SinterHIP (Hot Isostatic Pressing), helps prevent material failure and increases cutting life.



TRI-METAL BRAZING

Our Silver-Copper-Silver brazing protects the carbide tip when cutting harder wood or wood composites and reduces the chance of failed welds.



**NON-STICK
 ORANGE SHIELD
 COATING®**

Prevents bit from heating up, reduces pitch build-up, protects against corrosion and provides a longer bit life.



Deluxe packaging



**SUPERIOR
 HIGH-STRENGTH STEEL**

We use high-quality, solid bar stock sourced from Switzerland, which provides exceptional resistance to fatigue and abrasion.

BUILDING THE WORLD'S FINEST CUTTING TOOLS

We built our foundations and reputation for high quality tools on the craftsman-like manufacturing of boring bits and router bits. Times have changed and current technology has completely altered the industry. As a result, our facilities have been newly renovated and our equipment today represents the most advanced technology available on the market. This allows us to continue to manufacture cutting tools with the skill and care that we always have.

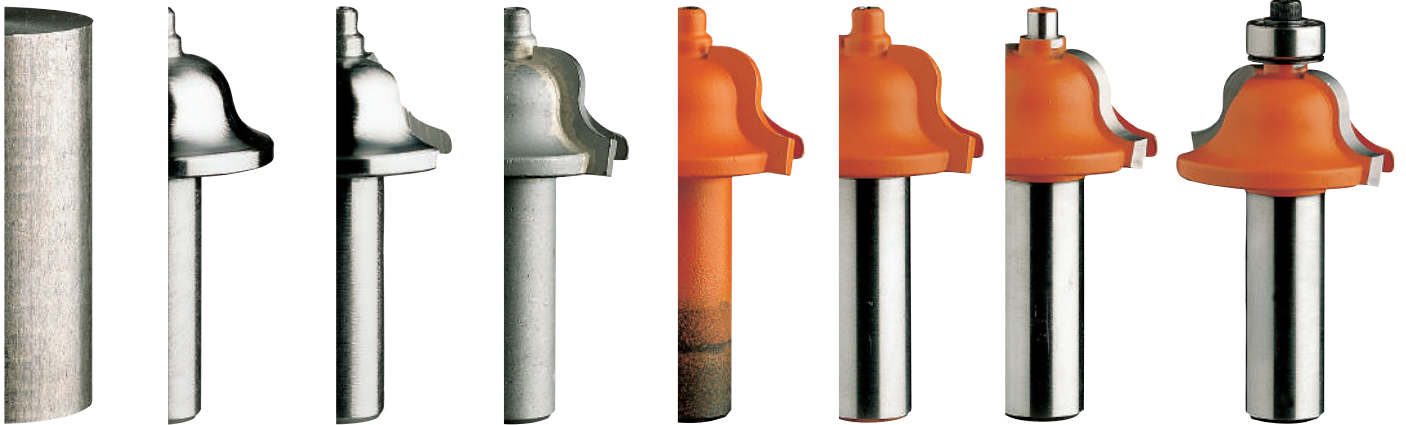

DESIGN

We engineer all of our products with a purpose in mind. Years of developing high performance cutting tools means that our top-sellers are tried and true, the result of continued perfection of each design, but we don't stop there: new materials, new profiles and new methods continue to emerge everyday.

At CMT, our objective is to remain on the cutting edge of innovation so our technical department ensures to continually monitor market developments, incorporate state-of-the-art software and apply experience in the sector to designs tools that are worthy of the CMT brand.

MATERIALS

Essentially, the main components of a router bit are just two: steel and carbide. If either of these is less than the best, the tool we make will show it. We've researched steel and carbide since the beginning, and found exactly what we were looking for:

Superior Steel. Our steel is comes from right above the border in Switzerland where an exclusive hot drawing process is applied to forge the solid bar stock we use to manufacture our shanks and bodies. The result? Steel that is superior in strength and exceptionally resistant to fatigue and abrasion.

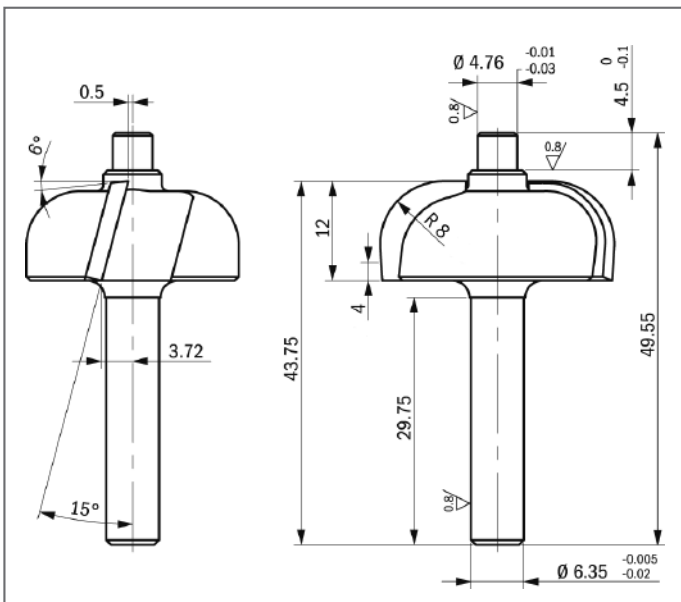

High-Grade Tungsten Carbide. If steel is what gives our tools strength, carbide is what gives them intelligence. The capacity of the carbide tip to cut precisely and to last a long time is critical for the performance of any tool, so at CMT we use only premium micrograin carbide from Luxembourg to make the tips for our router bits.

MANUFACTURING

Turning, Milling and Cutting. Our biggest investment in recent years has been in upgrading production. Today, all machinery at CMT is fully automated. CNC machines run by specially trained operators who make sure that the shanks and bodies of our router bits and boring bits are accurate and perfectly balanced.

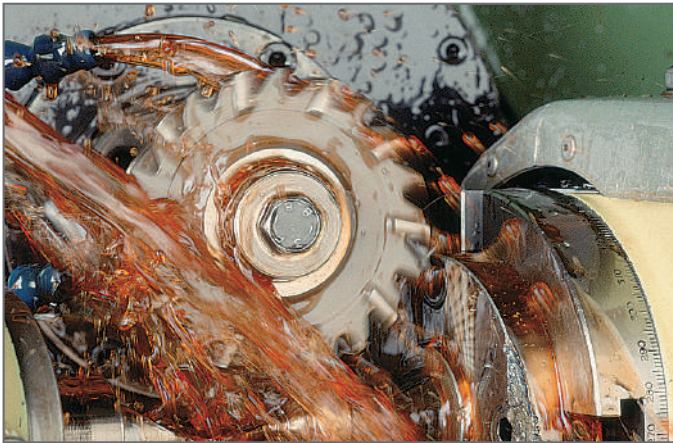

Heat Forged Steel Bodies for Large Diameter Bits. No router bits are exactly the same, sometimes not even in the way they are made. Certain bits require a few more steps than others, like heat forging the steel of larger diameter bits before turning it down into precise bit bodies. This extra step produces a radial grain orientation which gives large diameter bits extra strength and durability.

Brazing. We have pioneered the art of brazing. Not only does our unique custom-designed computerized brazing equipment help eliminate the inconsistencies found in old fashioned hand brazing, but our silver-copper-silver brazing 'sandwich' provides a tight bond between the steel and the carbide, with a shock absorbing effect to protect the carbide tips when cutting harder woods.

Specially Formulated Carbide for Specific Applications. You have to cut every kind material, so we make sure that our carbide tips can handle each individual job. This means specially formulating the carbide of each tool so that the compositions vary from being super hard (for tough cutting jobs like laminates) to being

less hard (to absorb the impact when cutting large profiles) and everything in between.

Grinding and Sharpening. The final step in the production process is no different from the rest: sharpening and grinding are done to extreme precision on multi-axis CNC machines. Each bevel and angle is ground or sharpened to the micron, to produce a cutting edge that is both razor sharp yet extremely durable.



680°C in seconds - and the brazing is complete.

QUALITY CONTROL

Even the simplest of tasks can include a margin for error. However at CMT, we take measures to prevent this. We always manually check the quality of our tools at each step of the manufacturing process, and we still make test cuts with rail & stile bits to make sure the cut fits. However, now we also use a fully automatic measuring process that evaluates every part of the tool without actually coming into contact with it, to make sure that the tool dimensions are accurate and that the profiles conform precisely to technical specification. We also use this system to gauge the wear and tear on the CNC machines.



CMT's fully automatic measuring system.

Solid Carbide Spiral Bits



Thanks to the spiral cutting edge which stays in continuous contact with the workpiece, these bits provide smoother, chatter-free cutting action, unlike conventional bits which have intermittent contact with the workpiece. Unsurpassed performance and cleaner cuts in ordinary or difficult materials, softwood, hardwood, plywood, composites etc. This new range of spiral bits with 6 - 8 - 12mm and 6,35 - 12,7mm shanks allow them to be used with a CNC router and hand-held routers. **Excellent quality-price ratio!**

**XTRME-
PERFORMANCE**

190.41 Upcut & Downcut Spiral - DLCS Chrome Coating



	D mm	I mm	I1 Pos. mm	L mm	Z		ORDER NO. S=Ø8mm	ORDER NO. S=Ø9,52mm	ORDER NO. S=Ø10mm	ORDER NO. S=Ø12mm	ORDER NO. S=Ø12,7mm
new	8	32	7	80	2+2	10	190.080.41				
	9,52	28,6	7	76,2	2+2	10		190.504.41			
new	10	32	7	80	2+2	10			190.100.41		
new	10	42	7	90	2+2	10			190.101.41		
	12	42	7	90	2+2	10				190.120.41	
	12	52	7	100	2+2	10				190.121.41	
	12,7	25,4	12	76,2	2+2	10					190.505.41
	12,7	28,6	12	76,2	2+2	10					190.506.41
	12,7	34,9	12	88,9	2+2	10					190.507.41
	12,7	41,3	12	101,6	2+2	10					190.508.41

Up & Downcut Mortising Bits

	9,52	22,2	4,8	76,2	2+2	10		190.513.41			
	9,52	25,4	5,2	76,2	3+3	10		190.813.41			
	12	25,4	5,2	83	3+3	10			190.320.41		
	12,7	22,2	5,2	76,2	2+2	10					190.515.41
	12,7	34,9	5,2	88,9	2+2	10					190.517.41
	12,7	28,5	6	76,2	3+3	10					190.815.41

190 Upcut & Downcut Spiral



	D mm	I mm	I1 Pos. mm	L mm	Z		ORDER NO. S=Ø6,35mm	ORDER NO. S=Ø8mm	ORDER NO. S=Ø9,52mm	ORDER NO. S=Ø10mm	ORDER NO. S=Ø12mm	ORDER NO. S=Ø12,7mm
	6,35	22,2	7	63,5	2+2	10	190.008.11					
	8	32	7	80	2+2	10		190.080.11				
	9,52	28,6	7	76,2	2+2	10			190.504.11			
	10	32	7	80	2+2	10				190.100.11		
	10	42	7	90	2+2	10				190.101.11		
	12	42	7	90	2+2	10					190.120.11	
	12	52	7	100	2+2	10					190.121.11	
	12,7	25,4	12	76,2	2+2	10						190.505.11
	12,7	28,6	12	76,2	2+2	10						190.506.11
	12,7	34,9	12	88,9	2+2	10						190.507.11
	12,7	41,3	12	101,6	2+2	10						190.508.11

Up & Downcut Mortising Bits

	9,52	22,2	4,8	76,2	2+2	10			190.513.11			
	9,52	25,4	5,2	76,2	3+3	10			190.813.11			
	12	25,4	5,2	83	3+3	10				190.320.11		
	12,7	22,2	5,2	76,2	2+2	10						190.515.11
	12,7	34,9	5,2	88,9	2+2	10						190.517.11
	12,7	28,5	6	76,2	3+3	10						190.815.11

198 Upcut



	D mm	I mm	L mm		ORDER NO. S=Ø6mm	ORDER NO. S=Ø6,35mm	ORDER NO. S=Ø8mm	ORDER NO. S=Ø12mm
	3,18	12,7	50,8	10		198.001.11		
	4,76	15,87	50,8	10		198.005.11		
	6	22	60	10	198.060.11			
	6,35	19,05	50,8	10		198.007.11		
	6,35	25,4	63,5	10		198.008.11		
	8	22	70	10			198.080.11	
	8	32	80	10			198.081.11	
	12	32	83	10				198.120.11





191 Upcut Spiral



D mm	I mm	L mm		ORDER NO. S=Ø6mm	ORDER NO. S=Ø6,35mm	ORDER NO. S=Ø8mm	ORDER NO. S=Ø12mm	ORDER NO. S=Ø12,7mm
3	12	60	10	191.630.11		191.830.11		
3,18	12,7	50,8	10		191.001.11			
3,5	12	60	10	191.635.11				
3,97	12,7	50,8	10		191.003.11			
4	15	60	10	191.640.11		191.840.11		
4,76	19,05	50,8	10		191.005.11			
5	17	60	10	191.650.11		191.850.11		
6	27	70	10	191.060.11		191.860.11		
6,35	19,05	50,8	10		191.007.11			
6,35	25,4	63,5	10		191.008.11			
7	32	80	10			191.870.11		
7,94	25,4	76,2	10					191.501.11
8	22	70	10			191.080.11		
8	32	80	10			191.081.11		
8	42	90	10			191.082.11		
9	32	83	10				191.890.11	
9,53	31,75	82,5	10					191.503.11
10	32	80	10			191.800.11		
10	32	83	10				191.900.11	
10	42	90	10				191.901.11	
12	35	83	10			191.820.11	191.120.11	
12	42	90	10				191.121.11	
12	52	100	10				191.122.11	
12,7	31,75	76,2	10					191.505.11
12,7	38,1	88,9	10					191.506.11
12,7	50,8	101,6	10					191.507.11



Excellent finish



192 Downcut Spiral



D mm	I mm	L mm		ORDER NO. S=Ø6mm	ORDER NO. S=Ø6,35mm	ORDER NO. S=Ø8mm	ORDER NO. S=Ø12mm	ORDER NO. S=Ø12,7mm
3	12	60	10	192.630.11		192.830.11		
3,18	12,7	50,8	10		192.001.11			
3,97	12,7	50,8	10		192.003.11			
4	15	60	10	192.640.11		192.840.11		
4,76	19,05	50,8	10		192.005.11			
5	17	60	10	192.650.11		192.850.11		
6	27	70	10	192.060.11		192.860.11		
6,35	19,05	50,8	10		192.007.11			
6,35	25,4	63,5	10		192.008.11			
7,94	25,4	76,2	10					192.501.11
8	22	70	10			192.080.11		
8	32	80	10			192.081.11		
8	42	90	10			192.082.11		
9,53	31,75	82,5	10					192.503.11
10	32	80	10			192.800.11		
10	32	83	10				192.900.11	
12	35	83	10			192.820.11	192.120.11	
12,7	31,75	76,2	10					192.505.11
12,7	38,1	88,9	10					192.506.11
12,7	50,8	101,6	10					192.507.11



Excellent finish



192.41 DLCS Chrome Coating Long Life



SEE PAGE 285

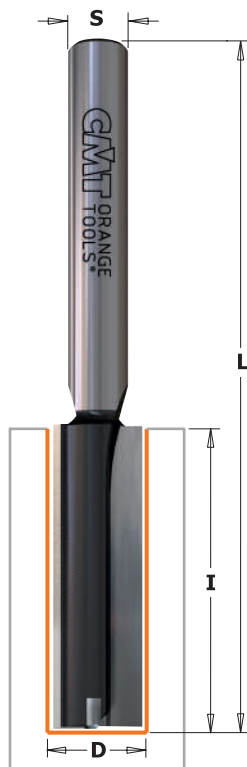

174 - 177 - 912

These industrial straight bits are made from stainless steel specifically created to withstand rigorous workloads on hand-held or CNC routers. The two lateral cutting edges allow you to execute any kind of plunge drilling and trimming jobs on solid, soft or hardwood, wood composite and plastic or laminated materials.

APPLICATION: - soft and hardwood and wood composite
- chipboard, MDF (laminat & melamine)
- plywood, veneer, ecc.

PLUNGE CENTRE TIP Z2+1

The special carbide-tipped cutting edge guarantees long-lasting performance compared to traditional bits.

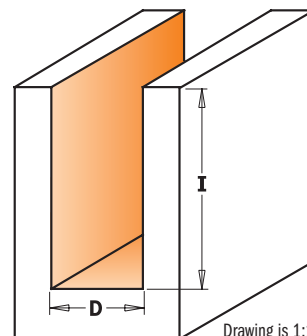
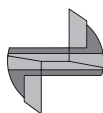

Drawing is 1:1 scale

177

D mm	I mm	L mm		ORDER NO. S=Ø12mm
10	35	90	10	177.100.11
12	35	90	10	177.120.11
12	50	100	10	177.121.11
14	35	90	10	177.140.11
16	35	90	10	177.160.11
16	60	110	10	177.161.11
18	35	90	10	177.180.11
18	60	110	10	177.181.11
20	35	90	10	177.200.11
22	35	90	10	177.220.11
24	35	90	10	177.240.11
25	35	90	10	177.250.11
26	35	90	10	177.260.11
28	35	90	10	177.280.11
30	35	90	10	177.300.11
35	35	90	10	177.350.11

912

D mm	I mm	L mm		ORDER NO. S=Ø12mm
12	70	110	10	912.623.11

Carefully make several shallow passes to prevent damaging the tool.
The warranty does not cover improper use of the tool.

PLUNGE CENTRE TIP Z2+1

The special carbide-tipped cutting edge guarantees long-lasting performance compared to traditional bits.

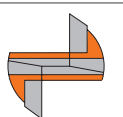

174

D mm	I mm	L mm		ORDER NO. S=Ø8mm
• 3	10	55	10	174.030.11
• 4	10	55	10	174.040.11
• 5	12	55	10	174.050.11
• 6	14	55	10	174.060.11
• 7	20	55	10	174.070.11
8	20	55	10	174.080.11
8	30	70	10	174.081.11
8	40	90	10	174.082.11
9	20	55	10	174.090.11
10	20	60	10	174.100.11
10	30	70	10	174.102.11
10	40	90	10	174.101.11
11	20	60	10	174.110.11
12	20	60	10	174.120.11
12	30	70	10	174.122.11
12	40	90	10	174.121.11
13	20	60	10	174.130.11
14	20	60	10	174.140.11
14	30	70	10	174.142.11
14	40	90	10	174.141.11
15	20	60	10	174.150.11
16	20	70	10	174.160.11
16	30	70	10	174.162.11
16	40	90	10	174.161.11
18	20	70	10	174.180.11
18	30	70	10	174.181.11
18	40	80	10	174.182.11
19	20	70	10	174.190.11
20	20	70	10	174.200.11
20	30	70	10	174.201.11
20	40	90	10	174.202.11
22	20	70	10	174.220.11
22	30	70	10	174.221.11
22	40	90	10	174.222.11
23,5	20	70	10	174.235.11
24	20	70	10	174.240.11
24	30	70	10	174.241.11
24	40	90	10	174.242.11
25	20	70	10	174.250.11
26	20	70	10	174.260.11
26	30	70	10	174.261.11
28	20	70	10	174.280.11
28	30	70	10	174.281.11
29	20	70	10	174.290.11
30	20	70	10	174.300.11
32	20	70	10	174.320.11

NEW

• HWM



7/8/912

SAFETY PRECAUTIONS: never use damaged or worn bits. Always work at the recommended proper feed rate without forcing the bit. Pay particular attention when making the initial cut with a small diameter bit. For best results when working with small diameter bits, make the cut in more than one pass.

The sharpened cutting edge is perfect for short plunging operations



Masterpack

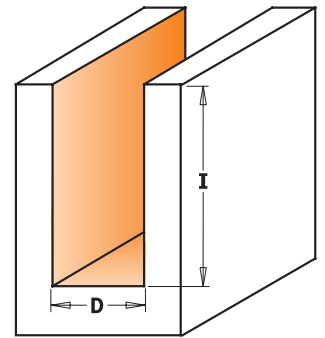

Drawing is 1:1 scale

• HWM

D mm	I mm	L mm		ORDER NO. S=Ø6mm	ORDER NO. S=Ø6,35mm	ORDER NO. S=Ø8mm	ORDER NO. S=Ø10mm	ORDER NO. S=Ø12mm	ORDER NO. S=Ø12,7mm
• 3	11	60	10	712.030.11					
• 3,2	12,7	50,8	10		812.032.11				
• 4	12	60	10	712.040.11					
• 5	18	60	10	712.050.11					
• 6	25,4	60	10	712.060.11	812.060.11	912.060.11			
• 6,35	25,4	60	10		812.064.11				
• 8	31,7	60	10	712.080.11	812.080.11	912.080.11			
• 8	31,7	75	10					912.580.11	
9	31,7	75	10					912.590.11	
9,5	31,7	63,5	10		812.095.11				
9,5	31,7	73	10						812.595.11
10	31,7	60	10	712.100.11	812.100.11	912.100.11			
10	31,7	70	10						812.600.11
10	31,7	74	10					912.600.11	
11,1	31,7	82,5	10						812.611.11
12	31,7	60	10	712.120.11	812.120.11	912.120.11			
12	31,7	70	10						812.620.11
12	38,1	95	10					912.621.11	812.621.11
12	50,8	108	10					912.622.11	
12,7	31,7	70	10		812.127.11	912.127.11			
12,7	38,1	95	10						812.627.11
12,7	50,8	108	10						812.628.11
12,7	63,5	111	10						812.629.11
14	31,7	60	10	712.140.11	812.140.11	912.140.11			
14	31,7	70	10					912.640.11	
15	31,7	66	10	712.150.11	812.150.11	912.150.11			
15	31,7	70	10					912.650.11	
15,8	31,7	70	10		812.158.11				
16	31,7	66	10	712.160.11	812.160.11	912.160.11			
16	31,7	70	10					912.660.11	812.660.11
18	38,1	80	10					912.681.11	
19	38,1	82,5	10					912.690.11	812.690.11
19	50,8	92	10					912.691.11	812.691.11
20	38,1	80	10					912.701.11	
22	38,1	80	10					912.721.11	
10 pc. masterpack									
6,35	25,4	60			812.064.11-X10				
12,7	50,8	108							812.628.11-X10

For Industrial Nesting Application [Z3] - DLCS Chrome Long-Life Coating

new	• 6	21	73	10				912.561.11	
new	• 6	26	73	10				912.560.11	
new	• 6,35	26	73	10					812.564.11
new	• 8	21	73	10				912.582.11	
new	• 8	28,7	76	10				912.581.11	812.581.11
new	• 8	32	76	10				912.583.11	
new	• 10	21	75	10			912.610.11		
new	• 10	32	75	10			912.611.11		

Straight Bits

HWM HW Z1 Z2 RH

7/8/911

If you are looking to get the most out of your time and money through more efficient production, but want nothing This double edged cutter is made of special FATIGUE-PROOF® steel and micrograin carbide to withstand even the heaviest of workloads. The surface is protected with our trademark orange non-stick P.T.F.E. coating to help keep the bit from collecting resin, pitch and other residue. Every bit is subject to strict quality tests to guarantee perfect cutting tolerance, balance and concentricity. You can also count on exceptional swarf removal to allow cleaner and more constant cutting. CMT bits are perfect for industrial scale production using a variety of materials such as plywood, composites and natural woods.



The sharpened cutting edge is perfect for short plunging operations.

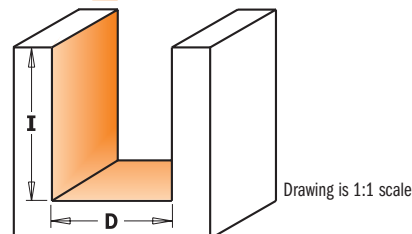

Drawing is 1:1 scale

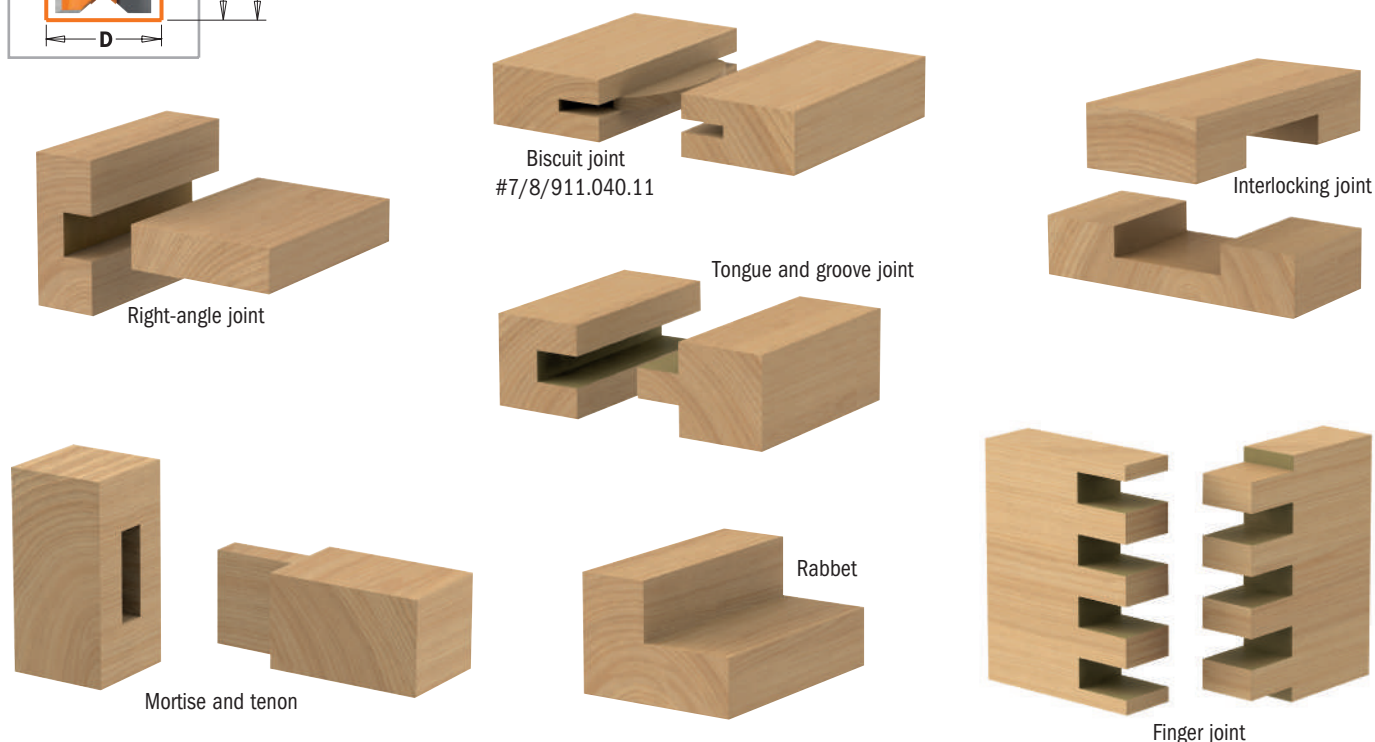

Plywood Groove Set

811

HWM HW Z2 RH

These groove bits are specifically designed to rout grooves and dados for joints in plywood. This means they match the true thickness of the material, producing tight, accurate joints. Use our 18.2mm bit for 19mm plywood, 12.3mm bit for 12.7mm plywood and our 6mm bit for 6.35mm plywood. No sloppy joints. No worries! These money-saving 3-bit sets are available with 12.7mm or 6.35mm shanks.



EXAMPLE SHOWN IN 12,7MM THICK PLYWOOD

This joint is made with the CMT 12,3mm straight bit for 12,7mm plywood. Notice the precise fit - no gaps.

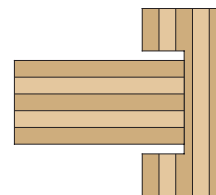
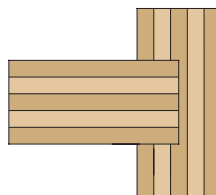

This joint is made with a regular 12,7mm straight bit for 12,7mm plywood. Notice the extra space and poor joint fit.

DESCRIPTION		ORDER NO. S=Ø6,35mm	ORDER NO. S=Ø12,7mm
Plywood Groove Set (Ø6 - Ø12,3 - Ø18,2mm)	5	811.001.11	811.501.11

D mm	I mm	L mm		ORDER NO. S=Ø6mm	ORDER NO. S=Ø6,35mm	ORDER NO. S=Ø8mm	ORDER NO. S=Ø12mm	ORDER NO. S=Ø12,7mm
• 2*	4	45	10	711.020.11	811.020.11			
• 3	8	45	10	711.030.11	811.030.11			
• 3	8	50	10			911.030.11		
• 3	8	58,3	10				911.530.11	
• 3,2	9,5	45	10		811.032.11			
• 4	10	58,3	10				911.540.11	
• 4	10	45	10	711.040.11	811.040.11			
• 4	10	50	10			911.040.11		
• 4,75	12,7	50,8	10		811.047.11			
• 5	12	50	10	711.050.11	811.050.11	911.050.11		
• 5	12	58,3	10				911.550.11	
• 6	16	50	10	711.060.11	811.060.11	911.060.11		
• 6	19	63,5	10				911.560.11	811.560.11
• 6,35	19	50,8	10		811.064.11			
• 6,35	19	57,2	10		811.065.11			
• 6,35	19	63,5	10					811.564.11
• 7	18	49	10	711.070.11	811.070.11	911.070.11		
• 7	18	63,5	10				911.570.11	
• 7,6	20	50	10			911.076.11		
• 8	20	50	10	711.080.11	811.080.11	911.080.11		
• 8	25,4	70	10		811.081.11			
• 8	25,4	70	10					811.581.11
9	20	48	10	711.090.11		911.090.11		
9,5	19	50,8	10		811.095.11			
9,5	25,4	63,5	10		811.096.11			
9,5	25,4	66,7	10					811.595.11
10	20	48	10	711.100.11	811.100.11	911.100.11		
10	25,4	63,5	10					811.600.11
11	20	48	10	711.110.11		911.110.11		
12	20	50	10	711.120.11	811.120.11	911.120.11		
12	25,4	63,5	10				911.620.11	811.620.11
12,3	25,4	57,2	10		811.123.11			
12,3	25,4	63,5	10					811.623.11
12,7	19	57,2	10		811.127.11			
12,7	25,4	66,7	10					811.627.11
12,7	31,7	76,2	10					811.628.11
13	20	57	10	711.130.11		911.130.11		
14	20	50	10	711.140.11	811.140.11	911.140.11		
14,2	14,2	57,2	10		811.142.11			
15	20	57,2	10	711.150.11	811.150.11	911.150.11		
15,8	19	66,7	10		811.158.11			
15,8	25,4	63,5	10					811.660.11
16	20	57,2	10	711.160.11	811.160.11	911.160.11		
16	25,4	63,5	10					811.661.11
17	20	50	10	711.170.11				
18	20	50	10	711.180.11	811.180.11	911.180.11		
18,2	25,4	57,2	10		811.182.11			
18,2	25,4	63,5	10					811.682.11
19	20	57,2	10	711.190.11	811.191.11	911.190.11		
19	25,4	63,5	10					811.690.11
19,85	25,4	59	10					811.700.11
20	20	50	10	711.200.11	811.200.11	911.200.11		
22	20	57,2	10	711.220.11	811.220.11	911.220.11		
24	20	50	10	711.240.11		911.240.11		
25	20	50	10	711.250.11		911.250.11		
25,4	19	50,8	10		811.254.11			
25,4	31,7	76,2	10					811.754.11
28,5	31,7	76,2	10					811.785.11

• HWM

* Z1

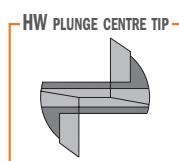
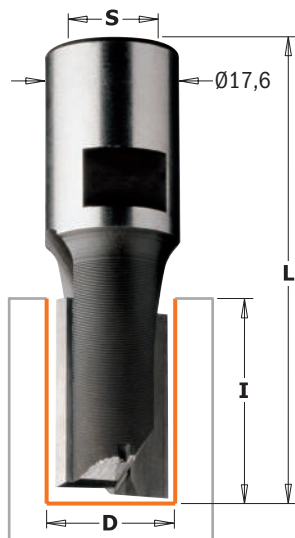

TECHNICAL DETAILS:

- Super strength steel
- 2 HW alternating precision ground cutting edges [Z2+1]

APPLICATION: ideal for groovework in solid wood, wood composites and laminates. Can be used on machining centres, CNC routers and hand-held routers equipped with chucks or adapters.

170 - 171 - 180 - 181

D mm	I mm	L mm		ORDER NO. S=M12x1
6	18	60	1	170.060.11
8	23	60	1	170.080.11
10	23	60	1	170.100.11 ■
11	23	60	1	170.110.11
12	23	60	1	170.120.11
14	23	60	1	170.140.11
15	25	60	1	170.150.11
16	25	60	1	170.160.11
18	25	60	1	170.180.11
20	25	60	1	170.200.11
22	25	60	1	170.220.11
24	25	60	1	170.240.11
25	25	60	1	170.250.11
26	25	60	1	170.260.11
28	25	60	1	170.280.11
30	25	60	1	170.300.11
35	25	60	1	170.350.11
8	35	67	1	171.080.11
10	35	67	1	171.100.11
12	35	67	1	171.120.11
14	35	67	1	171.140.11
16	35	67	1	171.160.11
18	35	67	1	171.180.11
20	35	67	1	171.200.11
22	35	67	1	171.220.11
12	45	77	1	180.120.11
16	45	77	1	180.160.11
18	45	77	1	180.180.11
20	45	77	1	180.200.11
16	60	92	1	181.160.11
20	60	92	1	181.200.11

■ Until stock last

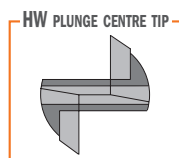
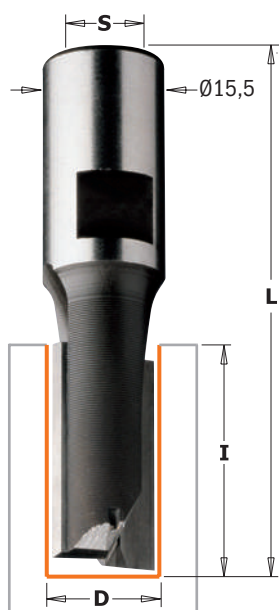

173 - 182



D mm	I mm	L mm		ORDER NO. S=M10x1,5
6	14	50	1	173.060.11
8	20	52	1	173.080.11
10	22	52	1	173.100.11
12	22	52	1	173.120.11
14	25	52	1	173.140.11
15	25	52	1	173.150.11
16	25	52	1	173.160.11
18	25	52	1	173.180.11
20	25	52	1	173.200.11
22	25	52	1	173.220.11
25	25	52	1	173.250.11
30	25	52	1	173.300.11
8	35	67	1	182.080.11
10	35	67	1	182.100.11
12	35	67	1	182.120.11
14	35	67	1	182.140.11
16	45	77	1	182.160.11
18	45	77	1	182.180.11
20	45	77	1	182.200.11

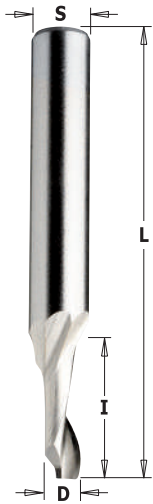

188

HSS Z1 RH

D mm	I mm	L mm		ORDER NO. S=Ø8mm
3	12	60	50	188.030.51
4	12	60	50	188.040.51
4	40	100	1	188.041.51
5	14	60	50	188.050.51
5	40	100	1	188.051.51
6	14	60	50	188.060.51
6	40	100	1	188.061.51
7	14	60	50	188.070.51
8	14	80	50	188.080.51
8	40	100	1	188.081.51
9	14	80	50	188.090.51
10	14	80	50	188.100.51
12	14	80	50	188.120.51

Suggested **MAX RPM 12.000**

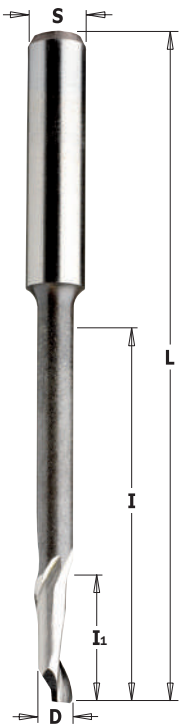

189 5% Co HSS Spiral Bits for High Cutting Depth

HSS Z1 RH

D mm	I mm	I1 mm	L mm	S mm		ORDER NO.
4	46	16	90	8	1	189.040.51
5	35	18	80	8	50	189.050.51
5	35	14	120	8	1	189.051.51
5	55	16	90	8	1	189.052.51
6	45	16	90	8	1	189.060.51
8	68	14	100	8	1	189.080.51
8	55	14	80	8	50	189.081.51
10	95	14	120	10	1	189.100.51
10	70	30	100	10	1	189.101.51

Suggested **MAX RPM 12.000**

TECHNICAL DETAILS:

- 5% Co premium solid HSS
- 1 upcut spiral cutting edge
- Upward chip ejection

APPLICATION: for **plunging, routing and trimming** aluminium profiles, plastics with superb efficiency and high feed speed. Can be used on machining centres, aluminium copy routers, CNC and hand-held routers equipped with chucks or adapters.



Solid Carbide Upcut Spiral Bits for Aluminium and PVC

186

MIRROR FINISH HWM Z2 RH

D mm	I mm	L mm	S mm		ORDER NO. Right-hand rotation
4	10	60	6	10	186.640.11
5	12	60	6	10	186.650.11
6	15	60	6	10	186.060.11
8	20	60	8	10	186.080.11
10	22	72	10	10	186.100.11
12	25	83	12	10	186.120.11
14	25	82	14	10	186.140.11
16	25	82	16	10	186.160.11

* with seat for seeger retention ring

TECHNICAL DETAILS:

- Premium quality HWM
- 2 spiral cutting edges [Z2]
- Extra-fine finish
- Upward chip ejection

APPLICATION: used for **plunging, routing and trimming** on plastic and aluminum at high feed speed. Can be used on machining centers, point to point machines, CNC routers and hand held routers equipped with chucks

Straight Router Bits with Insert Knives



Drawing is 1:1 scale

651 - 652

Straight router bit with one replaceable mini knife and fixing wedge. Radial and axial groove for better and safe knife insertion. For finishing, routing and grooving in board materials (DTD laminated, MDF and hardwood). For use on portable routers or CNC machining centres.

SAFETY TIPS:



The **TW-006** Torque Screwdriver is recommended for the proper fastening of screws (see page 406).

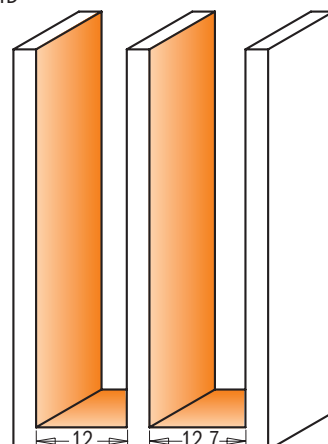
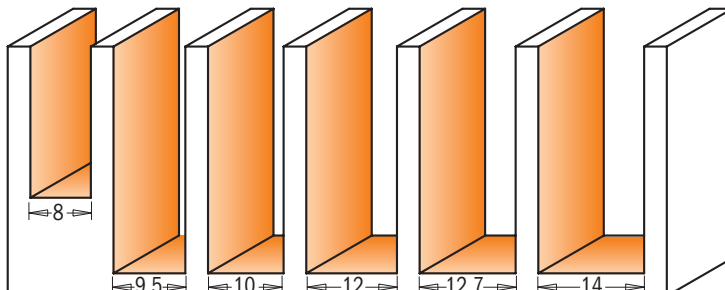
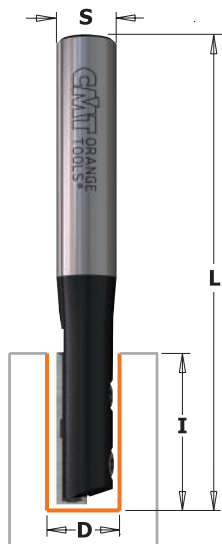

D mm	I mm	L mm		ORDER NO. S=Ø6,35mm	ORDER NO. S=Ø8mm	ORDER NO. S=Ø12mm	ORDER NO. S=Ø12,7mm	Spare parts							
8	20	60	10	651.079.11								790.200.01	651.999.01	990.070.00	991.063.00
8	20	60	10		651.080.11							790.200.01	651.999.01	990.070.00	991.063.00
8	20	67	10			651.081.11	651.681.11					790.200.01	651.999.01	990.070.00	991.063.00
9,5	30	80	10				651.695.11					790.300.01	651.999.02	990.071.00	991.063.00
10	30	70	10		651.100.11							790.300.01	651.999.02	990.071.00	991.063.00
10	30	80	10			651.101.11	651.701.11					790.300.01	651.999.02	990.071.00	991.063.00
12	30	70	10			651.120.11						790.300.01	651.999.02	990.071.00	991.063.00
12	30	80	10				651.721.11					790.300.01	651.999.02	990.071.00	991.063.00
12	30	80	10				652.121.11	652.621.11				790.500.01	651.999.03	990.016.00	991.060.00
12,7	50	103	10	651.127.11								790.300.01	651.999.02	990.071.00	991.063.00
12,7	30	70	10				651.727.11					790.300.01	651.999.02	990.071.00	991.063.00
12,7	30	80	10				652.628.11					790.300.01	651.999.02	990.071.00	991.063.00
12,7	50	103	10									790.500.01	651.999.03	990.016.00	991.060.00
14	30	73	10		651.140.11							790.300.01	651.999.02	990.071.00	991.063.00

Straight Router Bits with Insert Knives for Laminates



652

Straight trimmer bits with one replaceable knife fixed by a TORX® screw. A smart economical solution best suited for specialized applications requiring low downtime. The 29.5x9x1.5mm knives provide a 40mm cutting length by making multiple passes. For routing trimming and grooving on board materials (laminated chipboard, worktop panels and MDF). For use on portable routers.

SAFETY TIPS:



The **TW-006** Torque Screwdriver is recommended for the proper fastening of screws (see page 406).

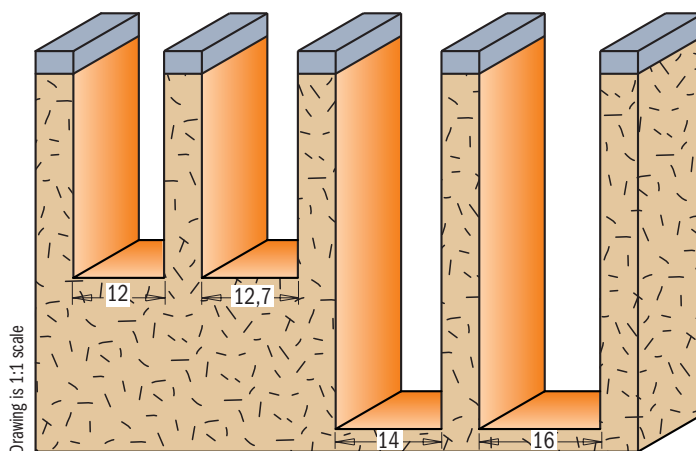
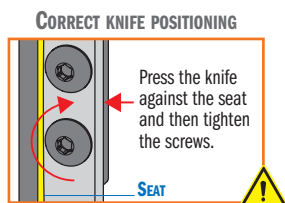

D mm	I mm	L mm		ORDER NO. S=Ø8mm	ORDER NO. S=Ø12mm	ORDER NO. S=Ø12,7mm	Spare parts		
12	29,5	79	10	652.120.11					
12	39,5	90	10	652.122.11			790.295.09	990.072.00	991.061.00
12,7	29,5	89	10			652.627.11	790.395.09	990.072.00	991.061.00
14	50	96	10		652.141.11		790.295.09	990.072.00	991.061.00
16	50	96	10		652.161.11		790.500.09	990.072.00	991.061.00
							790.500.09	990.072.00	991.061.00

Straight Router Bits with Insert Knives



653

Straight router bits with a replaceable plunging knife and side knife fixed by a special TORX® screw. The tool bodies are precisely balanced. For finishing, routing, plunging and grooving on board materials (laminated chipboards and MDF) and hardwood. For use on portable routers or CNC machining centres.

SAFETY TIPS:



The **TW-006** Torque Screwdriver is recommended for the proper fastening of screws (see page 406).

CORRECT KNIFE POSITIONING

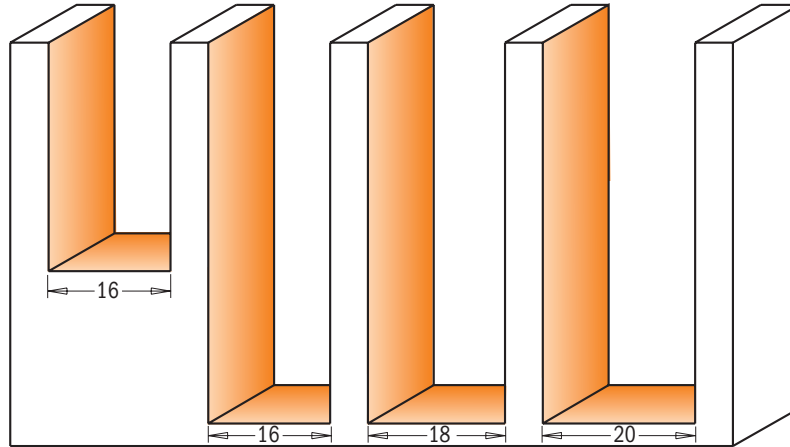
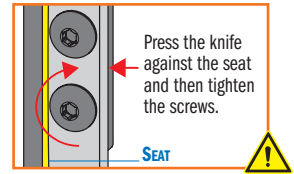

Drawing is 1:1 scale

D mm	I mm	L mm		ORDER NO. S=Ø8mm	ORDER NO. S=Ø12mm	ORDER NO. S=Ø12,7mm	ORDER NO. S=Ø20mm	Spare parts					
15,8	28,3	92	10			653.158.11							
16	28,3	82	10	653.160.11				790.283.12	990.074.00	990.075.00	790.075.00	990.072.00	991.061.00
16	28,3	92	10		653.161.11		653.661.11	790.283.12	990.074.00	990.075.00	790.075.00	990.072.00	991.061.00
16	48,3	111,5	10		653.162.11		653.662.11	790.483.12	990.074.00	990.075.00	790.075.00	990.072.00	991.061.00
18	48,3	111,5	10				653.681.11	790.483.12	990.074.00	990.075.00	790.075.00	990.072.00	991.061.00
20	48,3	111,5	10				653.701.11	790.483.12	990.074.00	990.075.00	790.096.00	990.072.00	991.061.00

Straight Router Bits with Insert Knives



655



654



For finishing, routing, plunging and grooving on board materials (laminated chipboards and MDF) and hardwood. For use on portable routers, **point to point**, or CNC centres.

SAFETY TIPS:



The **TW-006** Torque Screwdriver is recommended for the proper fastening of screws (see page 406).

CORRECT KNIFE POSITIONING

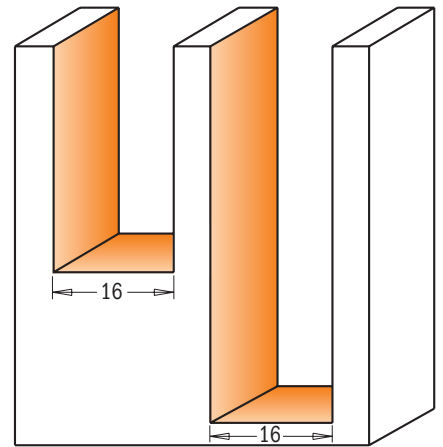
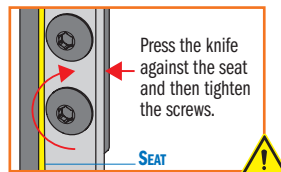

Drawing is 1:1 scale

D mm	I mm	L mm		ORDER NO. S=Ø8mm	ORDER NO. S=Ø12mm	ORDER NO. S=Ø12,7mm	ORDER NO. S=Ø20mm	Spare parts		
16	28,3	76	10	654.160.11						
16	28,3	87	10		654.161.11	654.661.11		790.283.12	990.073.00	991.061.00
16	48,3	105	10		654.162.11		654.662.11	790.283.12	990.073.00	991.061.00
19	12	45	10	655.190.11				790.483.12	990.073.00	991.061.00
								790.120.00	990.075.00	991.061.00

Mortising Bits



7/8/901B

Perfectly mortised hinges are the sign of a true artisan. These bits equipped with thick Tungsten carbide tips and negative shear angle design, guarantee flawless performance. Mortise perfect hinges with no splintered edges or rough bottoms. Mortising is a breeze on both natural wood and wood composites. Compatible with most mortising jigs. Complete with a top bearing guide, these bits are the perfect tool for sign making and template work.

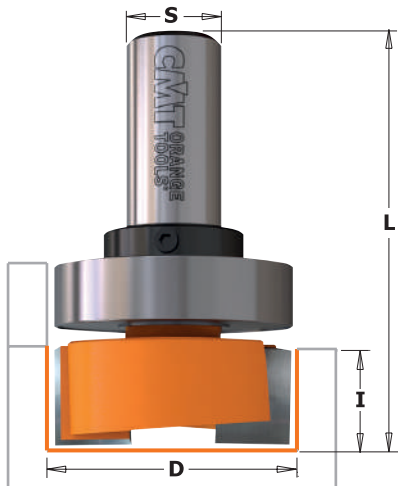

The CMT mortising bit is an essential tool for traditional hinge installation.

7/8/901

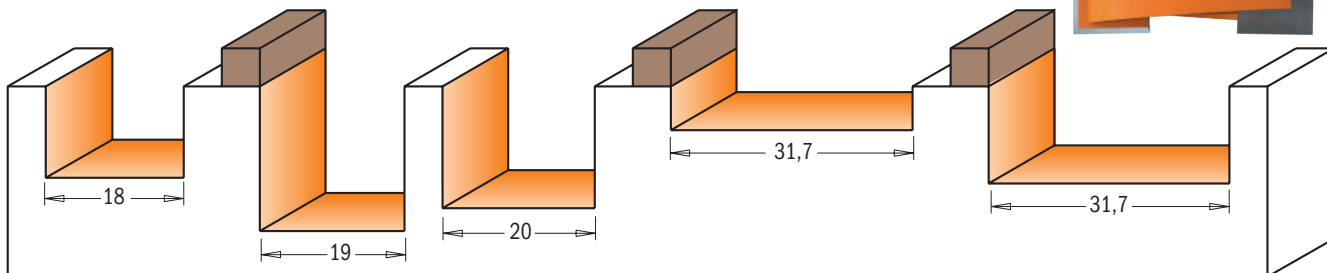
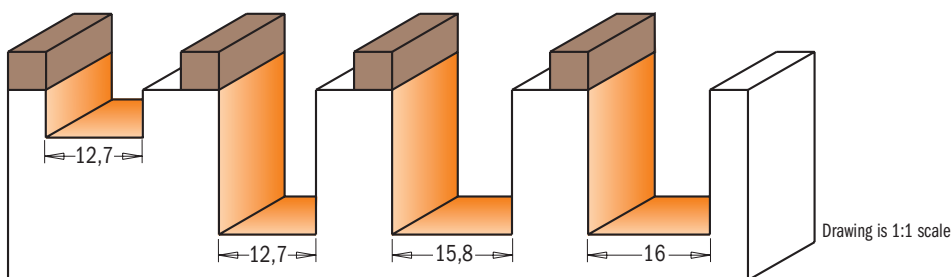

D mm	I mm	L mm		ORDER NO. S=Ø6mm	ORDER NO. S=Ø6,35mm	ORDER NO. S=Ø8mm	ORDER NO. S=Ø12mm	ORDER NO. S=Ø12,7mm
12,7	6,35	41	10		801.128.11			
12,7	19	54	10	701.127.11	801.127.11	901.127.11		
12,7	19	60	10				901.627.11	801.627.11
15,8	19	57	10		801.158.11			
16	19	54	10	701.160.11		901.160.11		
18	16	48	10	701.180.11		901.180.11		
19	19	54	10	701.190.11	801.190.11	901.190.11		
19	19	57	10					801.690.11
20	16	48	10	701.200.11		901.200.11		
31,7	5,7	63	10					801.818.11
31,7	12,7	48	10		801.317.11			
31,7	12,7	54	10				901.817.11	801.817.11
With top bearing								
12,7	6,35	41	10		801.128.11B			
12,7	19	54	10		801.127.11B			
15,8	19	57	10		801.158.11B			
16	19	54	10			901.160.11B		
19	19	54	10	701.190.11B				
19	19	54	10		801.190.11B			
31,7	5,7	63	10					801.818.11B
31,7	12,7	54	10					801.817.11B

Spare parts		
791.010.00	541.001.00	991.056.00
791.010.00	541.001.00	991.056.00
791.009.00	541.001.00	991.056.00
791.025.00	541.004.00	991.056.00
791.007.00	541.003.00	991.056.00
791.004.00	541.001.00	991.056.00
791.015.00	541.002.00	991.056.00
791.015.00	541.002.00	991.056.00

Hinge Recesser Bits

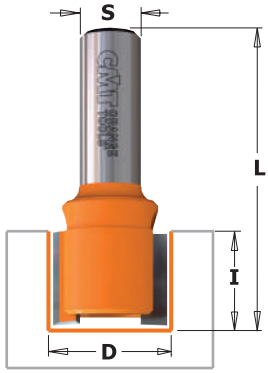

7/902

CMT hinge recesser bits are ideal for shallow lateral routing cuts such as recessing hinges.

SHOP TIPS: corners will require final square with a hand or a corner chisel.

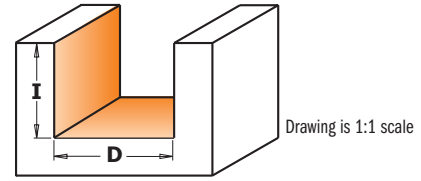

Drawing is 1:1 scale

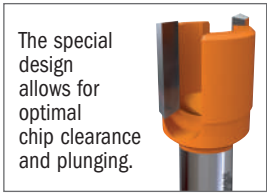

D mm	I mm	L mm		ORDER NO. S=Ø6mm	ORDER NO. S=Ø8mm
12	12	38	10	702.120.11	902.120.11
13	12	38	10	702.130.11	902.130.11
14	12	38	10	702.140.11	902.140.11
15	12	38	10	702.150.11	902.150.11
16	12	38	10	702.160.11	902.160.11
18	12	38	10	702.180.11	902.180.11
20	11	38	10	702.200.11	902.200.11
22	11	38	10	702.220.11	902.220.11
23	11	38	10	702.230.11	902.230.11
24	11	38	10	702.240.11	902.240.11
25	11	38	10	702.250.11	902.250.11

Dado & Planer Bits

852B



852

This bit is perfect for smoothing baseboard and rough surfaces. Tungsten carbide tips and downward shear angle provide exceptional performance and quality. This bit can be used to remove paint and enamel residues. Also available with bearing for projects requiring high precision.

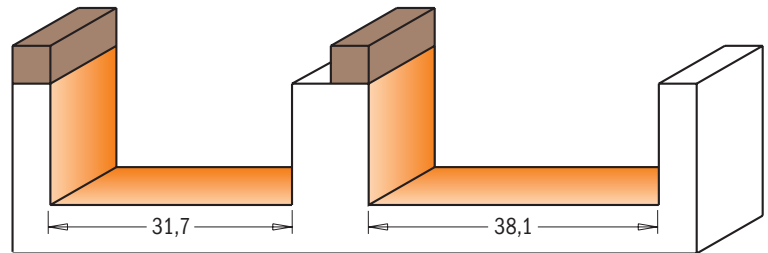
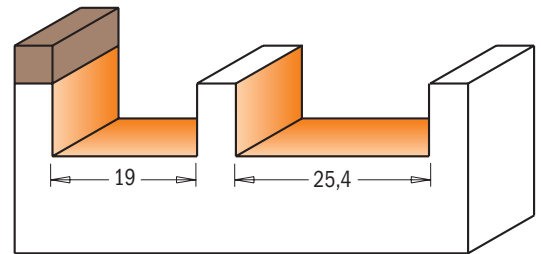

Drawing is 1:1 scale

D mm	I mm	L mm		ORDER NO. S=Ø6,35mm	ORDER NO. S=Ø8mm	ORDER NO. S=Ø12mm	ORDER NO. S=Ø12,7mm
19	9,5	57	10	852.001.11			
19	9,5	63,5	10				852.501.11
25,4	9,5	57	10				852.502.11
31,7	15,8	70	10				852.503.11
38,1	15,8	70	10				852.504.11
With top bearing							
19	9,5	57	10	852.001.11B			
19	9,5	57	10		952.001.11B		
19	9,5	63,5	10			952.501.11B	852.501.11B
31,7	15,8	70	10			952.503.11B	852.503.11B
38,1	15,8	70	10			952.504.11B	852.504.11B

Spare parts

791.004.00	541.001.00	991.056.00
791.034.00	541.004.00	991.056.00
791.011.00	541.002.00	991.056.00
791.015.00	541.002.00	991.056.00
791.020.00	541.002.00	991.056.00

new
new
new
new

Pattern Bits

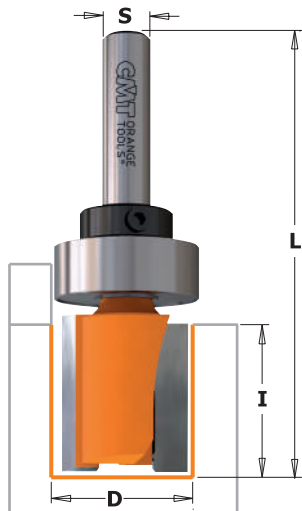

7/8/911B

These double-fluted bits paired with the template of your choice will produce distinctive cabinets, furniture pieces, signs, toys and personalize a variety of creative projects.

SAFETY TIPS: make sure your router is in top condition. The template must be securely fastened to the workpiece. When choosing a bit, carefully consider the thickness of the template and all the implications of the cut. Opt for the shortest bit possible for the project you are working on.

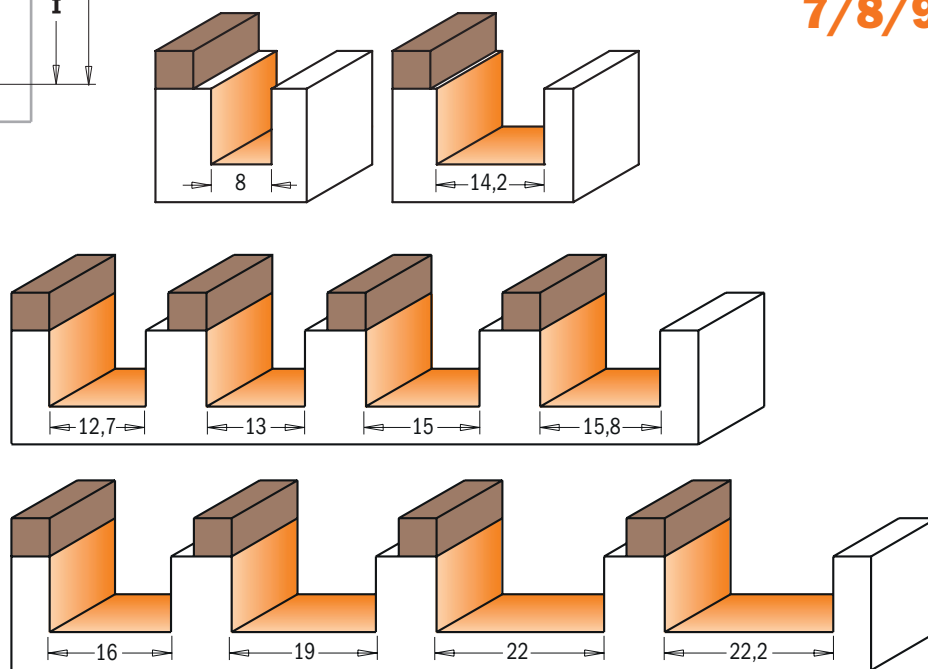

Drawing is 1:1 scale

7/8/912B



D mm	I mm	L mm		ORDER NO. S=Ø6mm	ORDER NO. S=Ø6,35mm	ORDER NO. S=Ø8mm	ORDER NO. S=Ø12mm	ORDER NO. S=Ø12,7mm
8	25,4	70	10		811.081.11B			
12,7	19	57,2	10		811.127.11B			
13	20	57	10	711.130.11B				
14,2	14,2	57,2	10		811.142.11B			
15	20	57	10	711.150.11B				
15,8	12,7	58	10		811.159.11B			
15,8	19	66,5	10		811.158.11B			
16	20	57	10			911.160.11B		
19	20	57	10	711.190.11B				
19	20	57,2	10		811.191.11B			
19	25,4	63,5	10					811.690.11B
22	20	57	10			911.220.11B		
22,2	25,4	66,5	10					811.222.11B*
Long series								
12,7	31,7	70	10		812.127.11B			
15	31,7	66,5	10	712.150.11B				
15,8	31,7	70	10		812.158.11B			
16	31,7	66,5	10			912.160.11B		
19	38,1	82,5	10				912.690.11B	
19	38,1	82,5	10					812.690.11B
19	50,8	92	10				912.691.11B	
19	50,8	92	10					812.691.11B

Spare parts

791.010.00	541.001.00	991.056.00
791.010.00	541.001.00	991.056.00
791.023.00	541.003.00	991.056.00
791.009.00	541.001.00	991.056.00
791.024.00	541.003.00	991.056.00
791.009.00	541.001.00	991.056.00
791.009.00	541.001.00	991.056.00
791.009.00	541.001.00	991.056.00
791.025.00	541.004.00	991.056.00
791.007.00	541.003.00	991.056.00
791.004.00	541.001.00	991.056.00
791.011.00	541.002.00	991.056.00
791.005.00	541.004.00	991.056.00
791.021.00	541.006.00	991.056.00
791.010.00	541.001.00	991.056.00
791.024.00	541.003.00	991.056.00
791.009.00	541.001.00	991.056.00
791.025.00	541.004.00	991.056.00
791.011.00	541.005.00	991.056.00
791.011.00	541.002.00	991.056.00
791.011.00	541.005.00	991.056.00
791.011.00	541.002.00	991.056.00

This item requires a slightly larger bearing than its cutting diameter

*Ø9,5mm shanks with Ø9,5/12,7mm bushings (799.001.00)

Pattern Router Bits with Insert Knives

652B

INSERT CARBIDE Z1 Z2 RH  2X CUTTING

Straight router bits with a replaceable knife fixed by a TORX® screw. An economical solution for specialized applications requiring low downtime. Cut up to 40mm in depth by carrying out several passes. Equipped with top bearing for template use. For routing, trimming and grooving in board materials (laminated chipboards, MDF) and hardwood. For use on portable routers.

SAFETY TIPS:



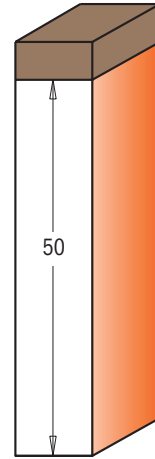
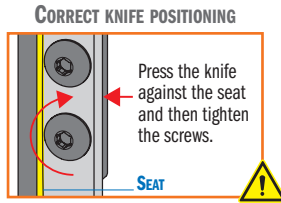



 The **TW-006** Torque Screwdriver is recommended for the proper fastening of screws (see page 406).

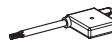

Drawing is 1:1 scale

D mm	I mm	L mm	Z		ORDER NO. S=Ø12mm	ORDER NO. S=Ø12,7mm
19	49,5	100	1	10	652.690.11B	652.691.11B
28	50	100	2	10	652.786.11B	
28,6	50	100	2	10		652.787.11B

Spare parts

					
790.495.09	990.072.00	991.061.00	791.011.00	541.002.00	991.056.00
790.503.00*	990.076.00	991.061.00	791.026.00	541.005.00	991.056.00
790.503.00*	990.076.00	991.061.00	791.027.00	541.002.00	991.056.00

* 3 bore

Pattern Router Bits with Insert Knives for Laminates

656

INSERT CARBIDE Z2 RH  2X CUTTING

Straight router bits with a replaceable knife fixed by a TORX® screw. The top knife features a 3° sharpened angle for plunge and high precision cuts. Equipped with top bearing for template use. For finishing, routing and grooving in board materials (laminated chipboards, MDF) and hardwood. For use on portable routers.

SAFETY TIPS:



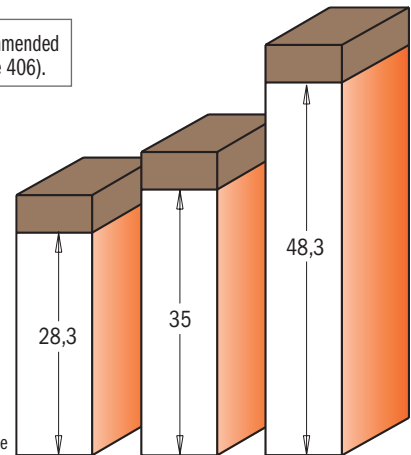
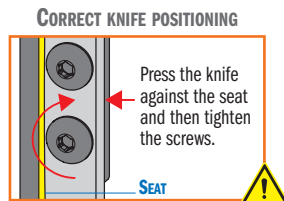
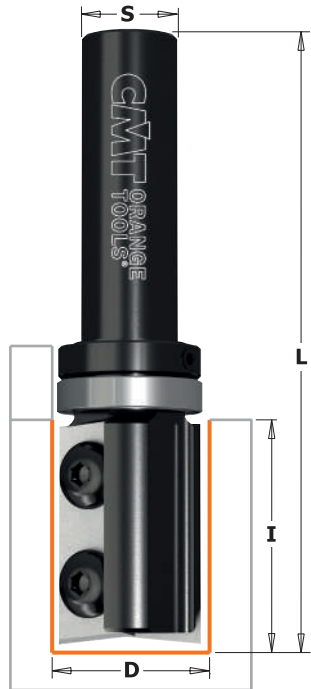



 The **TW-006** Torque Screwdriver is recommended for the proper fastening of screws (see page 406).

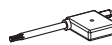

Drawing is 1:1 scale

D mm	I mm	L mm		ORDER NO. S=Ø8mm	ORDER NO. S=Ø12mm	ORDER NO. S=Ø12,7mm
16	35	80	10	656.160.11		
19	28,3	69	10	656.190.11		
19	28,3	79	10			656.691.11
19	48,3	100	10		656.692.11	656.693.11

Spare parts

					
790.283.12	990.076.00	991.061.00	791.025.00	541.004.00	991.056.00
790.283.12	990.075.00	991.061.00	791.034.00	541.004.00	991.056.00
790.283.12	990.075.00	991.061.00	791.011.00	541.002.00	991.056.00
790.483.12	990.075.00	991.061.00	791.011.00	541.002.00	991.056.00

Weatherseal Bits

HWM Z2 RH



Make your house more energy efficient by insulating old doors and windows. The CMT Weatherseal bit is the perfect bit to re-groove door and window frames to accommodate wind blocking inserts. Made of solid tungsten carbide for strength and endurance, these bits reach up to 12mm in depth without the risk of breakage.

Special double-sided design lets you save money by offering two tips in one bit; with the same features as the one-sided weatherseal bit. Only available with a 3mm (1/8") cutting diameter.

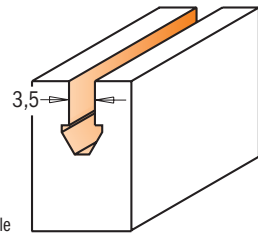
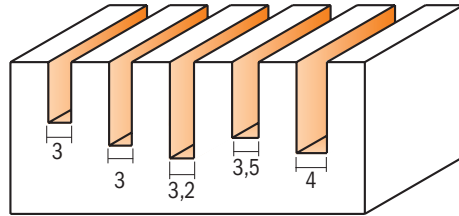

Drawing is 1:1 scale



7/813.001

D mm	I mm	L mm		ORDER NO. S=Ø6mm	ORDER NO. S=Ø6,35mm
3	8	76	10	711.031.11	
3	11	60	10	712.030.11	
3,2	12,7	50,8	10		812.032.11
3,5	12	60	10	191.635.11	
4	12	60	10	712.040.11	
3,5	8	76	10	713.001.11	
3,5	8	63,5	10		813.001.11

Combination Trimmer Bits

HW Z2 α RH

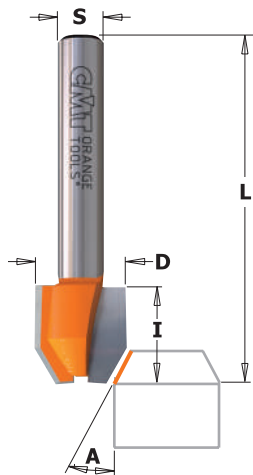

7/8/921

Work to your highest standards with the CMT combination trimmer bits. Now you can cut, trim and bevel all laminates without having to change the bit. Achieve great results when making straight or angled cuts on both soft and hardwood. Three popular sizes, each with carbide-tipped cutting edges for efficient bevel and straight trimming.

NOTICE: to be used with an edge, separate guide or fence.

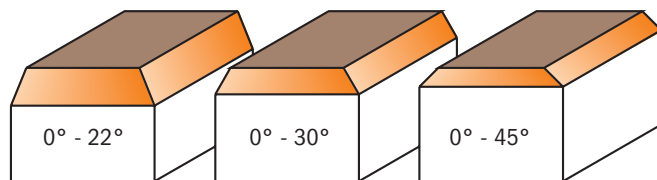

Drawing is 1:1 scale

A	D mm	I mm	L mm		ORDER NO. S=Ø6mm	ORDER NO. S=Ø6,35mm	ORDER NO. S=Ø8mm
0° - 22°	12	12,7	44,5	10	721.022.11	821.022.11	
0° - 30°	12	12,7	44,5	10	721.030.11	821.030.11	921.030.11
0° - 45°	12	12,7	44,5	10	721.045.11	821.045.11	

Combination Trimmer Bits

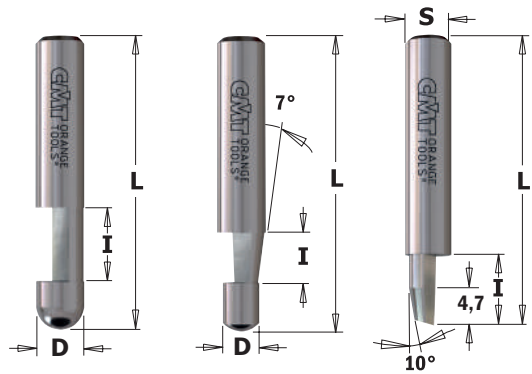

742.095
842.095

743.060
843.063

843.064

7/842 - 7/843



Work to your highest standards with CMT combination trimmer bits. Now you can cut, trim and bevel all laminates without having to change the bit. Achieve great results when making straight or angled cuts on both soft and hardwood. Three popular sizes, each with carbide-tipped edges, guarantee efficient bevels and straight trimming (7° or combined 0°-10°).

NOTICE: to be used with an edge, separate guide or fence.

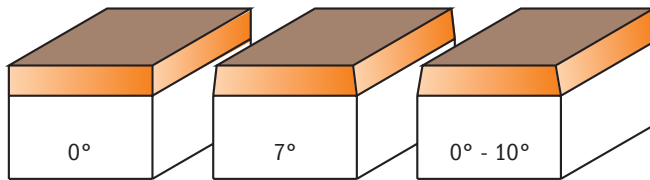

Drawing is 1:1 scale

A	D mm	I mm	L mm		ORDER NO. S=Ø6mm	ORDER NO. S=Ø6,35mm
0°	6	9,5	38	10	742.095.11	
0°	6,35	9,5	38	10		842.095.11
7°	4,5 - 6	6	38	10	743.060.11	
7°	4,76 - 6,35	6,35	38	10		843.063.11
0° - 10°	6,35	9,5	38	10		843.064.11
50 pc. masterpack						
0°	6,35	9,5	38			842.095.11-X50
7°	4,76 - 6,35	6,35	38			843.063.11-X50



50 pc. masterpack

Combination Trimmer Bits

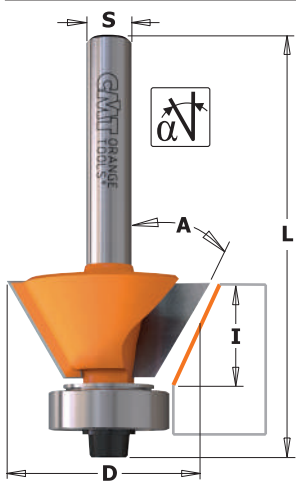

7/907 - 7/8/909 - 7/910

CMT's combination flush and bevel trim bits are perfect for executing a variety of superb precision finishing on laminates with ease without even changing the bit. Simply lower the bit cutting depth for precise right angle cuts or raise to 25° to create rounded edges. Suitable for both soft and hardwood. They feature two flutes for executing smoother cuts and for rounding off table legs and other soft areas on furniture susceptible to damage.

SHOP TIPS: after resharpening, replace bearing 791.002.11 (Ø9,5mm) with undersized bearing **791.062.00** (Ø9,3mm)



NON BLOCKING

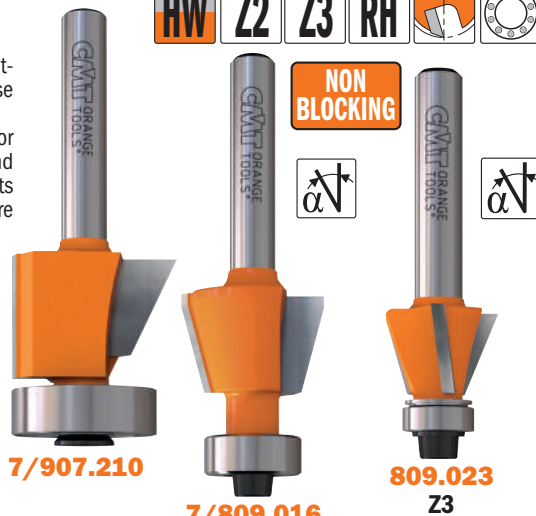

809.022
809.025
7/909.260
7/910.260

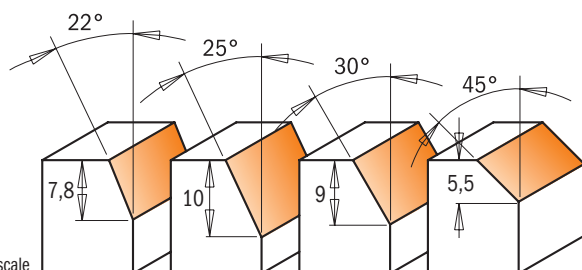

Drawing is 1:1 scale

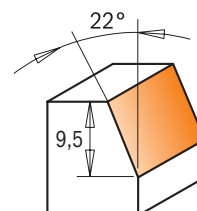
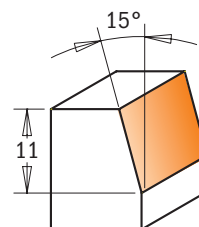
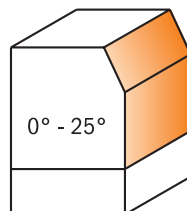

A	D mm	I mm	L mm	Z		ORDER NO. S=Ø6mm	ORDER NO. S=Ø6,35mm	ORDER NO. S=Ø8mm
0° - 25°	19 - 24,5	16 (10+6)	56,5	2	10	707.210.11		907.210.11
15°	18,6	11	57	2	10	709.016.11	809.016.11	
22°	12,7	7,8	47,6	2	10		809.022.11	
22°	17,5	9,5	51	3	10		809.023.11	
25°	19,05	10	52,4	2	10		809.025.11	
30°	27	9	55	2	10	709.260.11		909.260.11
45°	27	5,5	51,5	2	10	710.260.11		910.260.11

Spare parts

791.007.00	791.004.00	990.004.00	991.062.00
990.422.00	791.044.00	990.058.00	991.057.00
	791.035.00	990.062.00	991.060.00
990.422.00	791.002.00	990.058.00	991.057.00
990.422.00	791.002.00	990.058.00	991.057.00
990.423.00	791.018.00	990.058.00	991.057.00
990.423.00	791.018.00	990.058.00	991.057.00

Flush Trim Bits

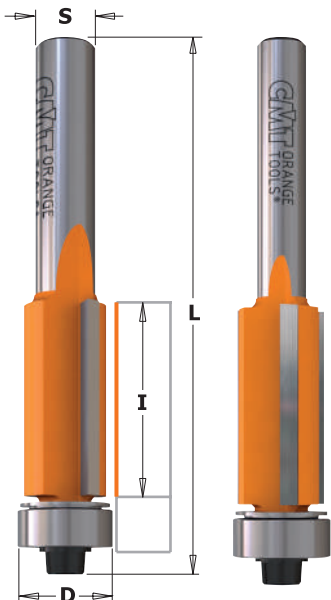

7/8/906

These truly indispensable bits were designed in a wide range of sizes for your woodworking needs as well as your most difficult projects. For precision work on laminates or quick template work with excellent finishing.

SHOP TIPS: these bits are excellent for making clean through-mortises. Use a straight bit Ø13mm (711.130.11) to produce a 5mm groove in the area you want to produce the through-mortise. With a drill bit Ø13mm (517.130.31) bore a hole through the wood at one end of the groove. Turn the workpiece over to finish the mortise. Use a flush trim bit Ø12mm with a cutting length slightly longer than the fillet, following the groove made on the opposite side of the workpiece with the ball bearing guide.

SAFETY TIPS: dust and chips from laminate materials are hazardous to your health and safety. Always wear a dust mask and eye protection when routing.

8/906.227.11
○ Z3

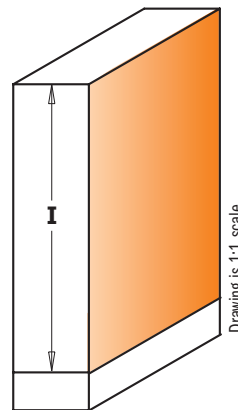

Masterpack

* **WARNING!** Long cutting edges! Carefully make several shallow passes to prevent damaging the tool. The CMT warranty does not cover improper use of the tool.

I mm	D mm	L mm	α		ORDER NO. S=Ø6mm	ORDER NO. S=Ø6,35mm	ORDER NO. S=Ø8mm	ORDER NO. S=Ø12mm	ORDER NO. S=Ø12,7mm
•25,4	6,35	63,5	0°	10	706.064.11	806.064.11			
12,7	9,5	55,5	0°	10	706.096.11	806.096.11	906.096.11		
12,7	12,7	57,8	-5°	10	706.128.11	806.128.11	906.128.11		
12,7	12,7	70,6	-5°	10				906.628.11	806.628.11
16	19	57,1	-5°	10	706.190.11		906.190.11		
25,4	9,5	68,2	0°	10	706.095.11	806.095.11	906.095.11		
25,4	12,7	70,7	-3°	10	706.127.11	806.127.11	906.127.11		
25,4	12,7	71	0°	10		806.227.11	906.227.11		
25,4	12,7	86,6	-3°	10				906.627.11	806.627.11
25,4	19	74,5	-5°	10	706.191.11	806.191.11	906.191.11		
25,4	19	87	-5°	10				906.691.11	806.691.11
38,1	12,7	94	0°	10				906.629.11	806.629.11
38,1	19	93,5	-3°	10				906.692.11	806.692.11
40	12,7	84	0°	10			906.129.11		
50,8	12,7	104	0°	10				906.630.11	806.630.11
50,8	19	110	-3°	10				906.690.11	806.690.11
*70	19	119	-3°	10				906.693.11	
10 pc. masterpack									
25,4	9,5	68,2	0°			806.095.11-X10			
25,4	12,7	70,7	-3°			806.127.11-X10		806.627.11-X10	
38,1	12,7	94	0°					806.629.11-X10	

Spare parts

	791.035.00	541.009.00	990.113.00
990.422.00	791.002.00		990.058.00
990.423.00	791.003.00		990.058.00
990.423.00	791.003.00		990.058.00
	791.007.00		990.004.00
990.422.00	791.002.00		990.058.00
990.423.00	791.003.00		990.058.00
990.423.00	791.003.00		990.058.00
990.423.00	791.003.00		990.058.00
990.425.00	791.004.00	541.550.00	990.058.00
990.425.00	791.004.00	541.550.00	990.058.00
990.423.00	791.003.00		990.058.00
990.425.00	791.004.00	541.550.00	990.058.00
990.423.00	791.003.00		990.058.00
990.423.00	791.003.00		990.058.00
990.425.00	791.004.00	541.550.00	990.058.00
990.425.00	791.004.00	541.550.00	990.058.00

• HWM

Spare parts: **991.055.00** 0,9mm hex key for screw (990.060.00)
991.057.00 3/32" hex key for screw (990.058.00)
991.062.00 2,5mm hex key for screw (990.004.00)

SHOP TIPS: after resharpening, replace bearing as follow:
 791.002.00 (Ø9,5mm) with undersized bearing **791.062.00** (Ø9,3mm)
 791.003.00 (Ø12,7mm) with undersized bearing **791.063.00** (Ø12,5mm)

Flush Trim Bit Set



806

Indispensable in any shop, the new 3 piece flush trim bit set gives you the option to trim laminates or do template work conveniently using just one instrument.

Set contains:

- 806.095.11** (Ø9,5x25,4mm)
- 806.096.11** (Ø9,5x12,7mm)
- 806.191.11** (Ø19x25,4mm)

DESCRIPTION		ORDER NO. S=Ø6,35mm
Flush Trim Bit Set	5	806.001.11



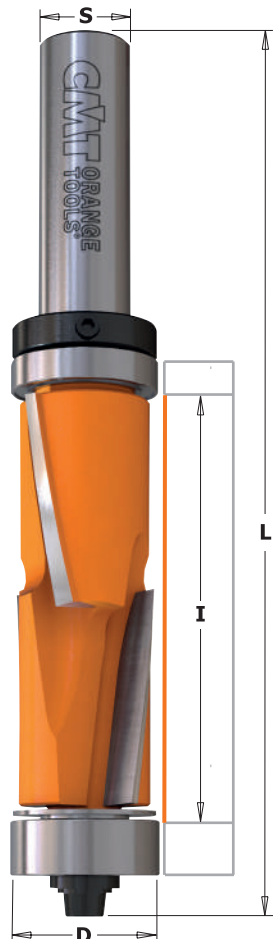

8/906B XTREME

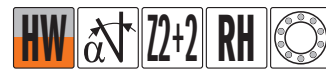

These new XTreme flush trim bits guarantee the best possible finish along with extra-long life thanks to one-of-a-kind spiral technology. 4 cutting edges in high quality carbide are crafted using special brazing techniques as well as unique positive and negative design thus eliminating splintering on the upper and lower sides of the material you're working with. Ideal for projects involving precious wood, melamine and delicate engineered veneers.

NOTA: use of variable speed routing machines is required.
 19mm bits Max RPM 18.000
 35mm bits Max RPM 16.000

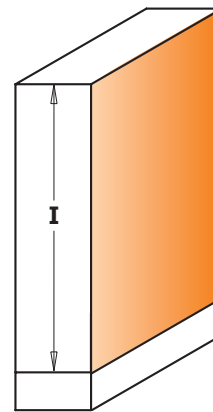
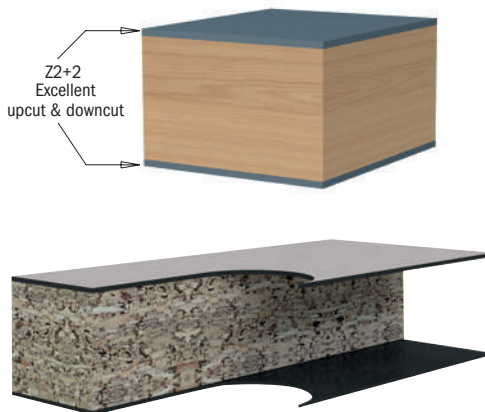

Drawing is 1:1 scale

I mm	D mm	L mm		ORDER NO. S=Ø6mm	ORDER NO. S=Ø6,35mm	ORDER NO. S=Ø8mm
25,4	12,7	80	10	706.127.41B		
25,4	12,7	80	10		806.127.41B	
25,4	19	86	10		806.191.41B	
25,4	19	86	10			906.191.41B

Spare parts

990.423.00	791.003.00		990.058.00	791.010.00	541.003.00
990.423.00	791.003.00		990.058.00	791.010.00	541.001.00
990.425.00	791.004.00	541.550.00	990.058.00	791.004.00	541.001.00
990.425.00	791.004.00	541.550.00	990.058.00	791.034.00	541.004.00

I mm	D mm	L mm		ORDER NO. S=Ø12mm	ORDER NO. S=Ø12,7mm
50,8	19,05	113	10	906.690.41B	806.690.41B
50,8	34,9	123	10	906.880.41B	806.880.41B

Spare parts

990.425.00	791.004.00	541.550.00	990.058.00	791.011.00	541.002.00
990.426.00	791.029.00	541.552.00	990.058.00	791.029.00	541.002.00

Spare parts: **991.056.00** 1,5mm hex key for screw (M3)
991.057.00 3/32" hex key for screw (990.058.00)

DP - Flush Trim Bits for Laminates



7/8/906 XTREME



These new super duty DP (polycrystalline diamond) bits represent the ultimate in the extensive line of CMT flush trim bits. Investing in CMT DP flush trim bits means saving time and money, as they last 40 times longer than conventional carbide-tipped flush trim bits.

SHOP TIPS: after resharpening, replace bearing 791.003.11 (Ø12,7mm) with undersized bearing **791.063.00** (Ø12,5mm)

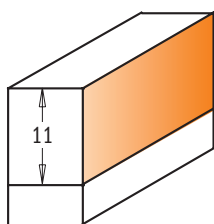

Drawing is 1:1 scale



I mm	D mm	L mm		ORDER NO. S=Ø6mm	ORDER NO. S=Ø6,35mm	ORDER NO. S=Ø8mm
11	12,7	58,1	10	706.128.61	806.128.61	906.128.61

Spare parts

990.423.00	791.003.00	990.058.00	991.057.00

Double-Bearing Spiral Flush Trim Bits

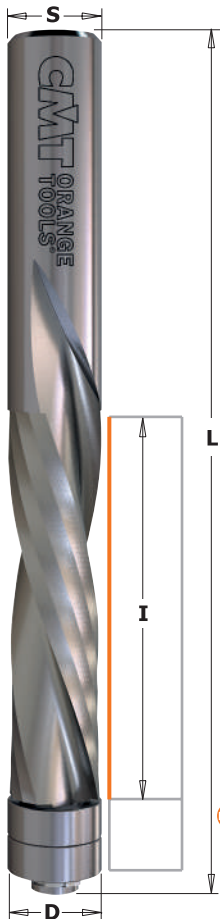

190B - 191B - 192B

CMT solid carbide spiral flush trim bits are composed of a special super-micrograin formulation increasing hardness with a higher transverse rupture point. Combined with a spiral cutting angle, CMT solid carbide spiral flush trim bits equipped with a double bearing, allow cabinet makers to shear wood and wood products cleanly, providing more efficient chip ejection than standard flush trim bits. In production settings, this means these bits will run cooler, stay sharper, last longer and increase shop productivity.

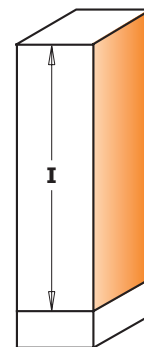
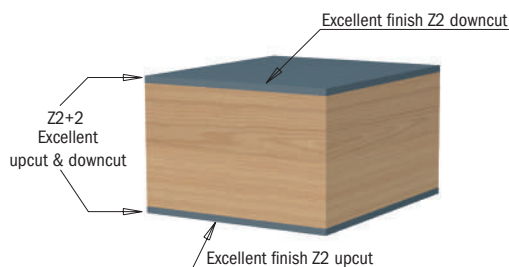
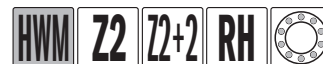

Drawing is 1:1 scale

I mm	D mm	L mm		ORDER NO. S=Ø6mm	ORDER NO. S=Ø6,35mm	ORDER NO. S=Ø12mm	ORDER NO. S=Ø12,7mm
Z2+2 Upcut & Downcut							
47	12,7	114	10			190.127.11B	190.508.11B
Z2 Upcut							
25,4	6,35	76,2	10	191.064.11B	191.008.11B		
31,7	12,7	89	10				191.505.11B
50,8	12,7	114	10			191.127.11B	191.507.11B
Z2 Downcut							
25,4	6,35	76,2	10		192.008.11B		
31,7	12,7	89	10				192.505.11B
50,8	12,7	114	10			192.127.11B	192.507.11B

Spare parts

791.010.00		541.301.00
791.035.00	541.009.00	
791.010.00		541.301.00
791.010.00		541.301.00
791.035.00	541.009.00	
791.010.00		541.301.00
791.010.00		541.301.00

3-in-1 Flush Trim Bits for MDF/Laminate

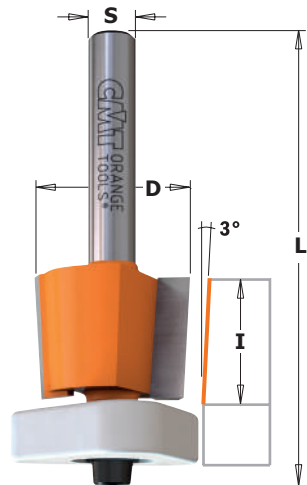

7/8/907

3 in 1 new flush trim bits with DELRIN® Triangular bearings are your best partner for laminate trimming. In fact, it solves three of the most common problems that occur when flush trimming:

- 1) The anti-stick properties of the DELRIN® bearing greatly reduces the likelihood of freezing of the bearing from glue.
- 2) The extended guide surface of the new DELRIN® bearing will perfectly match the work surface without scratching like a steel bearing would. The DELRIN® bearing also guarantees maximum stability.
- 3) The shear angle cutting edge reduces the need for filing. 3-in-1 bits are ideal on plastic laminates as well as aluminium laminates!

3-in-1 bits are ideal on plastic laminates as well as aluminium laminates!

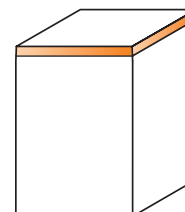

Drawing is 1:1 scale

NON BLOCKING



Patent No. D628,218

- Extended guide surface
- Non-freezing
- Non-scratch surface



Perfect trimming with conical edges!

Thanks to the innovative conical edges of this bit, you will always get perfect cuts even after re-sharpening. In fact, the most common problem you have with standard flush trim bits is the undersized diameter after re-sharpening which leaves a mark on the material; with the new CMT construction you could re-sharpen up to six times without any problem. Just remember to adjust your bit up or down as per the illustration.

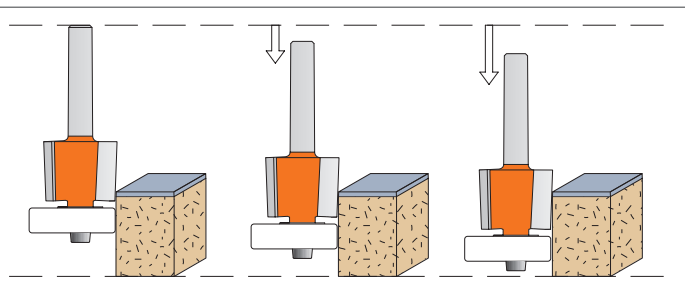

I mm	D mm	L mm		ORDER NO. S=Ø6mm	ORDER NO. S=Ø6,35mm	ORDER NO. S=Ø8mm	ORDER NO. S=Ø12,7mm
12,7	12,7	54,2	10	707.128.11	807.128.11	907.128.11	
15,87	19	59,3	10	707.190.11	807.190.11	907.190.11	
15,87	19	65,7	10				807.690.11

Spare parts

990.422.00	791.042.00	990.058.00	991.057.00
990.423.00	791.043.00	990.058.00	991.057.00
990.423.00	791.043.00	990.058.00	991.057.00



657.9

Specially designed to perform difficult trimming operations, these bits are both indispensable and economical. Flush trim bits with two replaceable knives fixed by special TORX® screws. The 2-sided blades can create extra new edges. Guided flush trim bits type **657.1** are equipped with ball bearing guides.



SAFETY TIPS:



The **TW-006** Torque Screwdriver is recommended for the proper fastening of screws (see page 406).

CORRECT KNIFE POSITIONING

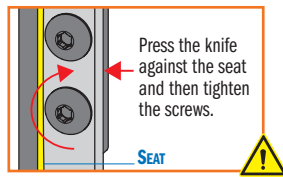

Press the knife against the seat and then tighten the screws.

SEAT

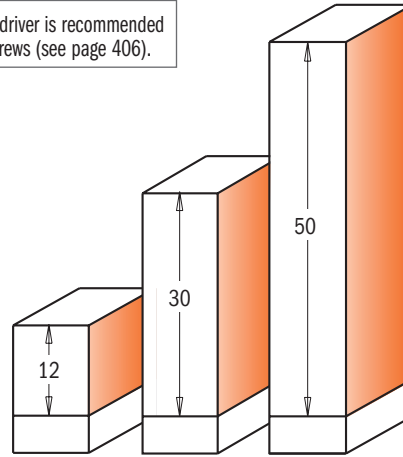

Drawing is 1:1 scale

657.1



I mm	D mm	L mm		ORDER NO. S=Ø6mm	ORDER NO. S=Ø6,35mm	ORDER NO. S=Ø8mm	ORDER NO. S=Ø12mm	ORDER NO. S=Ø12,7mm
12	19	57	10	657.194.11	657.192.11	657.190.11		
30	16	75	10			657.161.11		
30	19	76	10	657.195.11				
30	19	77	10			657.191.11		
30	19	87	10					657.692.11
50	19	112	10				657.991.11	657.992.11

Spare parts

790.120.00	990.075.00	991.061.00	791.007.00
790.295.09	990.115.00	991.061.00	791.006.00
790.300.00	990.075.00	991.061.00	791.007.00
790.300.00	990.075.00	991.061.00	791.007.00
790.300.00	990.075.00	991.061.00	791.007.00
790.500.00	990.075.00	991.061.00	791.007.00

Spare parts: **990.400.00** Ø3.2/Ø7mm shield for M3 screw
990.410.00 Ø4.2/Ø9mm shield for M4 screws
990.051.00 M3x6mm TCEI screws

990.052.00 M4x6mm TCEI screws
991.067.00 3mm hex key
541.514.00 Ø6,4mm shield

FILE-FREE Flush Trim Bits for Laminate

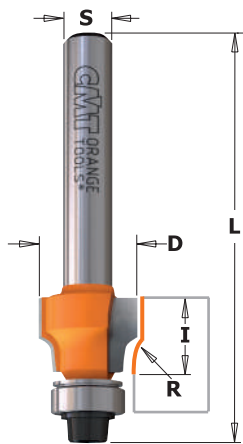

8/907



This bit is perfect for ensuring smooth flawless results on your laminate surfaces after flush trimming. Sharp edges are easily trimmed away, leaving your surfaces nice and smooth to the touch. No further filing is needed!

SHOP TIPS: after resharpening, replace bearing 791.002.00 (Ø9,5mm) with undersized bearing **791.062.00** (Ø9,3mm)

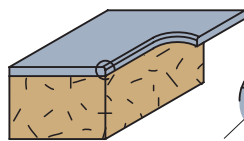

Drawing is 1:1 scale

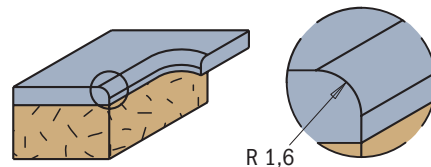

D mm	I mm	R mm	L mm		ORDER NO. S=Ø6,35mm	ORDER NO. S=Ø8mm
12,7	9,5	0,4	52	10	807.004.11	907.004.11
12,7	9,5	1,6	52	10	807.015.11	907.015.11

Spare parts

990.422.00	791.002.00	990.058.00	991.057.00
990.422.00	791.002.00	990.058.00	991.057.00

Pattern/Flush Trim Bits with Insert Knives



657B

These bits complete the wide range of CMT Flush Trim bits equipped with a bearing. A larger 19mm diameter and double bearing distinguishes this bit from the others given its increased stability throughout flush and trimming operations. This means completing difficult projects safely, especially when you require a significant amount of swarf removal and an optimal precision finish.



CORRECT KNIFE POSITIONING

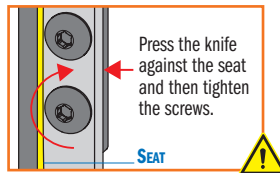

SAFETY TIPS:



The **TW-006** Torque Screwdriver is recommended for the proper fastening of screws (see page 406).

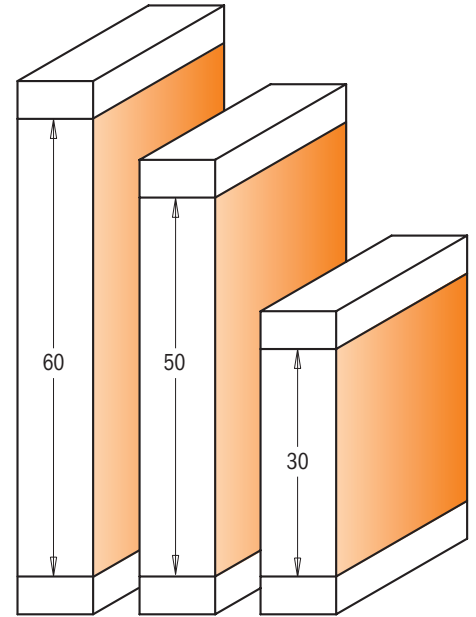

Drawing is 1:1 scale

I mm	D mm	L mm	Box	ORDER NO. S=Ø8mm	ORDER NO. S=Ø12mm	ORDER NO. S=Ø12,7mm
30	19	90	10	657.191.11B		657.692.11B
30	19	90	10			657.692.11B
50	19	110	10		657.993.11B	657.994.11B
60	19	120	10		657.995.11B	657.996.11B

Spare parts

Shield	Screw	Insert	Insert	Insert	Insert
790.300.00	990.075.00	791.007.00	990.052.00	791.034.00	541.004.00
790.300.00	990.075.00	791.007.00	990.052.00	791.011.00	541.002.00
790.500.00	990.075.00	791.007.00	990.052.00	791.011.00	541.002.00
790.600.00	990.075.00	791.007.00	990.052.00	791.011.00	541.002.00

Spare parts: **990.410.00** Ø4,2/Ø9mm shield for M4 screws
991.067.00 3mm hex key

991.061.00 T15 TORX® key
991.056.00 1,5mm hex key

Flush Trim Router Bits with Double Bearing

806/906B



The innovative two-flute router bits are equipped with a double bearing and feature a down shear design allowing cleaner, smoother cuts on a variety of materials.

Now its no longer necessary to flip or move your tool during routing operations. This tool is particularly effective when routing curved elements along or against the grain.

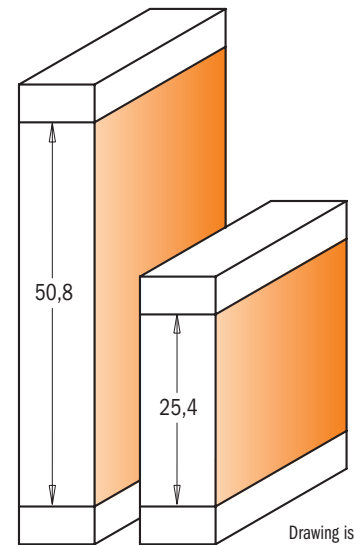

Drawing is 1:1 scale



I mm	D mm	L mm	α	Box	ORDER NO. S=Ø12mm	ORDER NO. S=Ø12,7mm
25,4	19	86,5	-5°	10	906.691.11B	
25,4	19	86,5	-5°	10		806.691.11B
50,8	19	109,5	-3°	10	906.690.11B	
50,8	19	109,5	-3°	10		806.690.11B

Spare parts

Shield	Insert	Insert	Screw	Insert	Insert
990.425.00	791.004.00	541.550.00	990.058.00	791.011.00	541.005.00
990.425.00	791.004.00	541.550.00	990.058.00	791.011.00	541.002.00
990.425.00	791.004.00	541.550.00	990.058.00	791.011.00	541.005.00
990.425.00	791.004.00	541.550.00	990.058.00	791.011.00	541.002.00

Spare parts: **991.057.00** 3/32" hex key

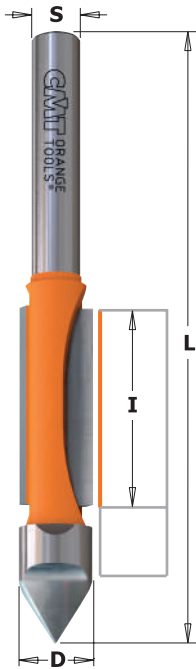

7/8/916

How much time do you end up spending making openings in paneling, drywall, siding, doors or windows? With the CMT panel pilot bit, the job just got quicker. The point of this bit as well as the **716.061**, plunge smoothly and easily and the carbide edges cut clean and fast. All of this adds up to accurate cuts in less time and with less effort - great for trimming veneer as well as a variety of laminates.

SAFETY TIPS: always use extra caution when working near electrical outlets and boxes - always shut off the power. Make sure the bit does not go so deep as to touch or cut the wires.

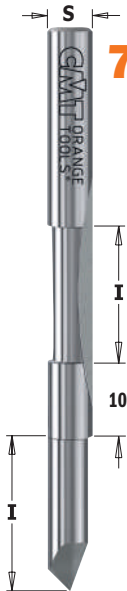

716.061
• HWM

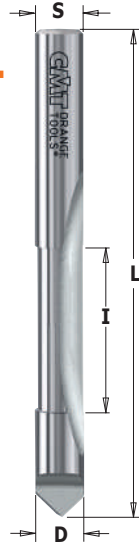

716.060
816.064
• HWM



Masterpack

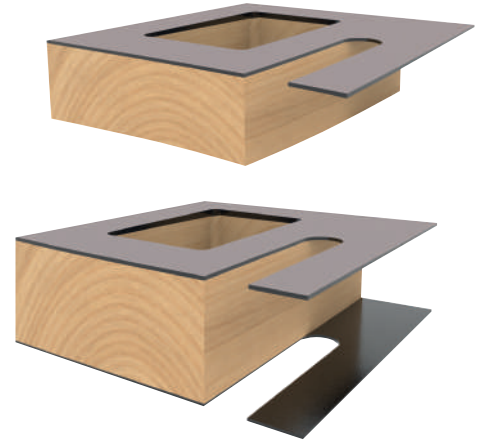

D mm	I mm	L mm	Z		ORDER NO. S=Ø6mm	ORDER NO. S=Ø6,35mm	ORDER NO. S=Ø8mm	ORDER NO. S=Ø12mm	ORDER NO. S=Ø12,7mm
•6	19	60	1	10	716.060.11				
•6	18+18	70	1+1	10	716.061.11				
•6,35	19	64	1	10		816.064.11			
8	19	64	1	10			916.080.11		
9,53	25,4	78	2	10		816.095.11			
12	31,7	102	2	10				916.627.11	
12,7	31,7	102	2	10					816.627.11
10 pc. masterpack									
new •6,35	19	64	1			816.064.11-X10			
12,7	31,7	102	2						816.627.11-X10

• HWM

Panel Pilot Bits with Guide

7/8/953



An absolutely indispensable bit for making cabinets. CMT Flush and V-Groove bits allow you to make cabinet front frames in 25mm stock that fit perfectly with the sides. The added V-cutter feature makes a decorative groove along the hinge joint to hide the seam.

SHOP TIPS: For best results, leave less than 3mm overhang on cabinet front frames for easier routing.

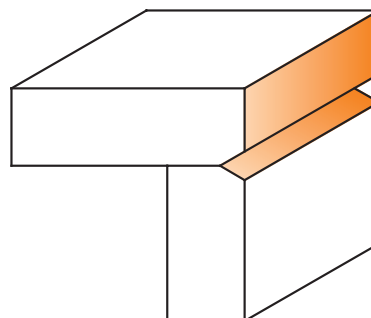
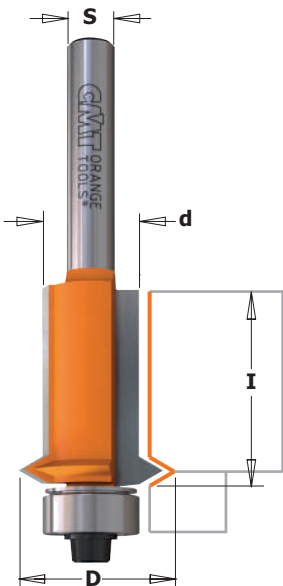

Drawing is 1:1 scale

d mm	D mm	I mm		ORDER NO. S=Ø6mm	ORDER NO. S=Ø6,35mm	ORDER NO. S=Ø8mm	ORDER NO. S=Ø12mm	ORDER NO. S=Ø12,7mm	Spare parts							
12,7	19	25,4	10	753.001.11	853.001.11	953.001.11	953.501.11	853.501.11					990.423.00	791.003.00	990.058.00	991.057.00

The CMT Grand Rabbet Set



8/935.503

"The Grand Rabbet" by CMT is an investment that shows your commitment to quality. This CMT product will deliver years of reliable service under normal use. For safe and trouble-free results please observe the following instructions and safety precautions. The complete kit (item code **835-935.503.11**), will enable you to produce 17 different rabbet sizes including rabbets for under-sized plywood applications. For rabbet sizes over 12,7mm (1/2"), make the cuts in several shallow passes until the desired depth is achieved. Available in 12mm and 12,7mm shanks.

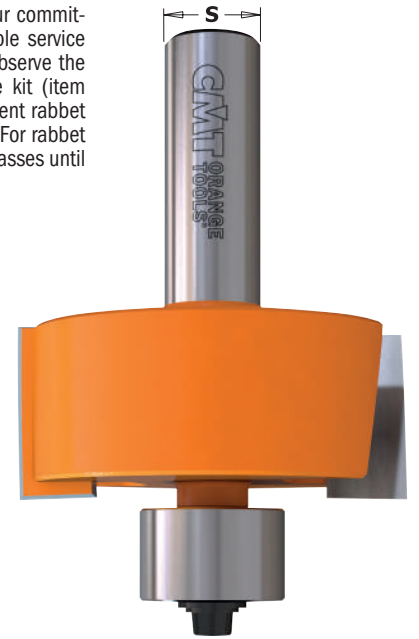

8/935.990

Collar order no.
799.517.00

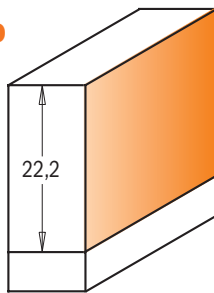

Order no. **791.705.00**

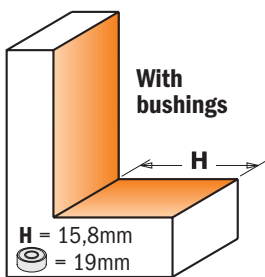
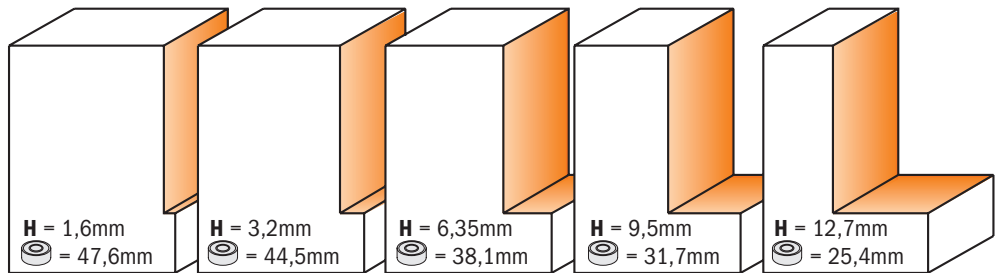

Order no. **791.706.00**

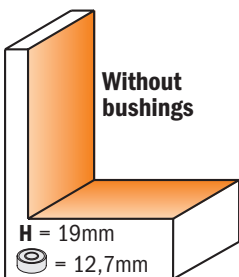
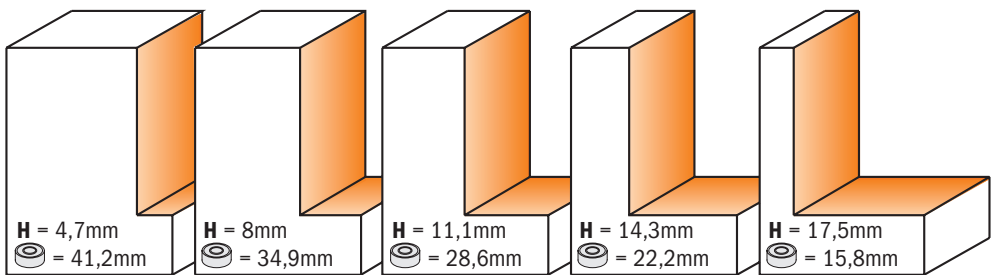

Order no. **791.707.00**

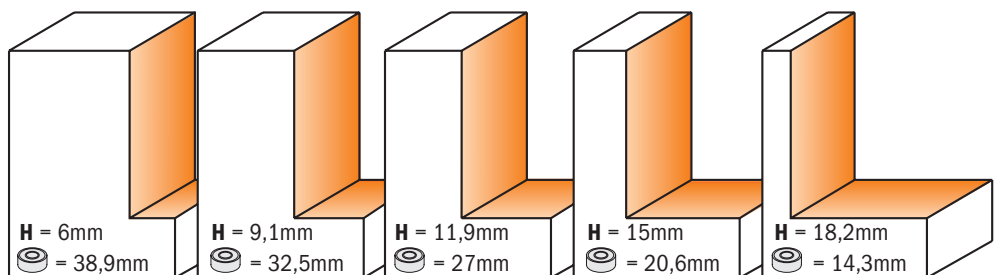

Drawing is 1:1 scale

DESCRIPTION	ORDER NO. S=Ø12mm	ORDER NO. S=Ø12,7mm
The CMT Grand Rabbet Set (Ø50,8x22,2mm)	935.503.11	835.503.11
Set contains: The Grand Rabbet (bit only) with bushing Ø19mm	935.990.11	835.990.11
5 pcs. Bushing kits for bearing (H=1,6 - 3,2 - 6,35 - 9,5 - 12,7mm rabbets)		791.705.00
5 pcs. Bushing kits for bearing (H=4,7 - 8 - 11,1 - 14,3 - 17,5mm rabbets)		791.706.00
5 pcs. Bushing kits for bearing (H=6 - 9,1 - 11,9 - 15 - 18,2mm rabbets)		791.707.00
Bushing Ø50,8mm		799.517.00
Kit with screw, shields and keys		990.452.00



660.9

"The Grand Rabbet" by CMT is an investment that shows your commitment to quality. This CMT product will enable you to produce 17 different rabbet sizes including rabbets for under-sized plywood applications. For rabbet sizes over 12,7mm (1/2"), make the cuts in several shallow passes until the desired depth is achieved. Available in 12mm and 12,7mm shanks.

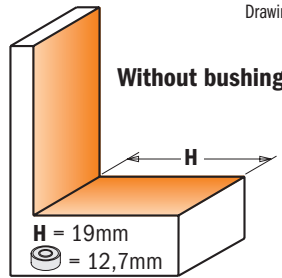
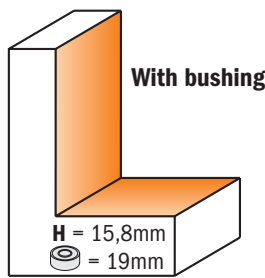

Drawing is 1:1 scale

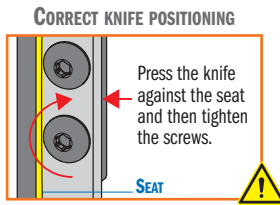
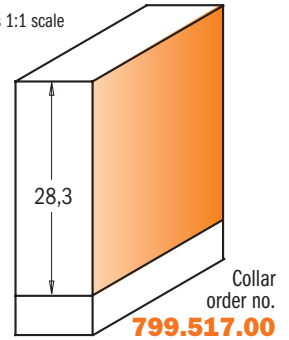

SAFETY TIPS:

The **TW-006** Torque Screwdriver is recommended for the proper fastening of screws (see page 406).

H mm	D mm	I mm	L mm		ORDER NO. S=Ø12mm	ORDER NO. S=Ø12,7mm
16	50,8	28,3	86	10	660.990.11	660.991.11

Spare parts

790.283.12	990.075.00	991.061.00	791.010.00

Spare parts: **541.514.00** Ø6,4mm stop collar

799.503.00 Ø19,05mm bushings

990.410.00 Ø4.2/Ø9mm shield for M4 screw

990.052.00 M4x6mm TCEI screw

991.067.00 3mm hex key

990.469.00 Kit screw, shield and key

Optional: **799.517.00** Bushing for flush trim Ø50,8mm

791.705.00 5 pcs. bushing set (H=1,6-3,2-6,35-9,5-12,7mm rabbets)

791.706.00 5 pcs. bushing set (H=4,7-8-11,1-14,3-17,5mm rabbets)

791.707.00 5 pcs. bushing set (H=6-9,1-11,9-15-18,2mm rabbets)

Rabbeting Bits

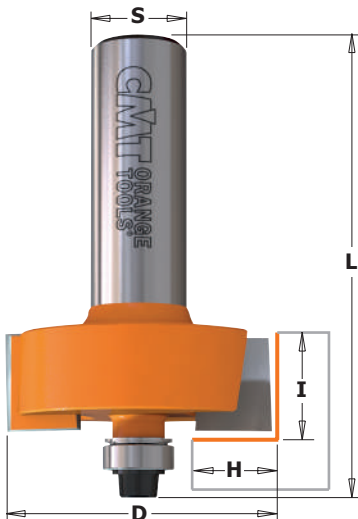

7/8/935



CMT carbide-faced rabbeting bits are fast and accurate - you can quickly produce inset doors and drawer fronts, make strong rabbet joints, mill perfect tongue and groove joints or any number of other jobs usually time consuming and difficult. Other possibilities for these tungsten carbide bits are illustrated below and on the following pages.

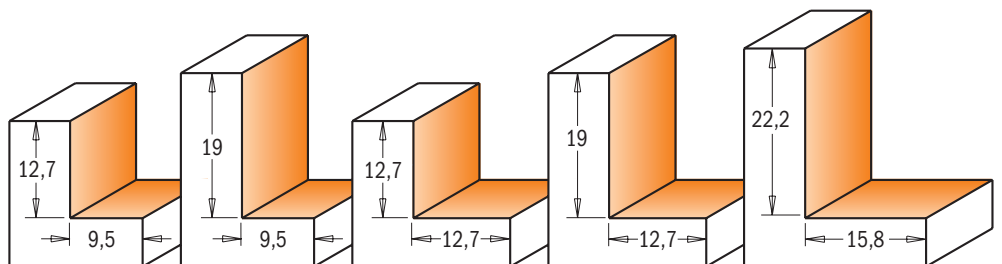

Drawing is 1:1 scale

H mm	D mm	I mm	L mm		ORDER NO. S=Ø6mm	ORDER NO. S=Ø6,35mm	ORDER NO. S=Ø8mm	ORDER NO. S=Ø12mm	ORDER NO. S=Ø12,7mm
9,5	31,7	12,7	58,4	10	735.317.11	835.317.11	935.317.11		
9,5	31,7	12,7	61,2	10			935.817.11	835.817.11	
9,5	31,7	19	64,8	10	735.318.11		935.318.11		
12,7	34,9	12,7	59,4	10	735.350.11	835.350.11	935.350.11	935.850.11	835.850.11
12,7	34,9	19	65,8	10				935.851.11	835.851.11
15,8	50,8	22,2	77,8	10				935.990.11	835.990.11

Spare parts

990.423.00	791.003.00	990.058.00
990.423.00	791.003.00	990.058.00
990.423.00	791.003.00	990.058.00
990.422.00	791.002.00	990.058.00
990.422.00	791.002.00	990.058.00
990.408.00	791.010.00	990.058.00

Spare parts: **541.514.00** 2mm spacer (8/935.990.11)

799.503.00 19,05mm bushings

991.057.00 3/32" hex key

Rabbeting Bits with Insert Knives

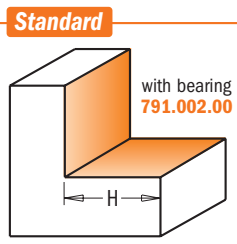
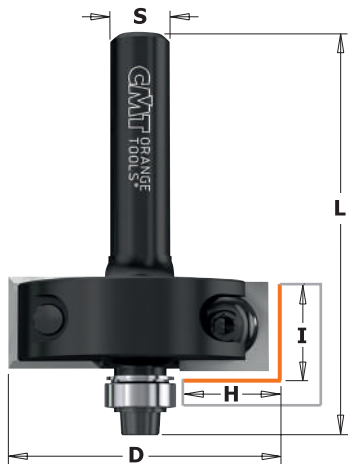

Drawing is 1:1 scale

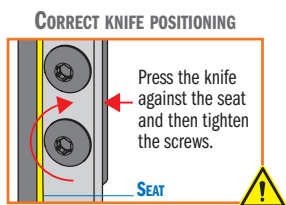

660



Rabbeting bits for creating cabinet doors, backsides and drawer fronts. Every bit is equipped with a standard bearing (791.002.00), but other bearings are also available in order to craft a variety of rabbeting widths. For use on chipboard, wood or MDF.

SAFETY TIPS:



The **TW-006** Torque Screwdriver is recommended for the proper fastening of screws (see page 406).

791.703.00 **Optional**



Drawing is 1:1 scale

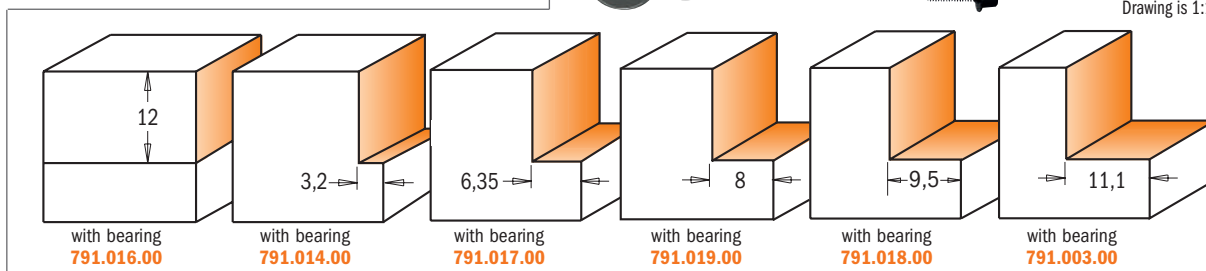

with bearing 791.016.00

with bearing 791.014.00

with bearing 791.017.00

with bearing 791.019.00

with bearing 791.018.00

with bearing 791.003.00

H mm	D mm	Z	I mm	L mm	Box	ORDER NO. S=Ø6,35mm	ORDER NO. S=Ø8mm	ORDER NO. S=Ø12mm	ORDER NO. S=Ø12,7mm
12,7	34,9	2	12	55	10	660.351.11	660.350.11		660.851.11
12,7	34,9	2	12	65	10				660.851.11
22,2	57	4	12	66	5			660.570.11	

Spare parts

Image	Image	Image
790.120.00	990.422.00	791.002.00
790.120.00	990.422.00	791.002.00
790.120.03	990.423.00	791.003.00

Spare parts: 990.075.00 M4x6mm TORX® screw

991.061.00 T15 TORX® key

990.058.00 1/8"x3/8"x1/2" TCEI screw

990.057.00 3/32" hex key

Rabbeting Sets

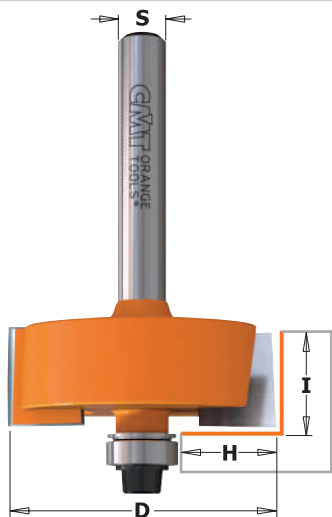

7/8/935.001



CMT rabbeting sets include one rabbeting bit, 6 interchangeable ball bearing guides, fastening screws, shields and an Allen Key. In order to change cutting depth, substitute the bearing.

791.703.00 **Standard**



BE SURE to keep the black bearing washer right side up to correspond with the bearing rotation when re-assembling the bearing. Improper re-assembly can cause the screw to come loose.

Drawing is 1:1 scale

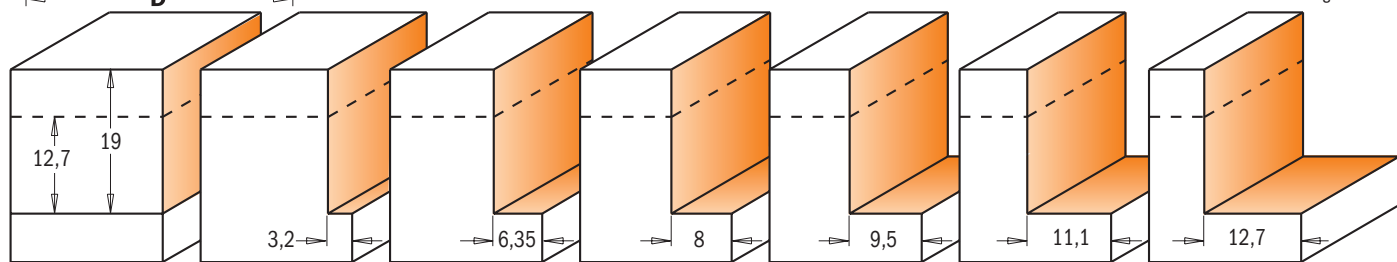

H mm	D mm	I mm	Box	ORDER NO. S=Ø6mm	ORDER NO. S=Ø6,35mm	ORDER NO. S=Ø8mm	ORDER NO. S=Ø12mm	ORDER NO. S=Ø12,7mm
0-12,7	34,9	12,7	5	735.001.11	835.001.11	935.001.11	935.501.11	835.501.11
0-12,7	34,9	19	5				935.502.11	835.502.11

Spare parts: 791.002.00 Ø4,76/Ø9,5mm bearing

990.058.00 1/8"x3/8"x1/2" TCEI screw

990.422.00 Ø4,76/Ø9,5mm shield

990.057.00 3/32" hex key

Keyhole Bits

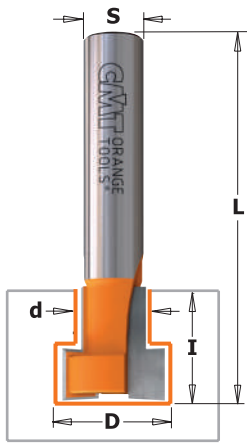

7/8/950.0_5

With the CMT keyhole bit you can make holes that keep your frames, plaques or any wall hanging perfectly straight and attached to the wall. The perfect way to securely mount wall hangings on screws and nails. Three new bits available to create slots for M5, M6, M8, M10, M12 hexagonal head bolt for removable joints.

SAFETY TIPS: Be sure the workpiece is securely fastened to the router table or work bench.

SHOP TIPS: Recommended for use with a plunge router.

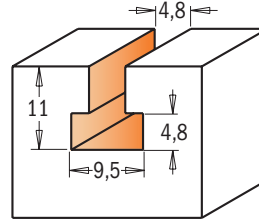

Drawing is 1:1 scale

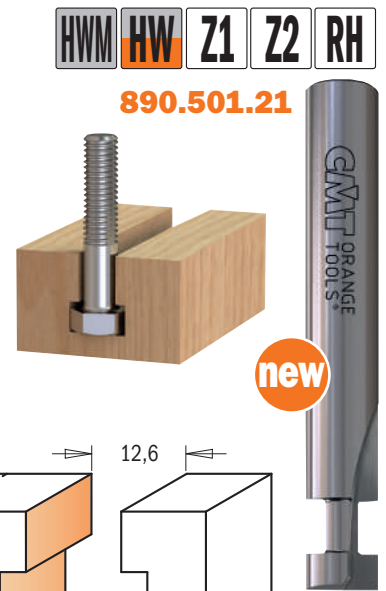

890.501.21

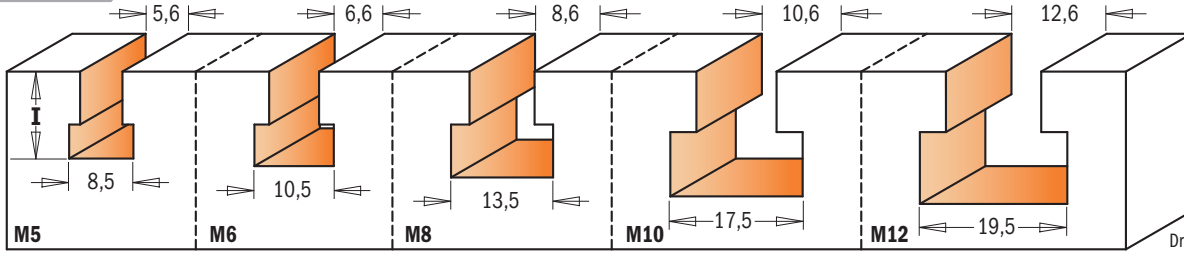

Drawing is 1:1 scale

D mm	d mm	I mm	L mm	Z		ORDER NO. S=Ø6mm	ORDER NO. S=Ø6,35mm	ORDER NO. S=Ø8mm	ORDER NO. S=Ø9,5mm	ORDER NO. S=Ø12mm	ORDER NO. S=Ø12,7mm
9,5	4,8	11	54	1		10	750.001.11	850.001.11	950.001.11	950.501.11	850.501.11
new 9,5	4,76	11	65	2		10			850.501.21		
8,5	5,6	11,5	48	1	M5	10		950.002.11			
10,5	6,6	12,5	48	1	M6	10		950.003.11			
13,5	8,6	14	48	2	M8	10		950.004.11			
new 17,5	10,6	16,5	48	2	M10	10		950.005.11			
new 19,5	12,6	17,5	48	2	M12	10		950.006.11			

• HWM

T-Slot Bits

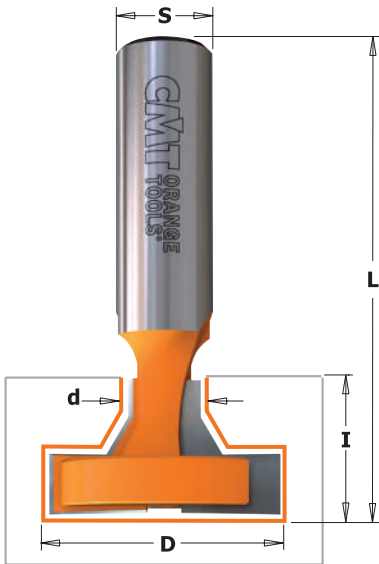

8/950.1_6

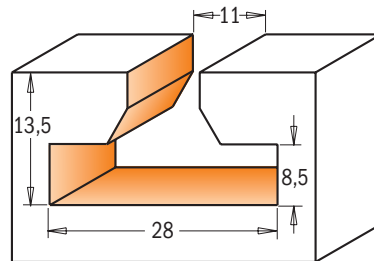

8/950.103 - 603

Drawing is 1:1 scale

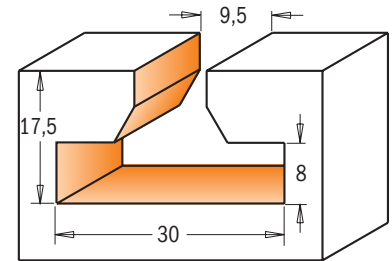

8/950.101 - 601

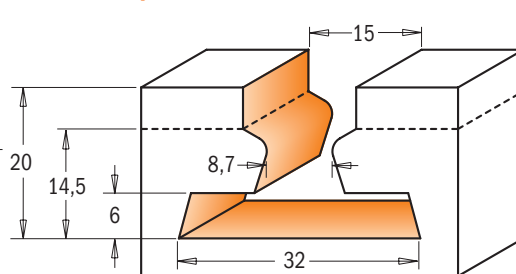

950.604

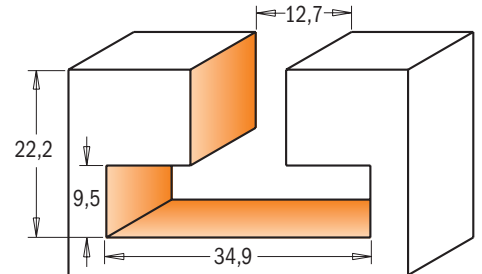

8/950.602

D mm	d mm	I mm	L mm	Z		ORDER NO. S=Ø8mm	ORDER NO. S=Ø12mm	ORDER NO. S=Ø12,7mm
new 28	11	13,5	47,6	2	10	950.103.11		
28	11	13,5	56,3	2	10		950.603.11	850.603.11
new 30	9,5	17,5	50,8	2	10	950.101.11		
30	9,5	17,5	60,3	2	10		950.601.11	850.601.11
32	8,7-15	20	66	1+1	10		950.604.11	
34,9	12,7	22,2	63,5	2	10		950.602.11	850.602.11

Screw Slot Bits

HW Z2 RH

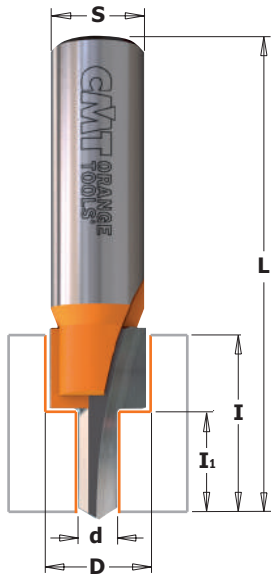

8/913

Any large panel or table top should be secured in a way that allows it to expand or contract without splitting. These screw-slot bits let you create screw slots so that panels can be held in place but are able to slide back and forth without splitting the wood or breaking the screw securing them.

Bits available in 8 and 12,7mm shank; art. **913.201.11** and art. **813.701.11** correspond to countersink screws and art. **913.101.11** and art. **813.601.11** correspond to flat-head screws.

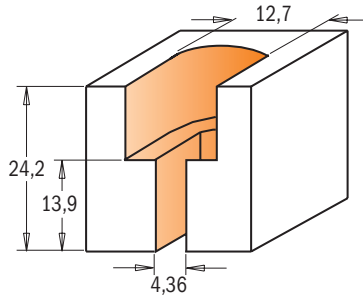

Drawing is 1:1 scale

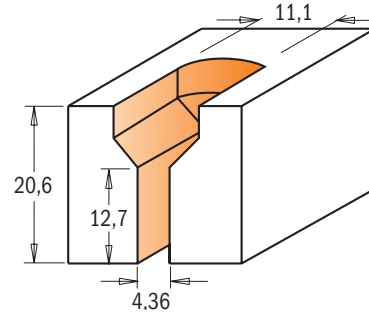

913.201.11
813.701.11

913.101.11
813.601.11



D mm	d mm	I ₁ mm	I mm	L mm		ORDER NO. S=Ø8mm	ORDER NO. S=Ø12,7mm
11,1	4,36	12,7	20,6	63,5	10	913.201.11	813.701.11
12,7	4,36	13,9	24,2	63,5	10	913.101.11	813.601.11

Flooring Router Bits

HW Z2 RH

822.023B - 822.024B

CMT now offers you these industrial quality carbide-tipped router bits for flooring and inlay applications. They easily and smoothly run through solid and timber wood while cutting edges and remain sharp even after several passes **822.024.11B** item number also features rounded edges to produce 3,2mm (1/8") radius inlays. These bits are equipped with a stop collar and a bearing.

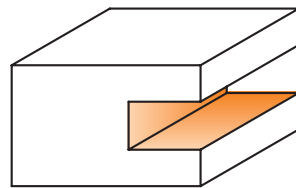
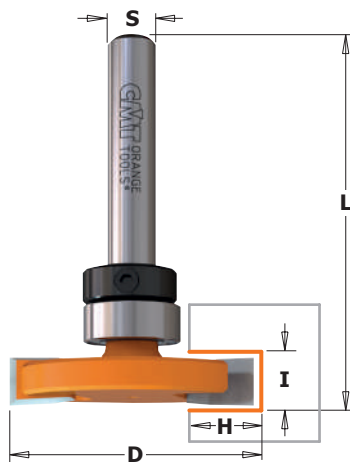

Drawing is 1:1 scale

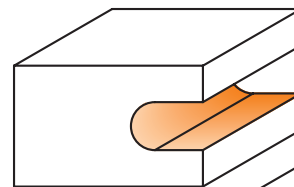

822.024.11B



822.023.11B

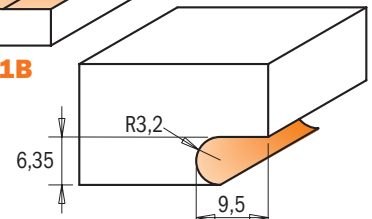
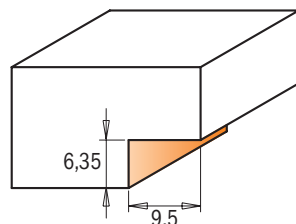

D mm	I mm	H mm	R mm	L mm		ORDER NO. S=Ø6,35mm
31,75	6,35	9,5		47,6	10	822.023.11B
31,75	6,35	9,5	3,2	47,6	10	822.024.11B

Spare parts

791.010.00	541.001.00	990.005.00	991.056.00
791.010.00	541.001.00	990.005.00	991.056.00

3-Wing Slot Cutter

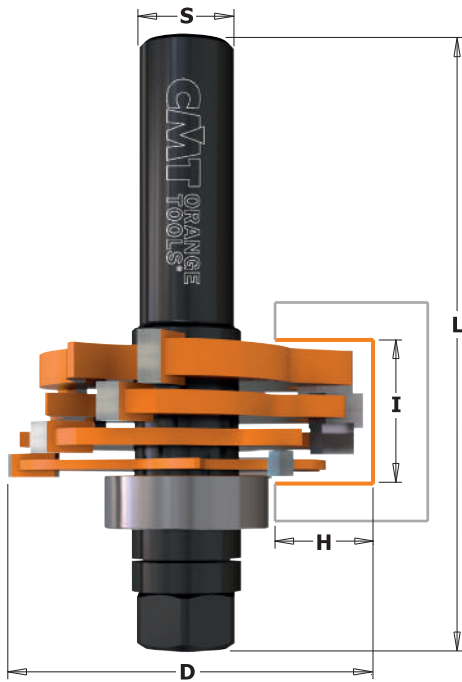

8/900.506

Create slots, grooves and rabbets in materials from 3,2mm to 18mm in depth by using the adjustable CMT 3-Wing slot cutter set. See chart below for details on spacing and correct cutter combinations. Ideal for biscuit joints and milling perfect tongue and groove joints. This set includes:

- 4 carbide tipped cutters 3,2mm, 4mm, 4,8mm, 6,4mm
- 1 arbor 12mm or 12,7mm
- 1 ball bearing (22mm) for 12,7mm cut
- 17 shims: (8x0,1mm - 4x0,5mm - 3x1mm and 2x4mm)

SAFETY TIPS: never use the slot cutter set without shims between the cutters. The distance between the cutters can vary from 1mm to 1,7mm. A shim must also be positioned between the ball bearing and the cutters.

SHOP TIPS: the bearings kit **791.711.00** makes 6,35mm and 9,5mm cutting depths.

NOTE: the carbide edges of the cutters must never touch; arrange the shims as illustrated below. Use only thicknesses provided in the set. Be sure all cutters are assembled in the correct rotational direction. Looking downwards on the arbor, the cutters will turn clockwise.

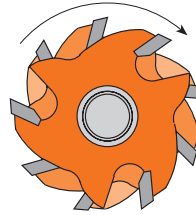

Cutter combinations	Cutter height	
	mm	mm
A	3,2	
B	4	
C	4,8	
D	6,4	
A + B	6,4	a 7,1
A + C	7,2	a 7,9
A + D	8,8	a 9,5
B + C	8	a 8,7
B + D	9,6	a 10,3
C + D	10,4	a 11,1
A + B + C	10,4	a 11,8
A + B + D	11,9	a 13,3
A + C + D	12,7	a 14,1
B + C + D	13,5	a 14,9
A + B + C + D	15,9	a 18

Use shims to adjust cut width: MIN 1,1mm - MAX 1,7mm

I mm	D mm	H mm	L mm		ORDER NO. S=Ø12mm	ORDER NO. S=Ø12,7mm
3,2-18	47,6	12,8	81	10	900.506.11	
3,2-18	47,6	12,8	81	10		800.506.11

Spare parts: **541.515.00** 0,1mm spacer
541.517.00 0,5mm spacer
541.518.00 1mm spacer
541.501.00 4mm spacer

Optional: **791.711.00** 2 pcs bearing set for depth variations 28,5mm and 34,9mm

Spare parts

924.128.00	791.005.00	990.020.00
824.128.00	791.005.00	990.020.00

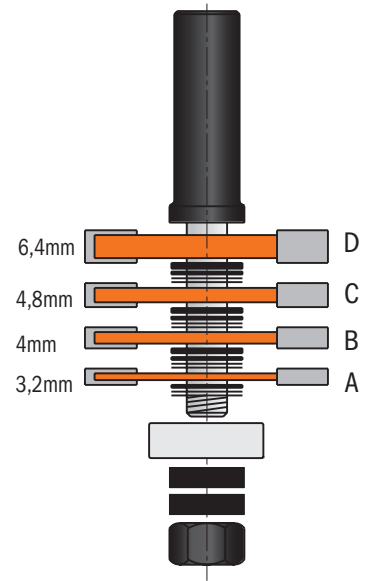

Tongue & Groove Set

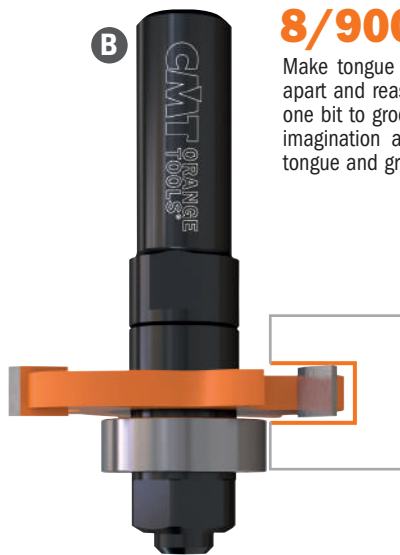
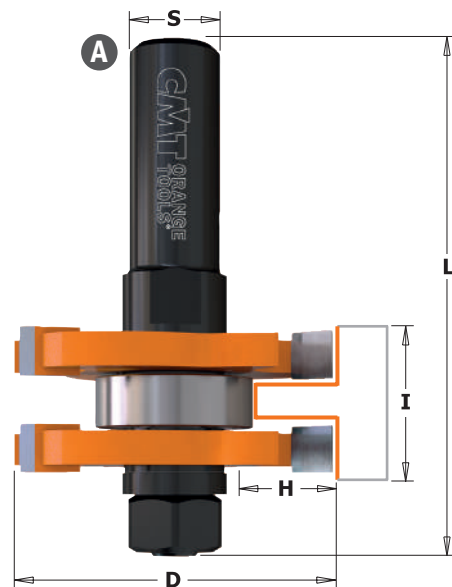

8/900.626



Make tongue and groove joints without the complicated process of taking apart and reassembling bits. The new CMT tongue and groove set gives you one bit to groove the slot and a separate bit to mill the tongue. Or use your imagination and put them to work individually on other projects. Makes tongue and groove cuts in wood up to 19mm thickness.

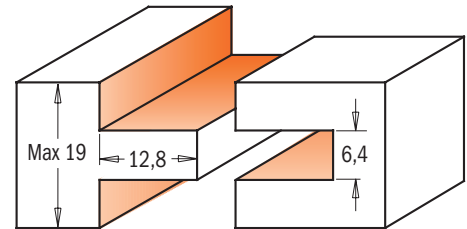

PROFILE	I mm	D mm	H mm	L mm		ORDER NO. S=Ø8mm	ORDER NO. S=Ø12mm	ORDER NO. S=Ø12,7mm
A+B	19	47,6	12,8	71	5	900.126.11		
A+B	19	47,6	12,8	71	5		900.626.11	
A+B	19	47,6	12,8	71	5			800.626.11
A	19	47,6	12,8	71	10			800.626.11M

Spare parts: **541.515.00** 0,1mm spacer
541.516.00 0,3mm spacer
541.517.00 0,5mm spacer
541.518.00 1mm spacer
541.500.00 3mm spacer

Spare parts

924.083.00	791.005.00	822.364.11	990.020.00
924.131.00	791.005.00	822.364.11	990.020.00
824.131.00	791.005.00	822.364.11	990.020.00
824.131.00	791.005.00	822.364.11	990.020.00



7/8/922A/B

Uses for the CMT 3-Wing Slot Cutter are almost infinite. Cut slots and grooves for splines, biscuits, T-molding or tongue and groove joints.

Every cutter features 3 tungsten carbide tipped cutting edges, CMT's trademark orange non-stick P.T.F.E. coating and boasts an anti-kickback design. CMT slot cutters are available as a blade only or with your choice of a 6, 8, 12, 6,35 or 12,7mm diameter arbor which includes a 22mm diameter bearing for a cutting depth of up to 12,7mm. Other bearings are available in the spare parts section of this catalogue.

NOTE: For 9,5mm or 6,35mm depths, you can order the bearing kit **791.711.00** (with 28,5mm - 34,9mm diameters).

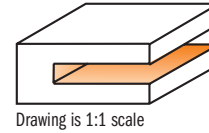
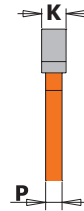
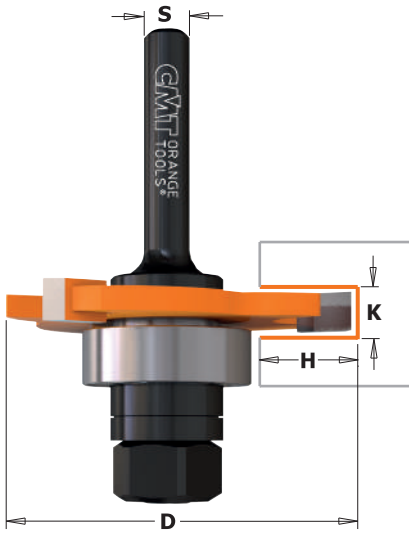

K mm	P mm	D mm	H mm		ORDER NO. S=Ø6mm	ORDER NO. S=Ø6,35mm	ORDER NO. S=Ø8mm	ORDER NO. S=Ø12mm	ORDER NO. S=Ø12,7mm
1,5	1,1	47,6	12,8	10	722.315.11A		922.315.11A	922.315.11B	
1,6	1,1	47,6	12,8	10		822.316.11A			822.316.11B
2	1,3	47,6	12,8	10	722.320.11A	822.320.11A	922.320.11A	922.320.11B	822.320.11B
2,4	1,3	47,6	12,8	10		822.324.11A			822.324.11B
2,5	1,3	47,6	12,8	10	722.325.11A		922.325.11A	922.325.11B	
3	1,3	47,6	12,8	10	722.330.11A		922.330.11A	922.330.11B	
3,2	1,3	47,6	12,8	10		822.332.11A			822.332.11B
3,5	2,1	47,6	12,8	10	722.335.11A		922.335.11A	922.335.11B	
4	2,1	47,6	12,8	10	722.340.11A	822.340.11A	922.340.11A	922.340.11B	822.340.11B
4,8	2,9	47,6	12,8	10		822.348.11A			822.348.11B
5	2,9	47,6	12,8	10	722.350.11A		922.350.11A	922.350.11B	
6	4,5	47,6	12,8	10	722.360.11A	822.360.11A	922.360.11A	922.360.11B	822.360.11B
6,4	4,5	47,6	12,8	10		822.364.11A			822.364.11B

These 3-wing tungsten carbide tipped cutters feature anti-kickback design and CMT's trademark orange P.T.F.E. Industrial Coating. All cutters feature an 8mm bore. Use these cutters with cutter arbors **724** (Ø6mm diameter), **824** (Ø6,35mm & Ø12,7mm diameters), and **924** (Ø8mm & Ø12mm diameters).

1 7/8/924.xxx.00

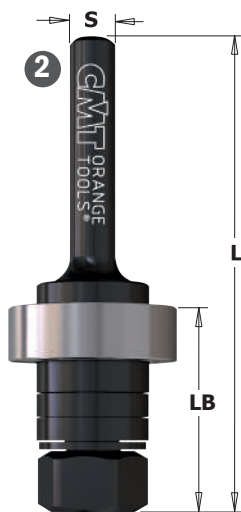

7/8/924.xxx.10

822

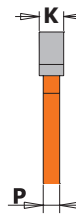
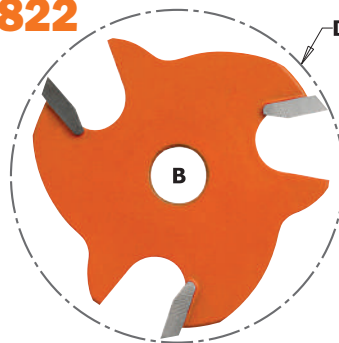

K mm	P mm	D mm	B mm		ORDER NO.
1,5	1,1	47,6	8	10	822.315.11
1,6	1,1	47,6	8	10	822.316.11
1,8	1,3	47,6	8	10	822.318.11
2	1,3	47,6	8	10	822.320.11
2,2	1,3	47,6	8	10	822.322.11
2,4	1,3	47,6	8	10	822.324.11
2,5	1,3	47,6	8	10	822.325.11
2,8	1,3	47,6	8	10	822.328.11
3	1,3	47,6	8	10	822.330.11
3,2	1,3	47,6	8	10	822.332.11
3,5	2,1	47,6	8	10	822.335.11
4	2,1	47,6	8	10	822.340.11
4,8	2,9	47,6	8	10	822.348.11
5	2,9	47,6	8	10	822.350.11
6	4,5	47,6	8	10	822.360.11
6,4	4,5	47,6	8	10	822.364.11

DESCRIPTION	LB mm	L mm		ORDER NO. S=Ø6mm	ORDER NO. S=Ø6,35mm	ORDER NO. S=Ø8mm	ORDER NO. S=Ø12mm	ORDER NO. S=Ø12,7mm
1 Slot cutter arbor without bearing	26	61	10	724.060.00	824.064.00	924.080.00		
1 Slot cutter arbor without bearing	26	67,5	10				924.120.00	824.127.00
2 Slot cutter arbor with bearing	26	61	10	724.060.10	824.064.10	924.080.10		
2 Slot cutter arbor with bearing	26	67,5	10				924.120.10	824.127.10
Slot cutter arbor without bearing, long series	40	86	10			924.083.00		
Slot cutter arbor with bearing, long series	40	86	10			924.083.10		

Spare parts: **791.005.00** Ø8-22mm bearing
541.501.00 4mm spacer
541.500.00 3mm spacer

541.518.00 1mm spacer
990.020.00 M8 nut

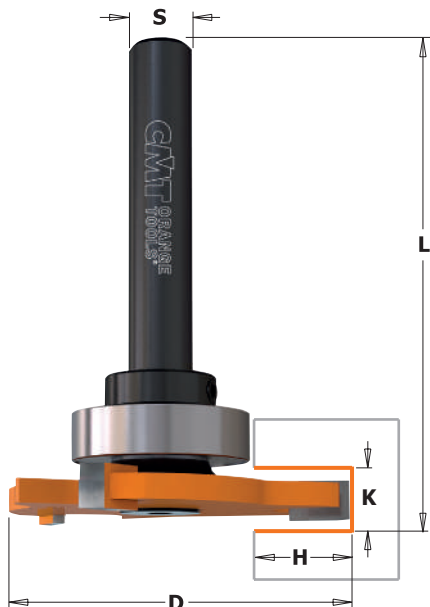

923A - 823B

The uses of this bit are infinite: not only can you rout grooves and rabbets, but you can even create T or dovetail joints and create biscuit and spline recesses on wood panels. Each bit features three carbide-tipped cutters, orange coloured P.T.F.E. coating and anti-kick-back design.

NOTE: This cutter comes with a Ø22mm bearing for 2,8mm depth cuts. By ordering different bearings this depth can be shortened.

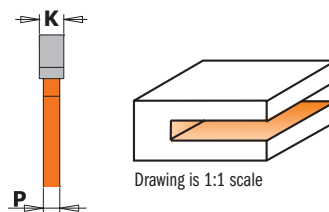

K mm	P mm	D mm	H mm	L mm	Box	ORDER NO. S=Ø8mm	ORDER NO. S=Ø12,7mm
3	1,3	47,6	12,8	58	10	923.330.11A	
3,2	1,3	47,6	12,8	57,5	10		823.332.11B
4	2,1	47,6	12,8	58,3	10	923.340.11A	823.340.11B
5	2,9	47,6	12,8	63	10	923.350.11A	
6,4	4,5	47,6	12,8	60,7	10		823.364.11B

823

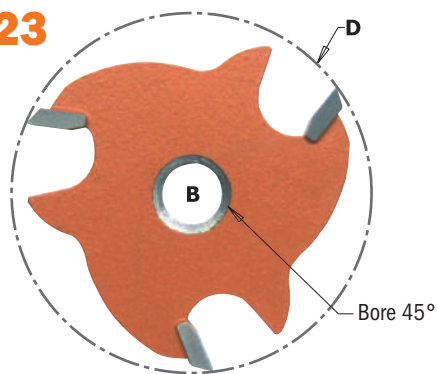

These 3-wing carbide tipped slot cutters feature anti-kickback design and CMT's trademark orange P.T.F.E. Industrial Coating for carrying out lateral grooves. For use with cutter arbors **724** (Ø6mm), **824** (Ø6,35mm & Ø12,7mm) and **924** (Ø8mm).

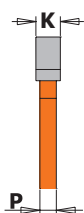

K mm	P mm	D mm	B mm	Box	ORDER NO.
3	1,3	47,6	8	10	823.330.11
3,2	1,3	47,6	8	10	823.332.11
4	2,1	47,6	8	10	823.340.11
5	2,9	47,6	8	10	823.350.11
6,4	4,5	47,6	8	10	823.364.11

7/8/924



8/924



Assembly Illustration

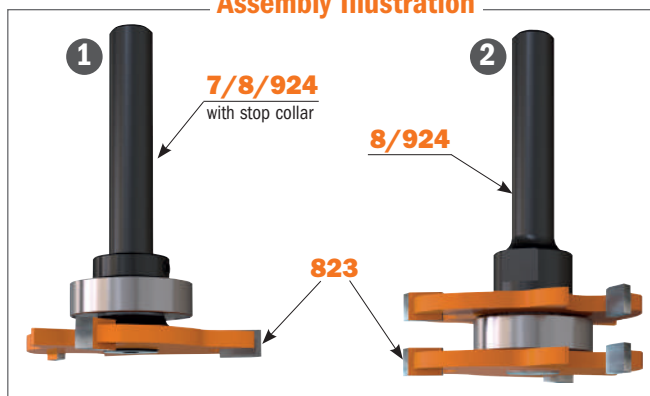

DESCRIPTION	Box	ORDER NO. S=Ø6mm	ORDER NO. S=Ø6,35mm	ORDER NO. S=Ø8mm	ORDER NO. S=Ø12,7mm
1 Slot cutter arbor without bearing without stop collar	10	724.061.00	824.061.00	924.081.00	824.121.00
1 Slot cutter arbor with bearing and stop collar	10	724.061.10	824.061.10	924.081.10	824.121.10
2 Slot cutter arbor without bearing	10			924.082.00	824.122.00
2 Slot cutter arbor with bearing	10			924.082.10	824.122.10

Spare parts:
791.012.00 Ø8-22mm bearing
541.001.00 Stop collar for Ø6,35mm shanks
541.002.00 Stop collar for Ø12,7mm shanks
791.013.00 Ø12,7-22mm bearing
541.003.00 Stop collar for Ø6mm shanks
541.004.00 Stop collar for Ø8mm shanks

541.515.00 0,1mm spacer
541.516.00 0,3mm spacer
541.517.00 0,5mm spacer
541.518.00 1mm spacer
990.055.00 M5x12mm TSPEI screw
991.067.00 3mm hex key

Flute & Bead Set

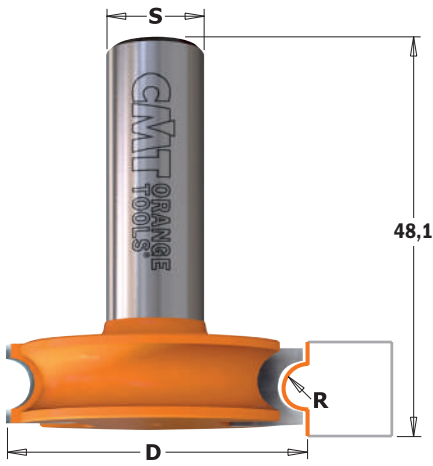

8/955.701

This perfectly mated CMT set is ideal for making wooden canoe slats and hot tub enclosures. The cutting edges in tungsten carbide stay sharp even after cutting large amounts of stock. The anti-kickback design ensures that you work safely. Use both the flute and the bead bits for 6,35mm (1/4") slats as shown below.

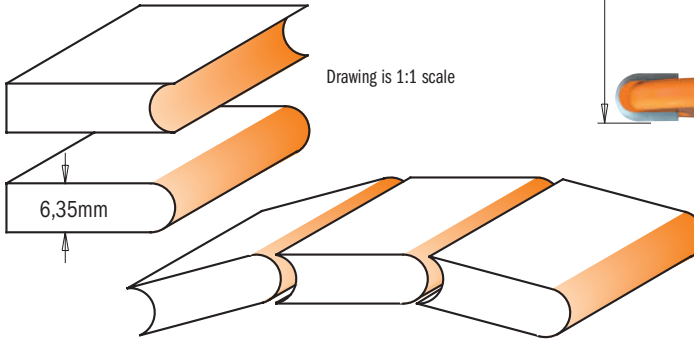

R mm	D mm					ORDER NO. S=Ø12mm	ORDER NO. S=Ø12,7mm
3,2	38			5		955.701.11	855.701.11

Lock Miter Set

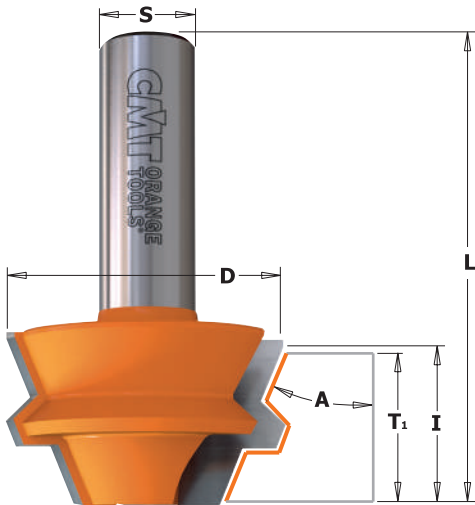

8/955

Use this pair of bits to produce octagonal shaped boxes and popular corner cabinetry for kitchens, kitchen islands, entertainment centres and corner hutches.

This 22.5° Lock Miter set provides a strong tight joint even at 45° angles.

After the joints are machined, they can be glued and assembled or simply clamped by using strapping tape.

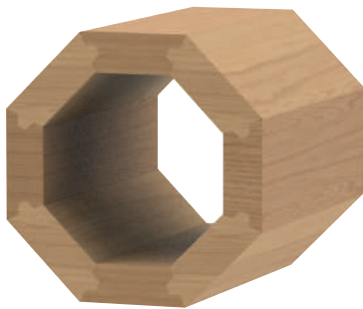
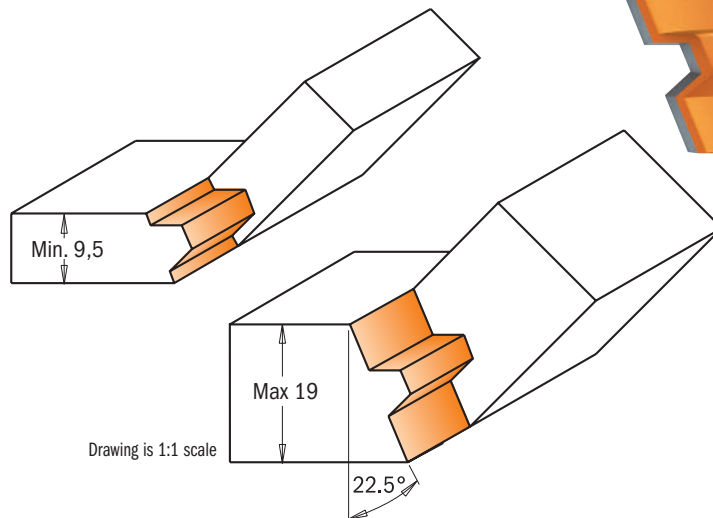
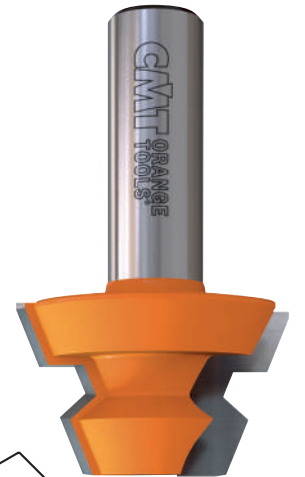

D mm	I mm	A	T ₁ mm	L mm			ORDER NO. S=Ø8mm	ORDER NO. S=Ø12,7mm
37,3	22,2	22.5°	9,5 ÷ 19	60,3		5	955.005.11	855.505.11



8/955.504

These are the ultimate bits to craft sturdy miter joints thanks to anti-kickback design and tough tungsten carbide cutting edges. By adding a second smaller bit, you can mill anywhere from 9,5mm to 28,5mm in thickness. A quick and easy way to accurately create boxes, stretcher bars, frames and any assortment of right angle or parallel joint projects.

You also have the advantage of using the same bit for parallel joinery projects. To mill sturdy parallel glue joints follow step 1 shown in the illustration with the inside face of the workpiece laid flat on the table and centred to the bit. To make the second part, lay the workpiece flat on the table and centred to the bit. Mill with the inside face-up.

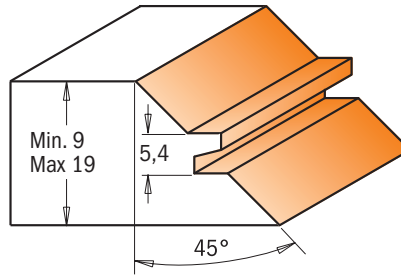

8/955.503

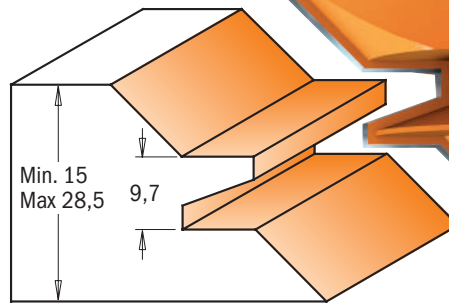

Drawing is 1:1 scale

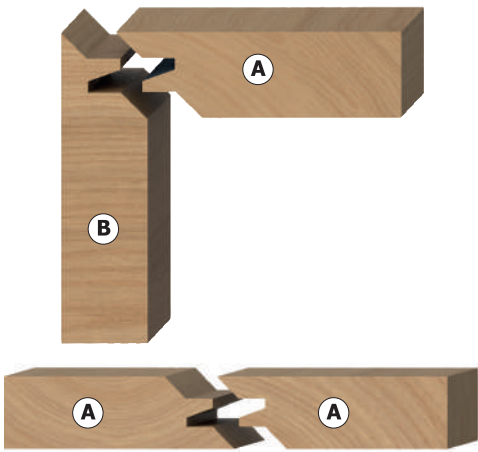

FOR MITER AND PARALLEL GLUE JOINTS USING 19MM BOARD

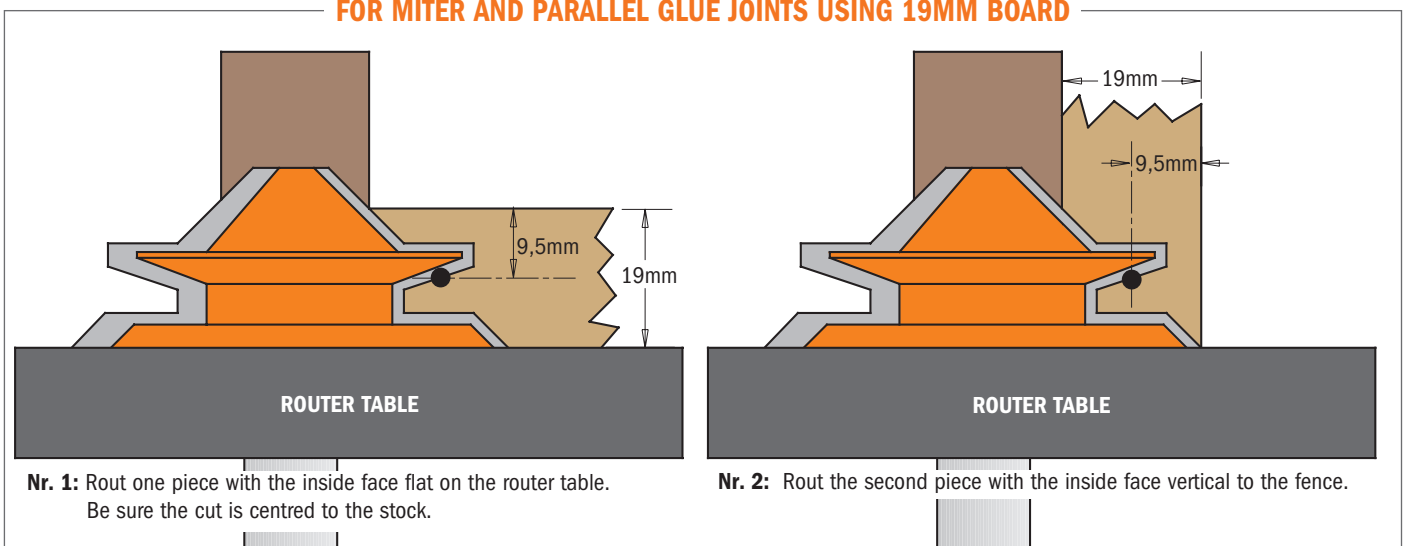

Nr. 1: Rout one piece with the inside face flat on the router table. Be sure the cut is centred to the stock.

Nr. 2: Rout the second piece with the inside face vertical to the fence.

D mm	I mm	A	T ₁ mm	L mm		ORDER NO. S=Ø8mm	ORDER NO. S=Ø12mm	ORDER NO. S=Ø12,7mm
44,5	19	45°	9 ÷ 18	58	5	955.009.11		
50,8	21	45°	9,5 ÷ 19	60,3	5		955.504.11	855.504.11
70	30	45°	15 ÷ 28,5	70	5		955.503.11	855.503.11

Reverse Glue Joint Bits



8/955.501

The most unique and important characteristic of this CMT bit is its capacity to produce a virtually indestructible glue joint quickly and flawlessly. Ideal for routing panels, doors and furniture pieces of wide dimension, panels, doors and furniture pieces. Refer to page 238, "ABCs of Panel Door Construction".

By accurately centering the bit to the wood, the upper and lower vertical cutting edges of the bit will cut equal proportions. Simply run one edge of the panel, turn the panel over, and then run the opposite edge - you will craft perfectly harmonized reverse cuts that match up to produce immaculate joints!

SHOP TIPS: When glueing, apply enough pressure to securely seal the joint. Insufficient pressure results in a weak joint and excessive pressure will distort the wood.

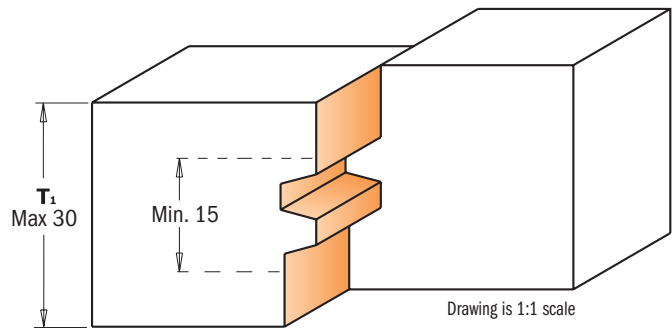
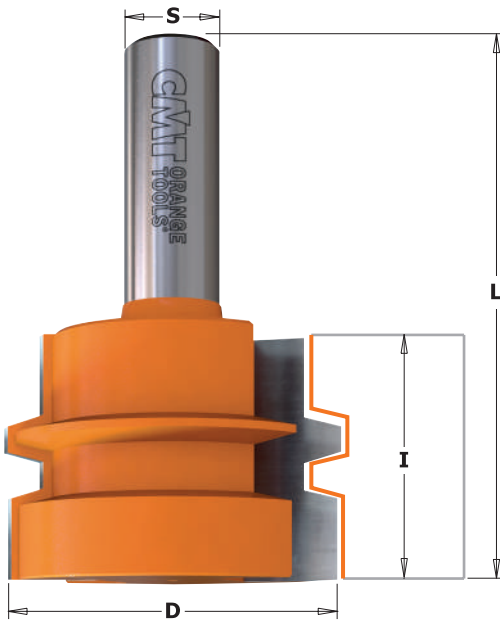

EXAMPLE USING A 19MM BOARD

Accurately centre the wood to the bit: Adjust the bit according to the thickness of the wood you are cutting. Line up the cut edge of the wood to the centre point of the bit as illustrated in the enlarged drawing. The upper and lower vertical cutting edges of the bit are in proportion and at an equal distance from the centre point of the bit. Run one cut edge of the wood, turn the piece over and run the other edge for exact reverse cuts that match up perfectly. Assemble the reverse cut pairs together for beautiful, strong joints.

D mm	I mm	T ₁ mm	L mm		ORDER NO. S=Ø12mm	ORDER NO. S=Ø12,7mm
44,4	32	15 - 30	70,1	10	955.501.11	855.501.11

7/8/955



With CMT drawer lock bits you can make strong, perfectly fitted joints quickly and easily. Follow the example below to create perfect drawers.

WARNING! These bits are to be used on router tables only with a fence. Do not use on hand-held routers.

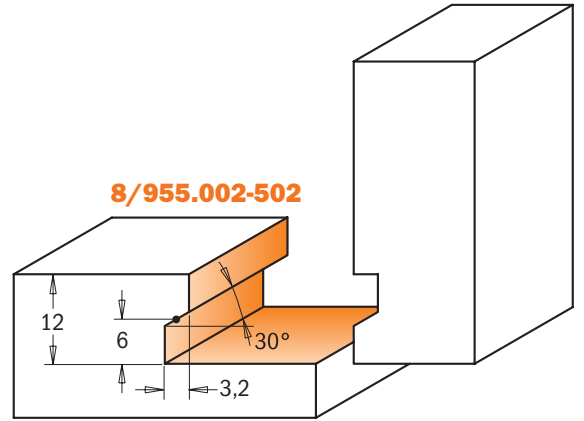
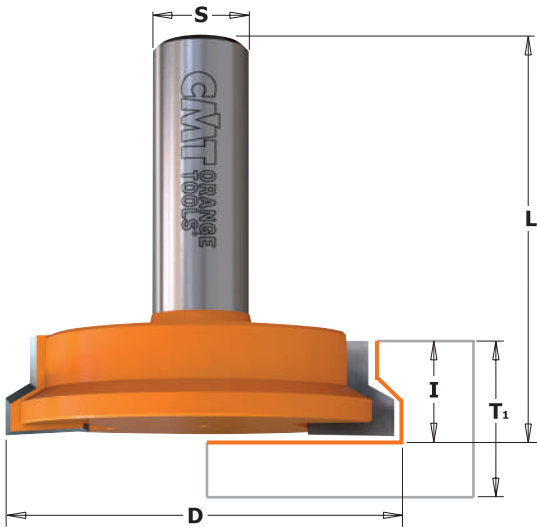

Drawing is 1:1 scale

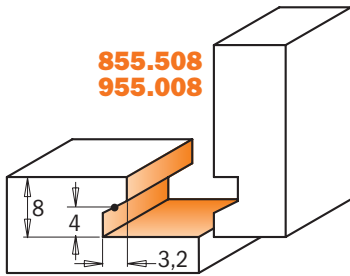

Drawing is 1:1 scale

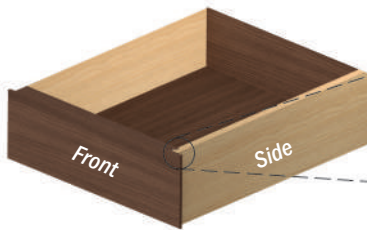
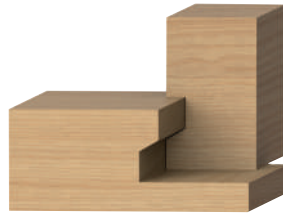

Overhang for drawer stop

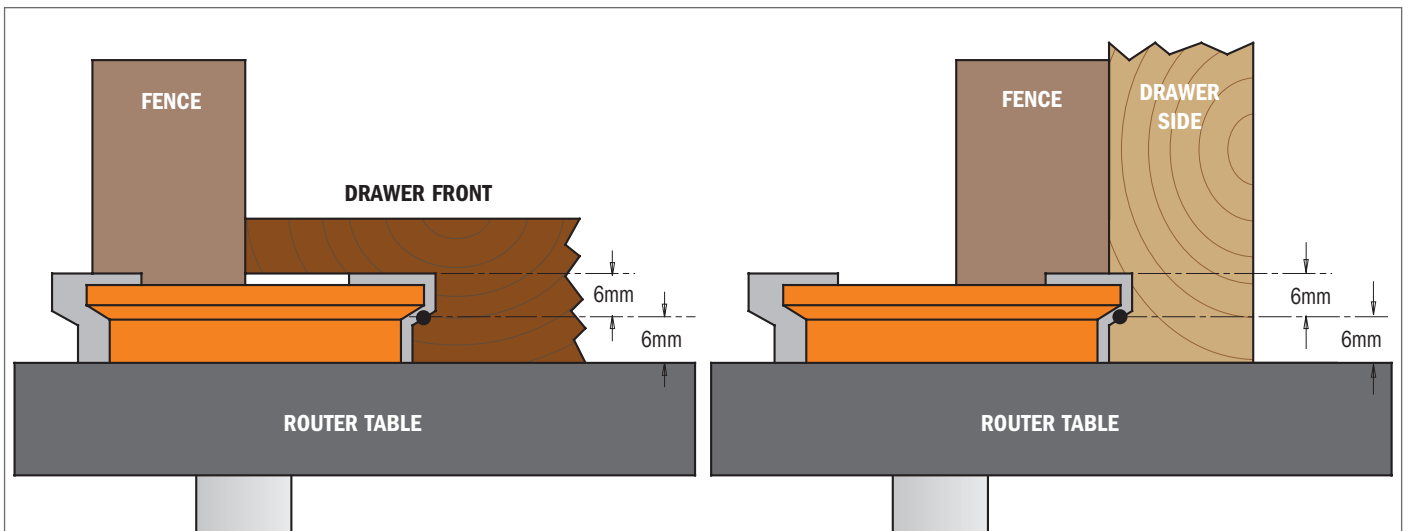
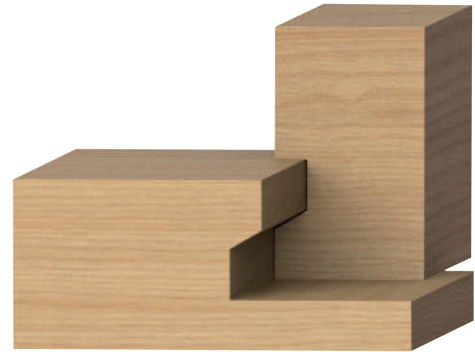

D mm	T ₁		I mm	L mm	Box Icon	ORDER NO. S=Ø6mm	ORDER NO. S=Ø6,35mm	ORDER NO. S=Ø8mm	ORDER NO. S=Ø12mm	ORDER NO. S=Ø12,7mm
	min. mm	max. mm								
25,4	9,5	15,87	12,7	54	10			955.008.11		855.508.11
31,7	15,87	25,4	12,7	44,5	10	755.002.11	855.002.11	955.002.11		
50,8	15,87	25,4	12,7	50,8	10				955.502.11	855.502.11

Window Sash Set



8/955.801

CMT designed this set so you can create window sashes that are as beautiful as they are functional. You can craft perfect 12,7mm profiles for custom doors.

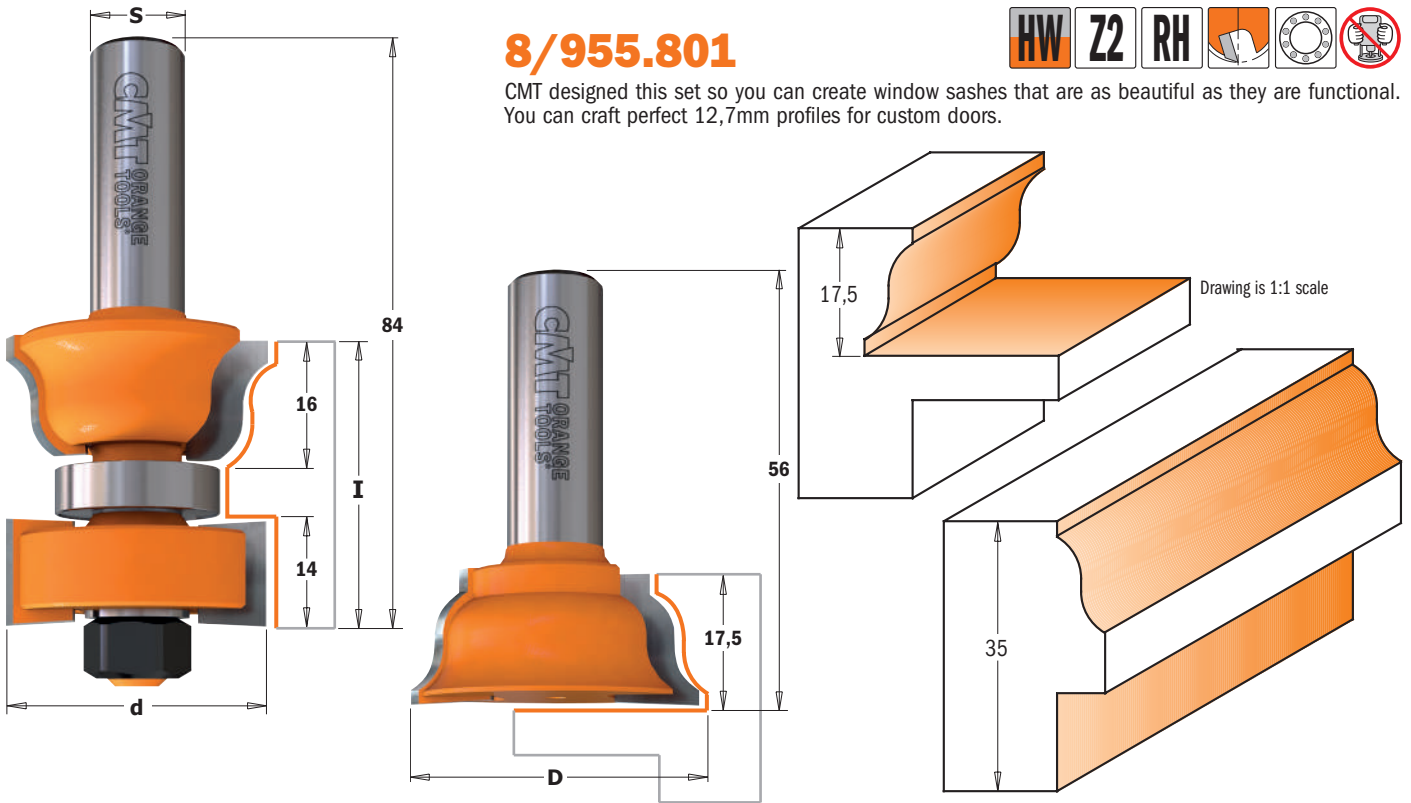

d mm	l mm	L mm	D mm	l mm	L mm		ORDER NO. S=Ø12mm	ORDER NO. S=Ø12,7mm
35	35	84	38	17,5	56	5	955.801.11	855.801.11

Spare parts

791.012.00	822.004.11	541.518.00	990.020.00

STEP-BY-STEP WINDOW SASH CONSTRUCTION

CMT set makes it easy!

In our step-by-step example for window sash construction, we used the following:

- CMT Window Sash Set (item #855.801.11)
- stiles cut 35mm thick
- rails cut 35mm thick
- scrap stock

The CMT Window Sash Set was designed ideally for the construction of windows in 35mm stock, however variations as narrow as 28mm can be used. Stock thicker than 35mm exceeds the milling range of the cutter. Remember to adjust your measurements and cutting depths according to the wood thickness you use. We suggest making a trial joint in scrap stock according to the following steps before milling all of the cope and stick Profiles.

STEP 1 - Measurements and making the tenons

The ideal thickness of the stiles when using the CMT sash set is 35mm. The desired width of the stiles will determine the length you need to make your tenons, while the length of the stile will represent the desired full height of the sash. When cutting the rails to length, make sure to add the length of the two tenons to the overall length of the rail. The length of the tenons should be at least half the width of the stile. Mill 16mm measuring from the front face of the stock using a table saw, radial saw or router as shown in illustration 1. This measurement remains invariable since it is calculated to the height of the CMT sash routers. The width of the tenon is 6mm. Rotate the stock and mill the other side. As per our example, the second milling will be 13mm but this measurement will vary if you are using thinner stock.

STEP 2 - Making the cope Profilee on rails, sash bar and muntins

To make the cope Profilee, place the rail face front down on the router table with the tenon flush to the bit as shown in illustration 2. Adjust the fence so the bit mills 6,35mm deeper than the tenon. To mill the sash bar and the muntins (cross bars), position front face down on the router table and mill without changing the height of the bit.

STEP 3 - Making the stick Profilee on rails, stile, sash bar and muntins

To mill the stick Profilee along the inside edges of all sash parts, place the already milled cope Profilee front face down on the router table and adjust the sash bit so that the lower edge of the top cutter will exactly touch the upper edge of the tenon as shown in need to 3 illustrations. With the rail still face down on the table, turn it so the inside edge of the rail is touching the bit and mill the stick Profilee. Mill the inside edges of the stiles and mill both edges of the front face of the sash bar and muntins. To cut the slots for the tenons, measure 16mm from the front face of the stiles and rout with a table saw.

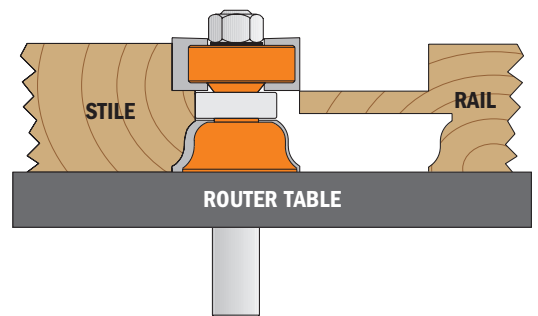
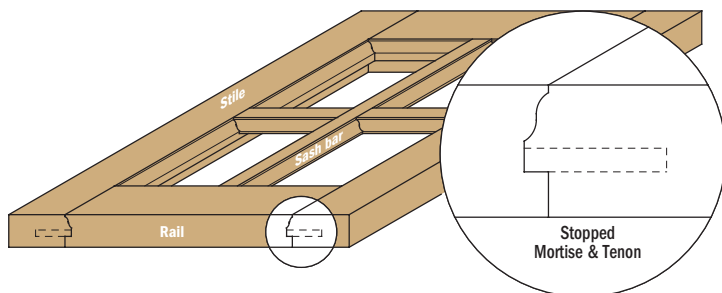
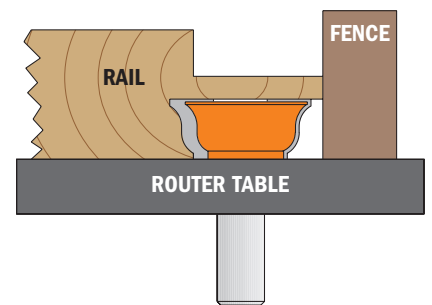
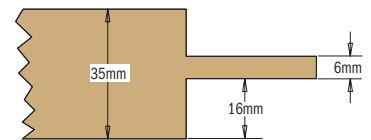

Ovolo Sash Bits

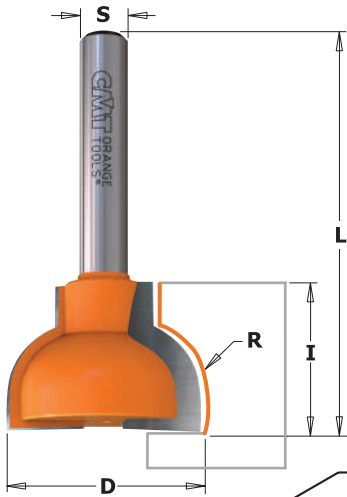

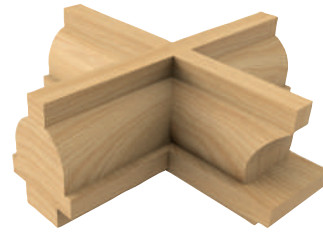

8/955.3

These bits allow you to make true divided light doors for fine furniture and cabinets as well as sash bar windows, and stile and rail constructions. The glazing bar ovolo bits are bearing-guided to enable curved frames to be moulded. Cove bits can be used to produce easy-to-pull drawer handles.



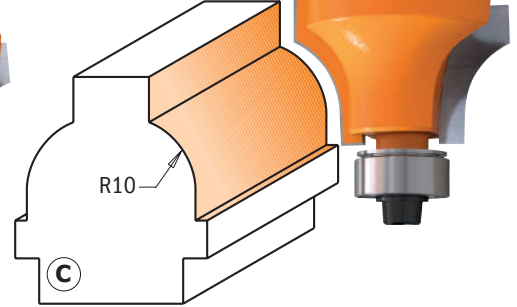
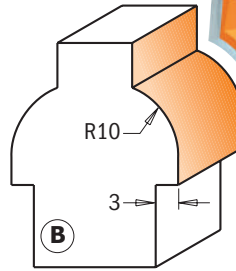
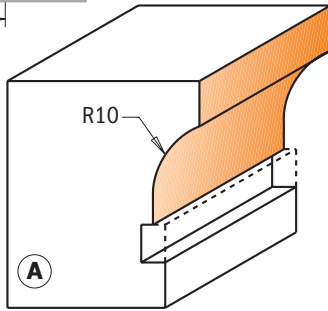



Drawing is 1:1 scale



D mm	I mm	R mm	L mm	PROFILE		ORDER NO. S=Ø6,35mm	ORDER NO. S=Ø8mm
25	19	10	50,8	A	10	855.307.11M	955.307.11M
22	19	10	50,8	B	10	855.307.11F	955.307.11F
28	19	10	61,2	C	10	855.308.11F	955.308.11F

Spare parts

			
990.423.00	791.003.00	990.058.00	991.057.00

Ovolo Sash Set



955.302 - 855.802

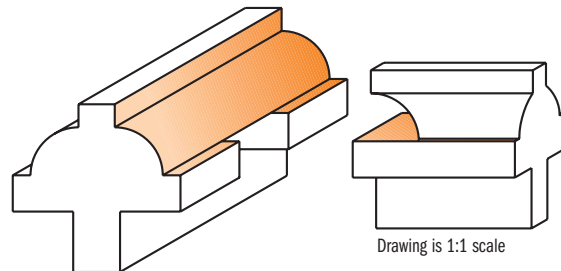
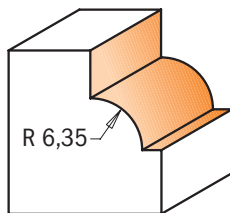
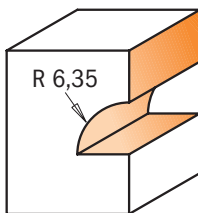
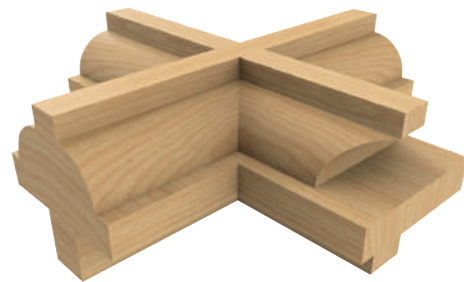

Drawing is 1:1 scale

d mm	D mm	I mm	R mm		ORDER NO. S=Ø8mm	ORDER NO. S=Ø12,7mm
30	31,7	12	6,35	5	955.302.11	855.802.11

Spare parts

					
990.423.00	791.003.00	990.058.00	991.057.00	791.011.00	541.002.00

Spare parts: 991.056.00 1,5mm hex key

Finger Joint Bit

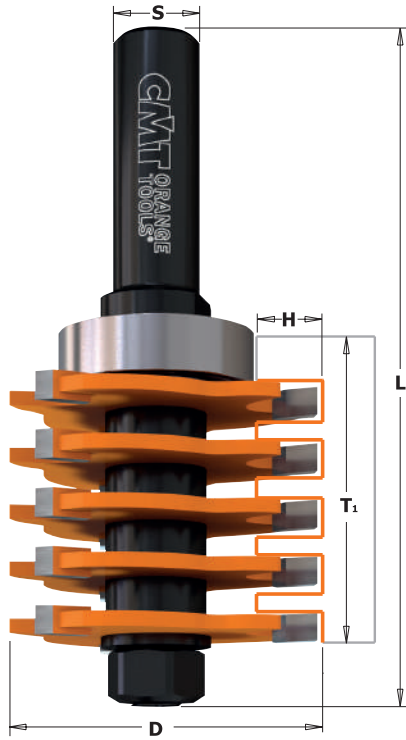

8/900.616



This router allows you to carry out accurate and functional finger joints with the greatest of ease. Without any adjustment you will be able to work woods with different thicknesses as indicated in the drawing. The bearing allows you to reach a 9,5mm cutting depth. For further cutting depths you need to use a fence.

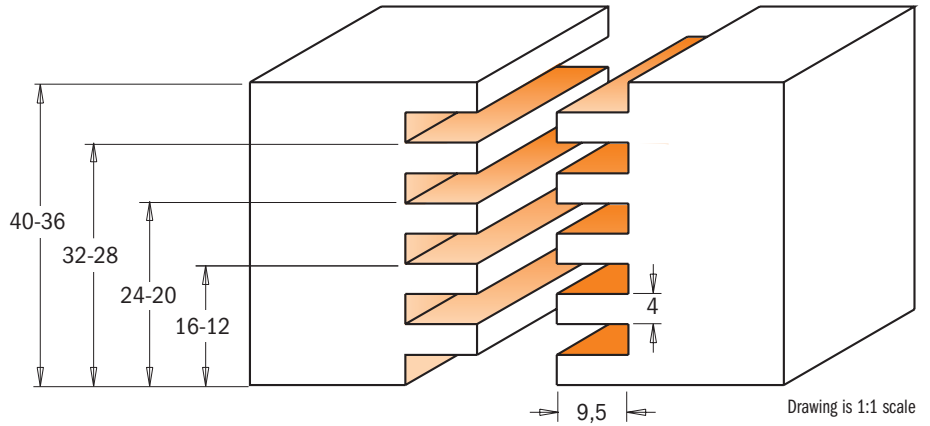

T ₁ mm	D mm	H mm	L mm		ORDER NO. S=Ø12mm	ORDER NO. S=Ø12,7mm
12 - 40	47,6	9,5	97	10	900.616.11	800.616.11
12 - 40	47,6	9,5	97	10		

Spare parts

924.130.00	791.027.00	822.340.11	990.020.00
824.130.00	791.027.00	822.340.11	990.020.00

Spare parts: **541.515.00** 0,1mm spacer
541.519.00 5,8mm spacer
990.403.00 1,6mm washer
990.459.00 Kit with spacers

Optional: **791.020.00** Ø38,1mm bearing (for depth 4,75mm)
791.029.00 Ø34,9mm bearing (for depth 6,35mm)
791.015.00 Ø31,7mm bearing (for depth 8mm)
791.011.00 Ø19mm bearing (for depth 14,3mm)

Professional Finger Joint Bit

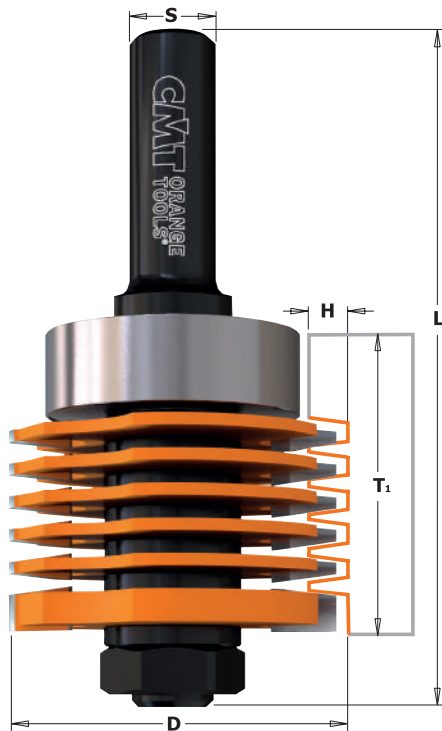

8/900.606



This versatile finger joint bit is the perfect tool for making incredibly strong side-to-side or end-to-end joints in wood and in varying lengths from 12.7mm to 36mm. The tightness and accuracy of the cut joint coupled with the maximum glue surface create a joint that is actually stronger than an unworked piece of wood.

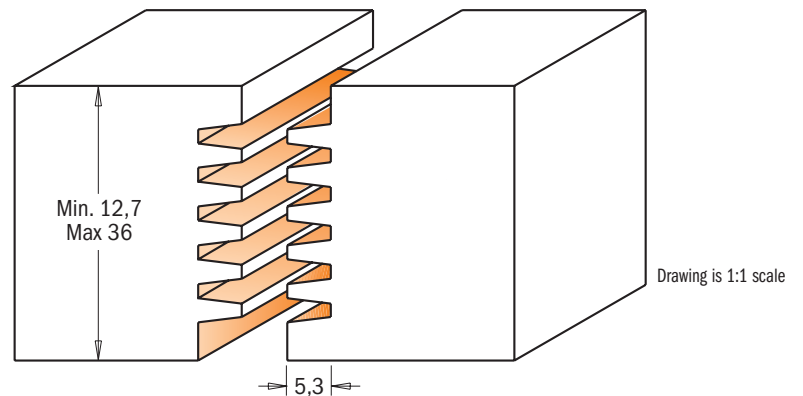

T ₁ mm	D mm	H mm	L mm		ORDER NO. S=Ø12mm	ORDER NO. S=Ø12,7mm
12,7 - 36	47,6	5,3	97	10	900.606.11	800.606.11
12,7 - 36	47,6	5,3	97	10		

Spare parts

824.129.00	791.028.00	822.005.11	990.022.00
924.129.00	791.028.00	822.005.11	990.022.00

Spare parts: **541.511.00** 3mm spacer
541.512.00 2mm spacer
541.526.00 0,1mm spacer
990.458.00 Kit with spacer

V-Tongue & Groove Set

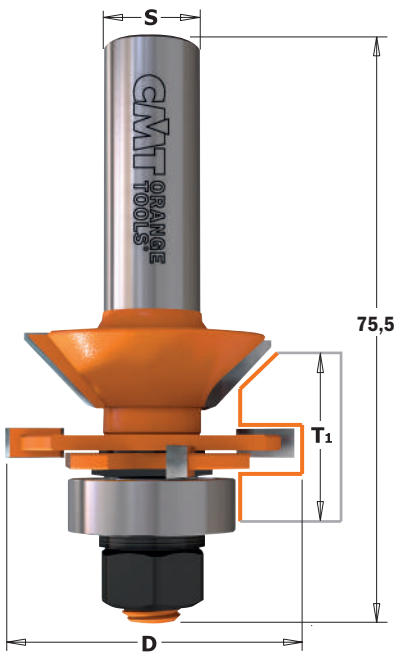

8/955.506

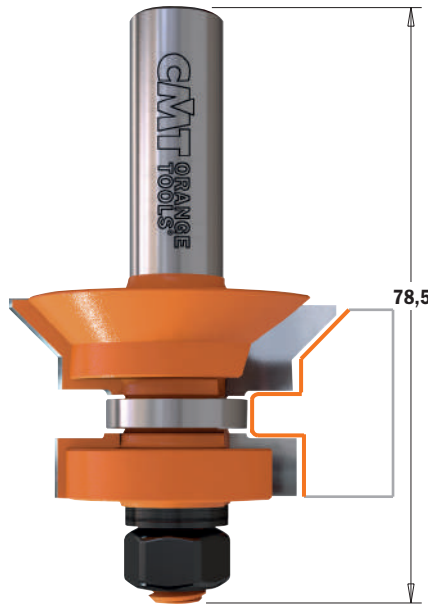

If the standard selection of moulding and mill work you find in today's lumber shops isn't satisfactory to your woodworking tastes, then consider CMT's moulding system instead. With these bits, you can make dozens of elaborate profiles by combining two or more passes. Avoid the average and create your own mouldings. Some initial suggestions are illustrated below.

SAFETY TIPS: use these bits with a fence. The profiles shown below are milled from heavy stock then refined to the desired shape.

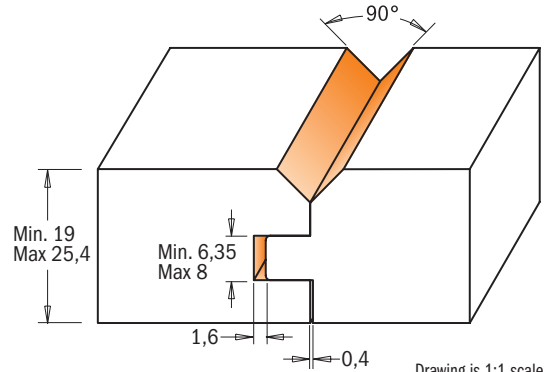

D mm	T ₁ mm		ORDER NO. S=Ø12mm	ORDER NO. S=Ø12,7mm
44,4	19÷25,4	10	955.506.11	855.506.11

Spare parts

822.013.11	822.014.11	791.011.00	791.005.00	990.020.00

Spare parts: 541.515.00 0,1mm spacer
 541.516.00 0,3mm spacer
 541.517.00 0,5mm spacer
 990.407.00 Shield

Edge Banding Bits Set

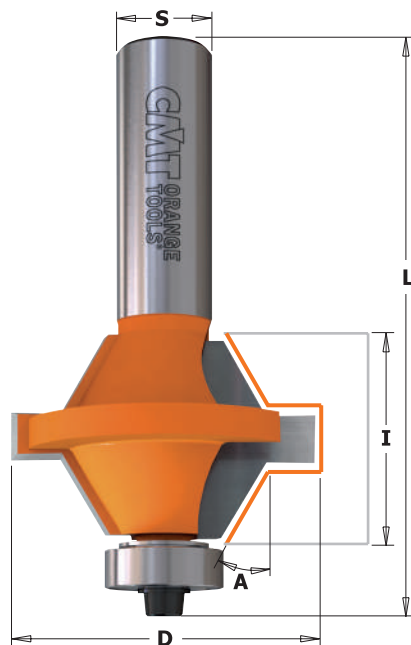

8/955.510



This is a great set to create cost-effective, yet attractive durable edges to your cabinet doors. For use with 12,7mm or 25,4mm thick panels in plywood or MDF. Easy to use: center each cutter on the stock and make the cut; glue the two pieces together; flush trim after assembly, if necessary. The set features a 60° angle tongue & groove with an ample surface area for glue application.

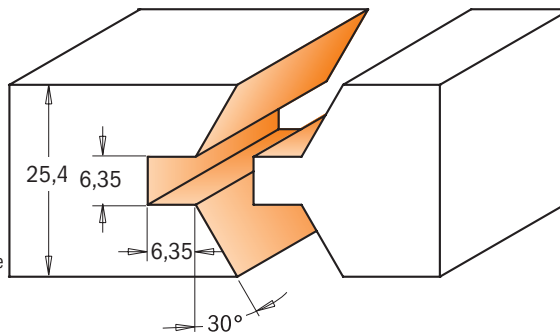

Drawing is 1:1 scale



D mm	I mm	A	L mm		ORDER NO. S=Ø12mm	ORDER NO. S=Ø12,7mm
40	25,4	30°	74,5	5	955.510.11	855.510.11

Spare parts

990.423.00	791.018.00	990.058.00	991.057.00

Dovetail Bits



7/8/918 - 7/818B

The beautifully crafted dovetail joint is a classic that appeals to both professionals and novices alike.

SHOP TIPS: Two passes are recommended when routing dovetails with a template. Check that the dovetails have been cut through completely and smoothly before removing the workpiece. For even easier routing and less stress on your dovetail bit, run the first pass with a straight bit. Use a dovetail on your router table equipped with a fence to achieve difficult chamfer angles.

SAFETY TIPS: If the dovetail bit jams while working, adjust the position of the bit in the collet and ensure the cutting depth is appropriate. Do not lift the router out of the template.

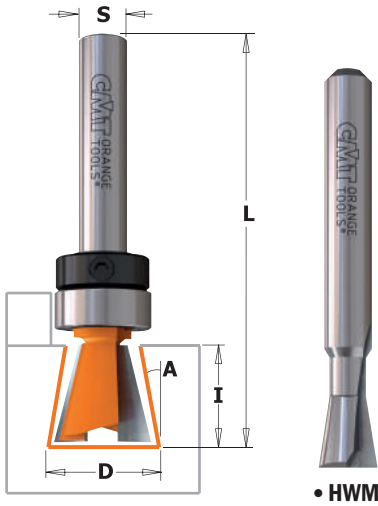

Drawing is 1:1 scale

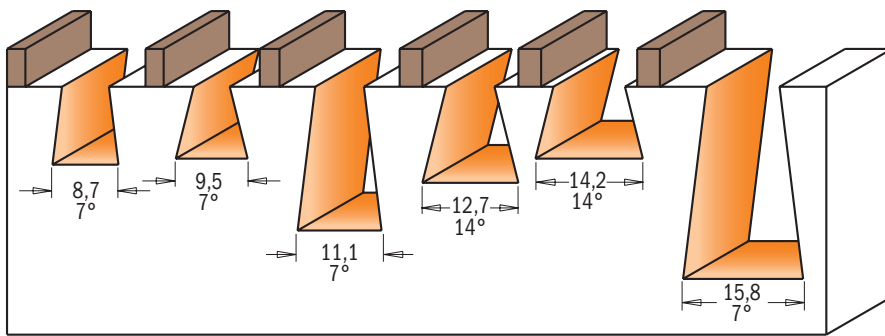
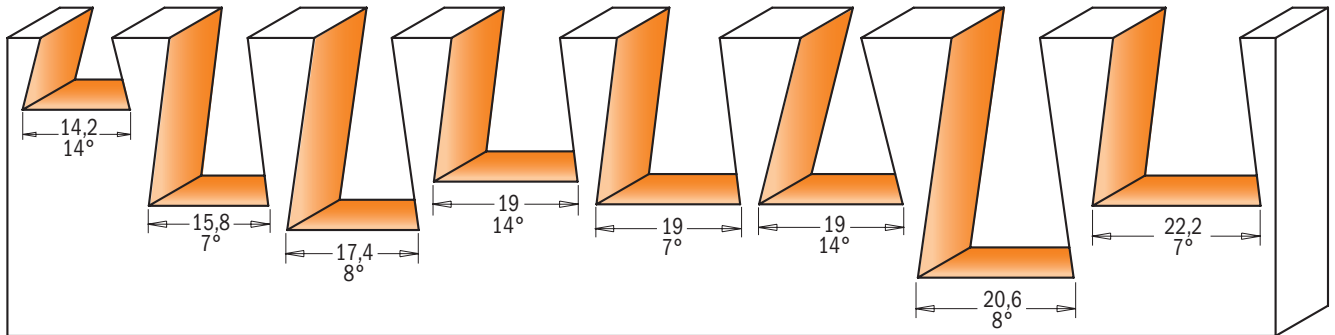
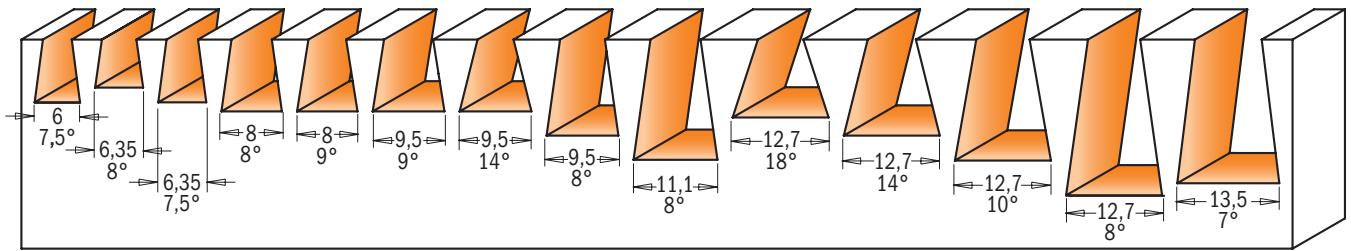

Fit Manufacturer Model	ORDER NO.	
CMT-Enlock10		818.098.11B
CMT-Enlock15	718.127.11B	818.128.11B
CMT300	718.127.11	818.128.11
	918.127.11	818.628.11

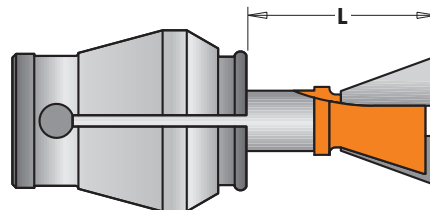
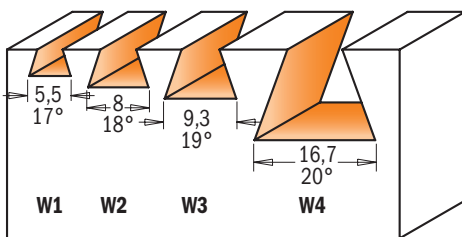

Manufacturer/Model	ORDER NO.	
FIT HOFFMANN® KEYS		
W1 L=16mm	718.053.11	818.053.11
W2 L=17,5mm	718.079.11	818.079.11
W3 L=19mm	718.093.11	818.093.11
W4 L=25mm	918.167.11	

FIT HOFFMANN® KEYS

9° Dovetail Cutters

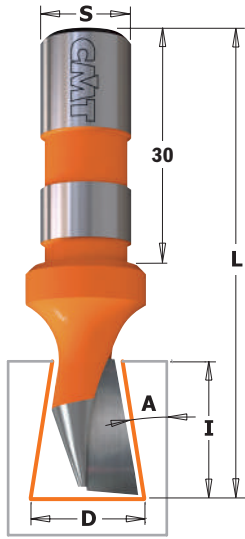

522



D mm	I mm	L mm	A	S mm		ORDER NO. Right-hand rotation
14	18	60	9°	12	10	522.140.11

TECHNICAL DETAILS:

- Super strength steel
- 1 HW precision ground cutting edge [Z1]

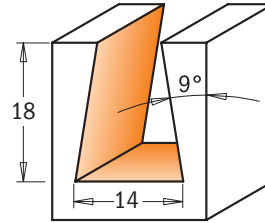

Drawing is 1:1 scale

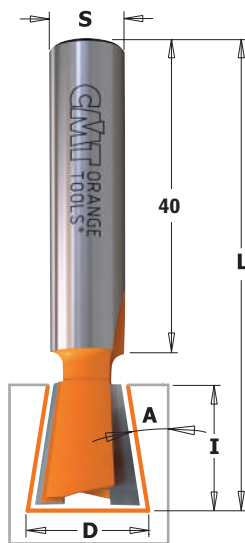

523



D mm	I mm	L mm	A	S mm		ORDER NO. Right-hand rotation
14	16	60	9°	10	10	523.140.11

TECHNICAL DETAILS:

- Super strength steel
- 2 HW precision ground cutting edges [Z2]

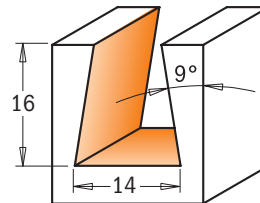

Drawing is 1:1 scale

15° Dovetail Cutter with Insert Knives for Roof-Frames

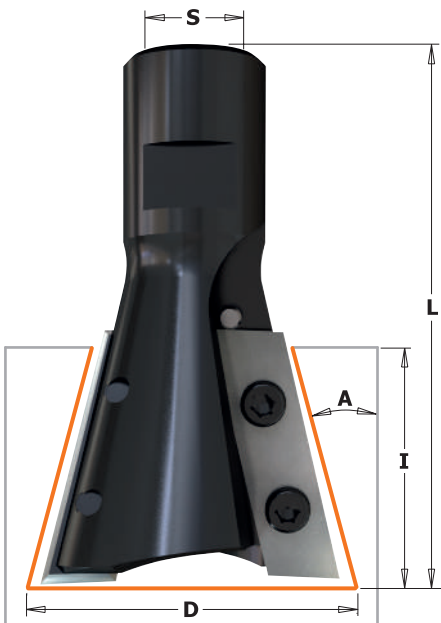

664



D mm	I mm	L mm	A	S mm		ORDER NO. Right-hand rotation
39,5	31,5	66	15°	M12x1	1	664.395.11

TECHNICAL DETAILS:

- Super strength steel
- 2 HWM precision insert knives [Z2]

APPLICATION:

This cutter allows you to assemble roof-frames by dovetailing.

Spare parts

790.315.00	990.076.00	991.061.00

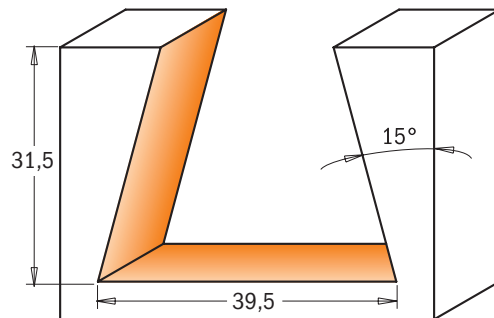

Drawing is 1:1 scale

SAFETY TIPS:

The **TW-006** Torque Screwdriver is recommended for the proper fastening of screws (see page 406).

60° Lettering Bit

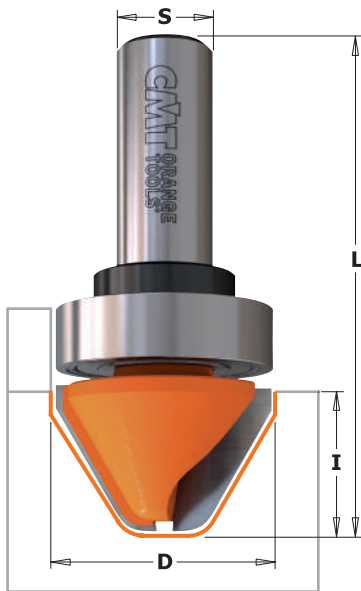

8/949B

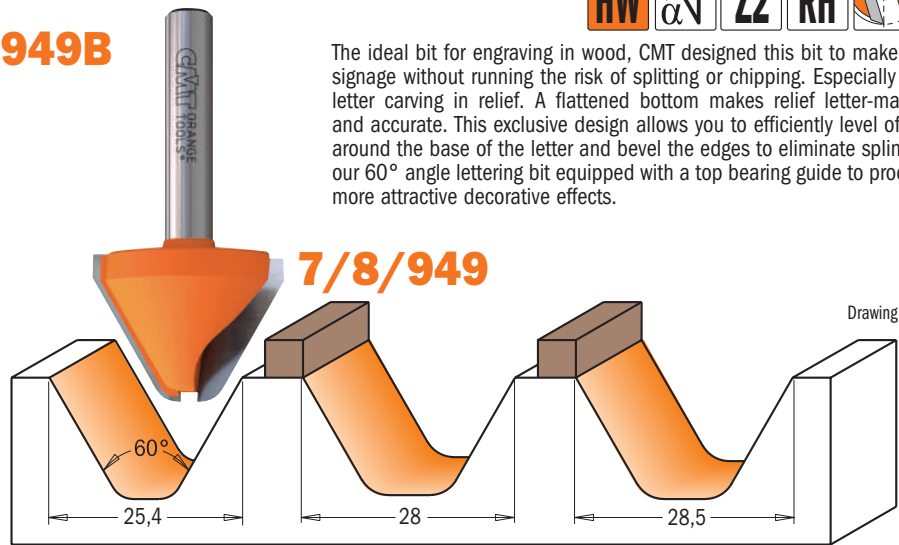

The ideal bit for engraving in wood, CMT designed this bit to make attractive signage without running the risk of splitting or chipping. Especially useful for letter carving in relief. A flattened bottom makes relief letter-making easy and accurate. This exclusive design allows you to efficiently level off the area around the base of the letter and bevel the edges to eliminate splintering. Try our 60° angle lettering bit equipped with a top bearing guide to produce even more attractive decorative effects.

D mm	I mm	A	L mm		ORDER NO. S=Ø6mm	ORDER NO. S=Ø6,35mm	ORDER NO. S=Ø12mm	ORDER NO. S=Ø12,7mm
25,4	19	60°	50,8	10	749.001.11	849.001.11		
28	19	60°	63,5	10			949.502.11	
28,5	19	60°	63,5	10				849.501.11
With top bearing								
28	19	60°	63,5	10			949.502.11B	
28,5	19	60°	63,5	10				849.501.11B

Spare parts		
791.026.00	541.005.00	991.056.00
791.027.00	541.002.00	991.056.00

Spare parts: 990.005.00 M3x3mm STEI screw

Bowl & Tray Bits

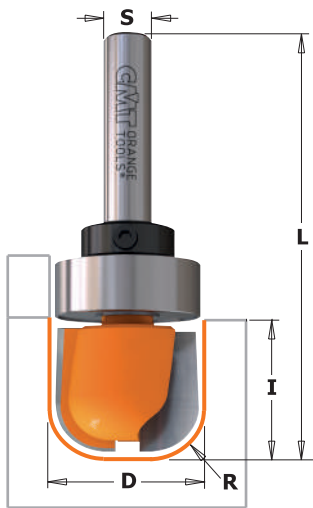

7/8/951B



7/8/951

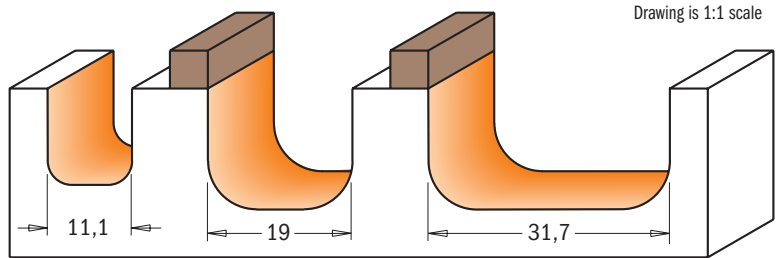

This CMT bit is ideal for making bowls, trays, boxes, cutting boards or any other specialty or craft item. The round corner of the bit shapes the inner radius while the sides and bottom create the smooth flat surfaces. We recommend using a top bearing for accurate and easy pattern work.

Tips: use these bits on a table router with bearing guide for decorative edgework.

D mm	I mm	R mm	L mm		ORDER NO. S=Ø6mm	ORDER NO. S=Ø6,35mm	ORDER NO. S=Ø8mm	ORDER NO. S=Ø12mm	ORDER NO. S=Ø12,7mm
11,1	12,7	3,2	45,5	10		851.001.11			
19	16	6,4	54	10	751.002.11	851.002.11	951.002.11		
19	16	6,4	60,4	10				951.501.11	851.501.11
31,7	16	6,4	60,4	10				951.502.11	851.502.11
With top bearing									
19	16	6,4	54	10	751.002.11B				
19	16	6,4	54	10		851.002.11B			
19	16	6,4	60,4	10					851.501.11B
31,7	16	6,4	60,4	10				951.502.11B	851.502.11B

Spare parts		
791.007.00	541.003.00	991.056.00
791.004.00	541.001.00	991.056.00
791.011.00	541.002.00	991.056.00
791.015.00	541.002.00	991.056.00

Spare parts: 990.005.00 M3x3mm STEI screw

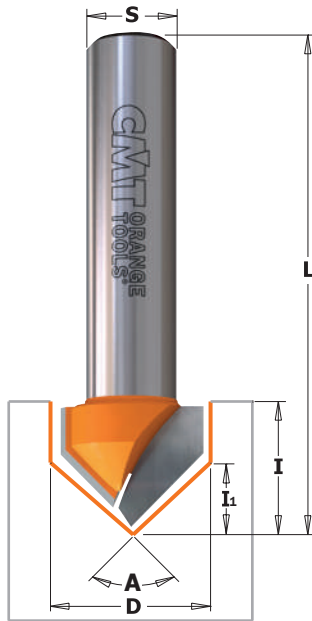

7/8/915



These double cutting edge CMT bits offer an almost endless range of woodworking possibilities. Make clean, perfect cuts in panels, drawer fronts or even plasterboard panels; chamfer edges or engrave beautiful lettering.

TIPS: these bits perfectly chamfer at 45° angles (Two tools in one).

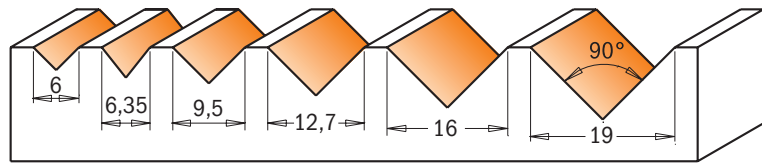

Drawing is 1:1 scale

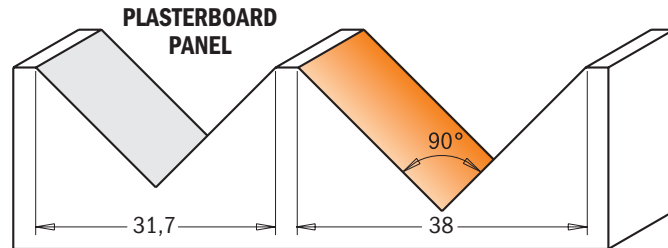

D mm	I mm	I ₁ mm	A	L mm		ORDER NO. S=Ø6mm	ORDER NO. S=Ø6,35mm	ORDER NO. S=Ø8mm	ORDER NO. S=Ø12mm	ORDER NO. S=Ø12,7mm
•6	8	3	90°	46	10	715.060.11		915.060.11		
•6,35	8	3,18	90°	46	10		815.064.11			
9,5	12,7	4,75	90°	44,5	10	715.095.11	815.095.11	915.095.11		
12,7	12,7	6,35	90°	44,5	10	715.127.11	815.127.11	915.127.11		
16	12,7	8	90°	52,8	10			915.160.11		
16	12,7	8	90°	63,5	10				915.660.11	815.660.11
19	16	9,5	90°	55,5	10	715.190.11				
19	16	9,5	90°	63,5	10				915.690.11	815.690.11
31,7	19	15,88	90°	63,5	10			915.317.11	915.817.11	815.817.11
38	28,5	19	90°	63,5	10			915.380.11		
38	28,5	19	90°	70	10					815.880.11

• HWM



7/8/915B



In addition, CMT has versatile top bearing bits that allow for several template options of your choice (see series 715B-815B-915B).

TIPS: these bits perfectly chamfer at 45° angles (two tools in one).

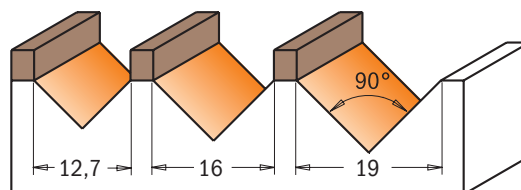

Drawing is 1:1 scale

D mm	I mm	I ₁ mm	A	L mm		ORDER NO. S=Ø6mm	ORDER NO. S=Ø6,35mm	ORDER NO. S=Ø8mm	ORDER NO. S=Ø12,7mm
12,7	12,7	6,35	90°	44,5	10		815.127.11B		
16	12,7	8	90°	52,8	10			915.160.11B	
19	16	9,5	90°	55,5	10	715.190.11B			
19	16	9,5	90°	63,5	10				815.690.11B

Spare parts

791.010.00	541.001.00	991.056.00
791.025.00	541.004.00	991.056.00
791.007.00	541.003.00	991.056.00
791.011.00	541.002.00	991.056.00

Spare parts: 990.005.00 M3x3mm STEI screw

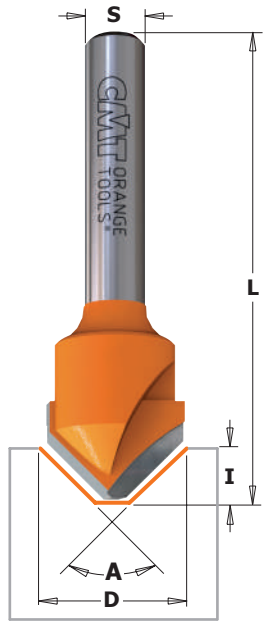

915

ALUCOBOND® panels are an aluminium composite material that can be shaped using a very simple processing method. This technique referred to as the 'routing and folding' method which means paneling can be manipulated to form a variety of shapes and sizes. The advantages of this unique technique are:

- Low investment cost
- Simple fabrication technique
- Folding can be done on site, saving transportation costs
- Low-cost fabrication of shaped components, wall cladding, roof edgings, column cladding, flashings, etc.
- Flexibility in creating shapes
- Very cost effective
- Shapes are not limited by machine capacity.

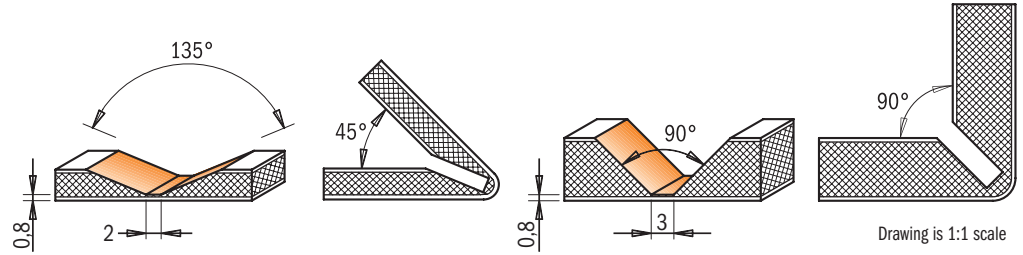

D mm	I mm	A	L mm		ORDER NO. S=Ø6mm	ORDER NO. S=Ø6,35mm	ORDER NO. S=Ø8mm		
18	7,4	90°	60	10	715.001.11	815.001.11	915.001.11		
18	3,3	135°	60	10	715.002.11	815.002.11	915.002.11		

Laser Point Bit



7/8/958



This bit crafts delicate grooves and incisions with laser precision. Make one-of-a-kind effects with 30° bevel edges in one single run. Equipped with three super sharp cutting edges, this perfectly balanced bit allows you to work with incredible accuracy with no risk of burning. Raise the bit and produce a delicate fine point incision, or work the whole 12,7mm diameter to render bold highlighted lettering. Super strong steel shank and micrograin carbide cutting edges guarantee long lasting performance.

7/858.002
• HWM

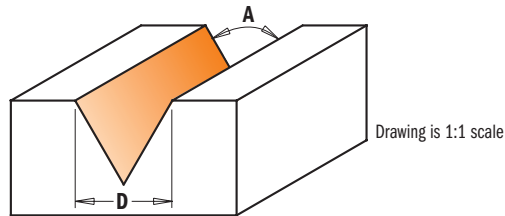

D mm	I mm	A	Z	L mm		ORDER NO. S=Ø6mm	ORDER NO. S=Ø6,35mm	ORDER NO. S=Ø8mm	ORDER NO. S=Ø12,7mm
•6	9	35°	1	50	10	758.002.11			
•6,35	9,5	35°	1	50,8	10		858.002.11		
12,7	11	60°	3	57,2	10	758.001.11	858.001.11	958.001.11	
12,7	11	60°	3	60,3	10				858.501.11
12,7	10	60°	2	50,8	10		858.003.11	958.003.11	

• HWM

V-Grooving & Signmaking Router Bits with indexable knives (90°)



665

These bits have been designed for signmaking and lettering. When the insert shows signs of wear, you can simply rotate it to exploit the other cutting edges. A locking screw secures the insert tightly for added safety and extreme cutting accuracy.

TECHNICAL DETAILS:

- Super strength steel.
- 1 HW precision insert knife [Z1].

SAFETY TIPS:



The **TW-006** Torque Screwdriver is recommended for the proper fastening of screws (see page 406).



CORRECT KNIFE POSITIONING

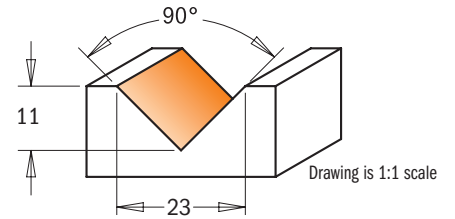
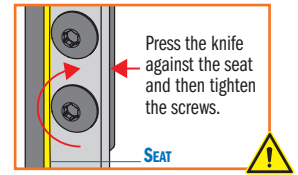

A	D mm	I mm	L mm		ORDER NO S=Ø6,35mm	ORDER NO S=Ø8mm
90°	23	11	60	10	665.201.11	665.200.11

Spare parts

790.280.00	990.093.00	991.073.00

Stepped Rebate Router Bit

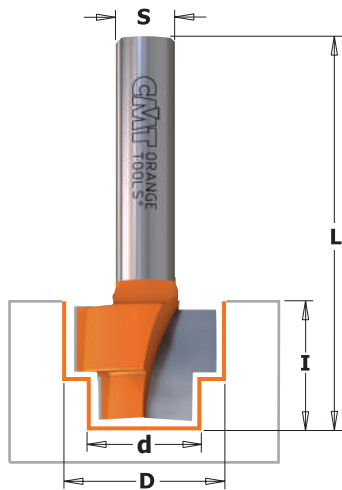

965

Router bit featuring 2 carbide-tipped cutting edges for producing double rebates on wood and wood composites. Designed for accepting library/bookcase shelving strips or for accommodating hardware into your window slots.

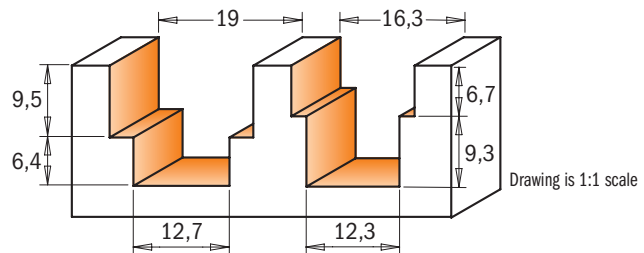

d mm	D mm	I mm	L mm		ORDER NO. S=Ø8mm
12,3	16,3	16	80	10	965.122.11
12,7	19	15,9	50,8	10	965.121.11

Chamfer Bits

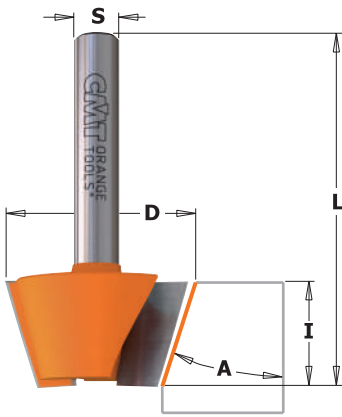

703/4/5 - 903/4/5



From a gently beveled edge to decorative chamfers in a variety of materials, CMT offers smooth results. Deeper cutting length means greater versatility on all bevel dimensions.

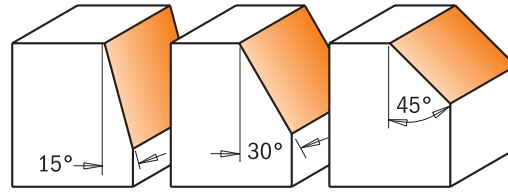

Drawing is 1:1 scale

A	D mm	I mm	L mm		ORDER NO. S=Ø6mm	ORDER NO. S=Ø8mm
15°	24	14	46	10	703.240.11	903.240.11
30°	26	12,7	44,5	10	704.240.11	904.240.11
45°	25	8	41	10	705.240.11	905.240.11

Chamfer Bits with Insert Knives



659



658



Chamfer trim bits feature two replaceable knives fixed by special TORX® screws. The knives are sharpened on all sides and can be resharpened up to three times. For slight bevelled edges or decorative edgework in a variety of materials. Equipped with bearing guides with no need for counterprofiles. For use on portable routers.

SAFETY TIPS:



The **TW-006** Torque Screwdriver is recommended for the proper fastening of screws (see page 406).

CORRECT KNIFE POSITIONING

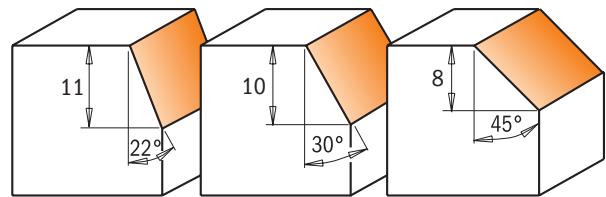
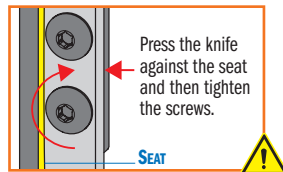

Drawing is 1:1 scale

A	D mm	I mm	L mm		ORDER NO. S=Ø6mm	ORDER NO S=Ø6,35mm	ORDER NO S=Ø8mm	ORDER NO S=Ø12,7mm	Spare parts		
45°	29	8	52	10	658.047.11		658.045.11				
22°	25	11	65	10	659.024.11	659.023.11	659.022.11		790.120.00	990.075.00	
30°	28	10	66	10	659.032.11	659.031.11	659.030.11		790.120.00	990.075.00	791.006.00
45°	29	8	60	10	659.047.11	659.046.11	659.045.11		790.120.00	990.075.00	791.022.00
45°	29	8	68	10				659.646.11	790.120.00	990.075.00	791.022.00

Spare parts: **990.400.00** Ø3.2/Ø7mm shield for M3 screw
990.051.00 M3x6mm TCEI screw
991.062.00 2,5mm hex key
991.061.00 T15 TORX® key

Chamfer Bits

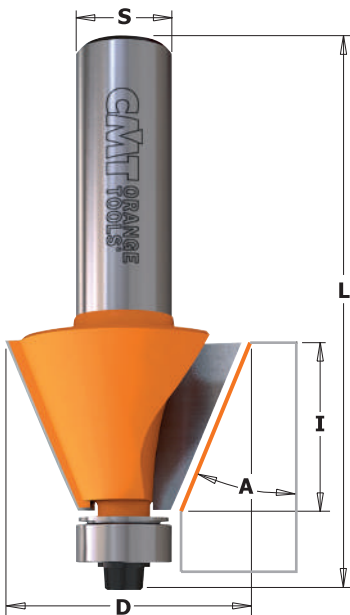

7/8/936 - 8/957

CMT chamfer bits can cut clean, accurate bevels and chamfers and are great for edge work or for making perfectly aligned multi-sided containers, boxes and other decorative projects. See illustration below for examples. Can be used for working larger scale projects such as beams and columns with excellent results.

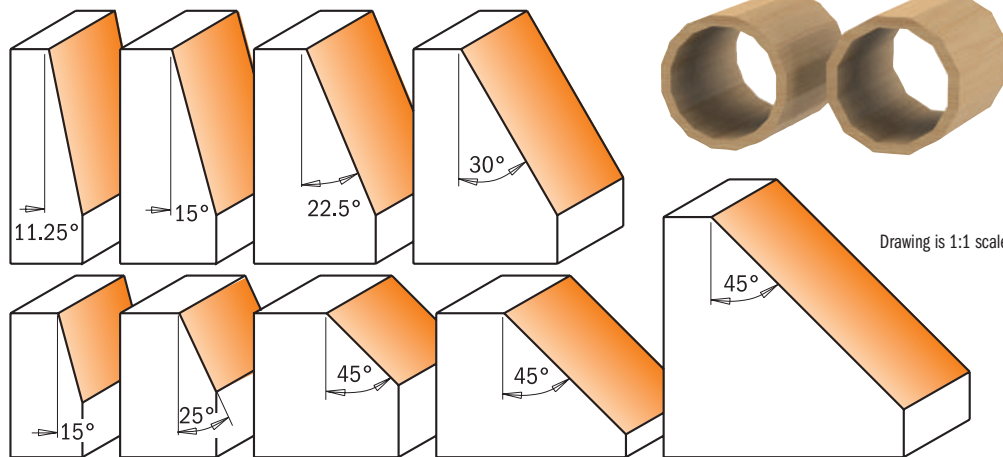
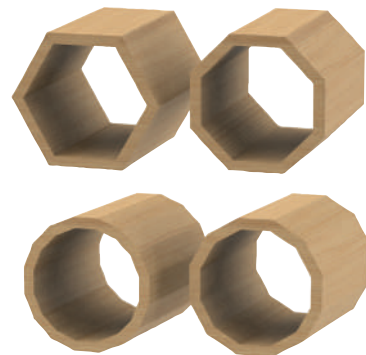

Drawing is 1:1 scale

A	D mm	I mm	L mm		ORDER NO. S=Ø6mm	ORDER NO. S=Ø6,35mm	ORDER NO. S=Ø8mm	ORDER NO. S=Ø12mm	ORDER NO. S=Ø12,7mm
15°	19	11,5	54,9	10	736.130.11	836.130.11	936.130.11		
25°	22,2	10	54,9	10	736.190.11	836.190.11	936.190.11		
45°	31,7	9,5	53	10	736.280.11	836.280.11	936.280.11		
45°	45	18	60,2	10	736.420.11	836.420.11	936.420.11		
45°	45	18	66,5	10				936.920.11	836.920.11
45°	65	26	76,7	5				936.950.11	836.950.11
11,25°	21,5	22	71,1	10				957.504.11	857.504.11
15°	24,5	22	71,1	10				957.503.11	857.503.11
22,5°	31	22	71,1	10				957.502.11	857.502.11
30°	38,5	22	71,1	10				957.501.11	857.501.11

Spare parts			
990.423.00	791.003.00	990.058.00	991.057.00
990.423.00	791.003.00	990.058.00	991.057.00
990.423.00	791.003.00	990.058.00	991.057.00
990.423.00	791.003.00	990.058.00	991.057.00
990.423.00	791.003.00	990.058.00	991.057.00
990.423.00	791.003.00	990.058.00	991.057.00
990.423.00	791.003.00	990.058.00	991.057.00
990.423.00	791.003.00	990.058.00	991.057.00
990.423.00	791.003.00	990.058.00	991.057.00
990.423.00	791.003.00	990.058.00	991.057.00
990.423.00	791.003.00	990.058.00	991.057.00

SHOP TIPS: After resharpening, replace bearing 791.003.11 (Ø12,7mm) with undersized bearing **791.063.00** (Ø12,5mm)

Chamfer Set



836

This set includes 5 anti-kickback carbide-tipped bits to make angled cuts and polygonal projects easier and more accurate in the most popular angles.

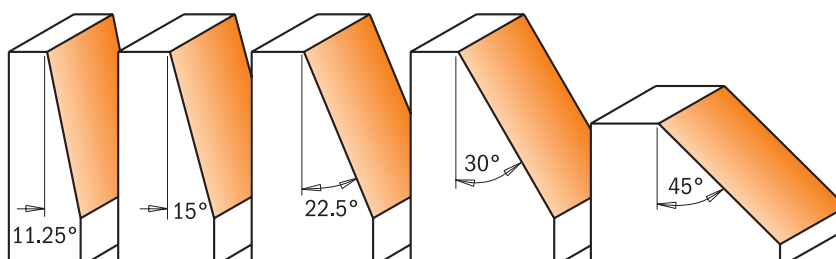

Drawing is 1:1 scale

DESCRIPTION		ORDER NO. S=Ø12,7mm
Chamfer Set	5	836.501.11

Round Nose Bits



7/8/914B

7/8/914



Personalize your doors, drawer fronts, panels or any surface with your own signature motif. CMT round nose bits in solid carbide featuring carbide tipped flutes let you create delicate and decorative accents in any wood or wood derivative.

SHOP TIPS: more than one pass is recommended when making cove edges. To prevent splintering, begin with a shallow initial pass and deepen gradually. Never use pieces shorter than 600mm.

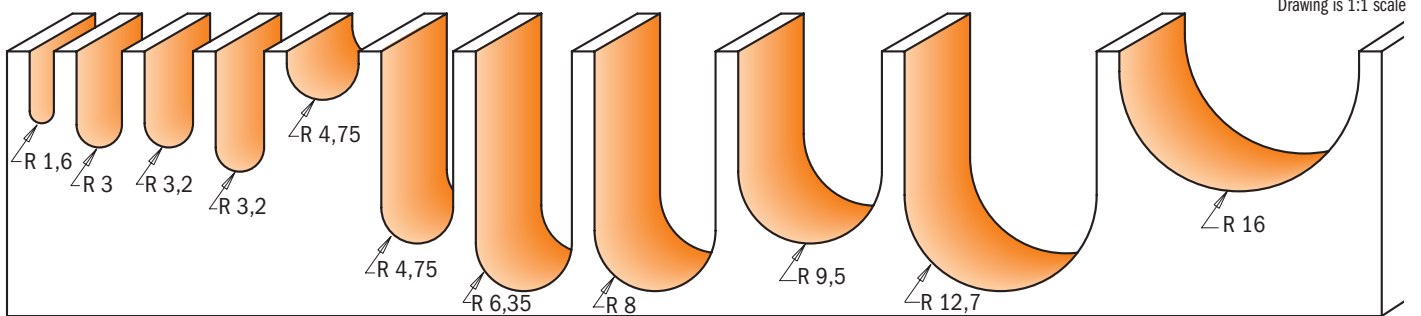

R mm	D mm	I mm	L mm		ORDER NO. S=Ø6mm	ORDER NO. S=Ø6,35mm	ORDER NO. S=Ø8mm	ORDER NO. S=Ø12mm	ORDER NO. S=Ø12,7mm
• 1,6	3,2	9,5	50,8	10	714.032.11	814.032.11	914.032.11		
• 1,6	3,2	12,7	50,8	10		199.001.11			
• 3	6	12,7	50,8	10	714.060.11		914.060.11		
• 3	6	27	70	10	199.060.11				
• 3,2	6,4	12,7	50,8	10		814.064.11			
• 3,2	6,4	25,4	63,5	10		199.008.11			
• 3,2	6,4	15,9	63,5	10					814.564.11
• 4	8	32	80	10			199.081.11		
4,75	9,5	6,4	50,8	10	714.095.11	814.095.11	914.095.11		
4,75	9,5	25,4	66,7	10					814.595.11
• 6	12	35	80	10				199.120.11	
6,35	12,7	9,5	50,8	10	714.127.11	814.127.11	914.127.11		
6,35	12,7	31,7	73	10				914.627.11	814.627.11
• 6,35	12,7	31,7	76,2	10					199.505.11
8	15,8	9,5	50,8	10	714.160.11	814.160.11	914.160.11		
8	15,8	31,7	73	10					814.660.11
9,5	19	11,3	50,8	10	714.190.11	814.190.11	914.190.11		
9,5	19	25	63,5	10			914.191.11		
9,5	19	31,7	73	10				914.690.11	814.690.11
11	22	25,4	63,5	10			914.221.11		
12,7	25,4	16	58,8	10			914.254.11		
12,7	25,4	31,7	73	10				914.754.11	814.754.11
16	31,7	18,5	58,8	10				914.817.11	814.817.11
19,05	38,1	31,7	69,8	10				914.880.11	814.880.11
25,4	50,8	31,7	69,8	10				914.990.11	814.990.11
With top bearing									
6,35	12,7	9,5	50,8	10		814.127.11B			
8	15,8	9,5	50,8	10		814.160.11B			
8	15,8	9,5	50,8	10			914.160.11B		
9,5	19	11,3	50,8	10	714.190.11B				
9,5	19	11,3	50,8	10		814.190.11B			
9,5	19	31,7	73	10					814.690.11B



Spare parts	
791.010.00	541.001.00
791.009.00	541.001.00
791.025.00	541.004.00
791.007.00	541.003.00
791.004.00	541.001.00
791.011.00	541.002.00

Spare parts: 990.005.00 M3x3mm TSEI screw
991.056.00 1,5mm hex key

• HWM

Ball End Bit

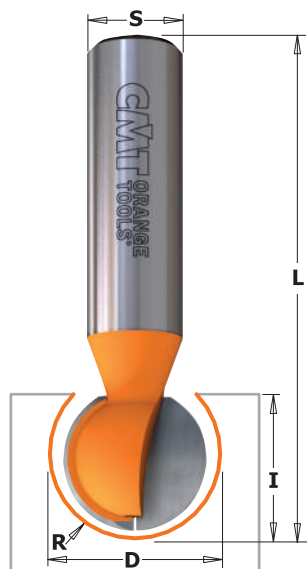

8/968

Cut channels for pipes or cables in one single pass using CMT's ball end bits. Reduce the stress on the bits by cutting a first groove with a straight bit.

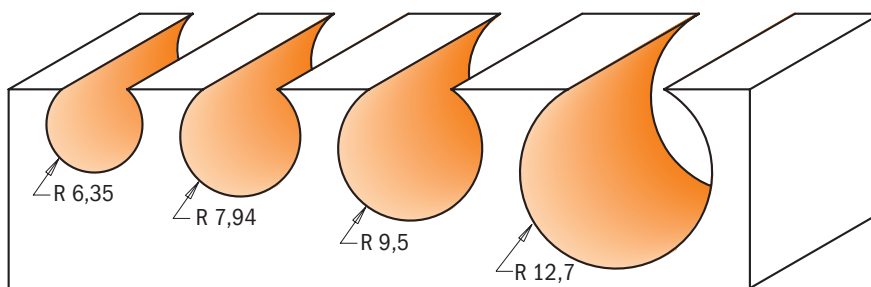

Drawing is 1:1 scale

R mm	D mm	I mm	L mm		ORDER NO. S=Ø8mm	ORDER NO. S=Ø12mm	ORDER NO. S=Ø12,7mm
6,35	12,7	11	57,15	10	968.127.11		868.627.11
7,94	15,88	14,2	60,3	10	968.158.11		868.658.11
9,52	19,05	17,4	63,5	10	968.190.11		868.690.11
12,7	25,4	23,5	70	10		968.754.11	868.754.11

Round Nose Set



814

Each of these sets include 3 of the most widely used CMT Round Nose bits. These solid carbide or carbide tipped bits are perfect for sign making, engraving, or adding flutes and veins to doors or drawer fronts. Available in 6,35mm and 12,7mm shanks.

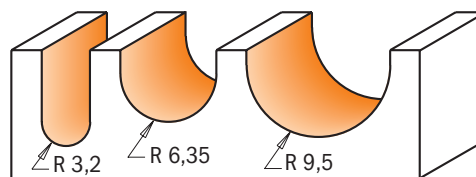

814.001.11

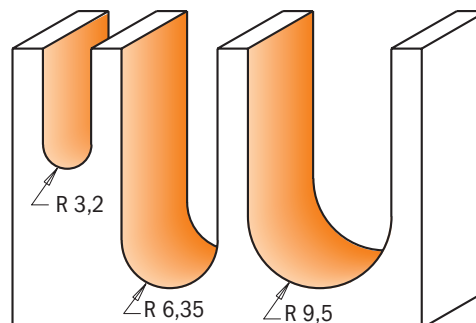

814.501.11

Drawing is 1:1 scale

DESCRIPTION		ORDER NO. S=Ø6,35mm	ORDER NO. S=Ø12,7mm
Round Nose Set	5	814.001.11	814.501.11

Cove Bits

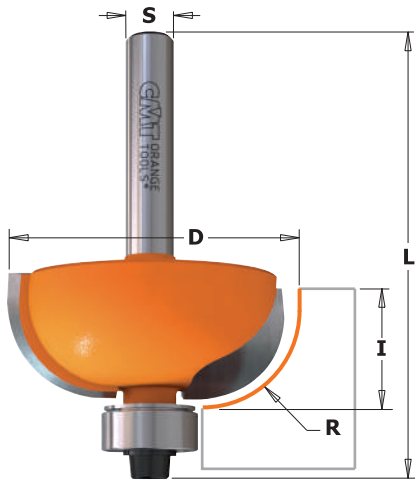

7/8/937

Make simple or elegant furniture, doors and drawer fronts by adding a final touch with CMT cove bits. Tips: rounded edges provide a very refined and elegant look.

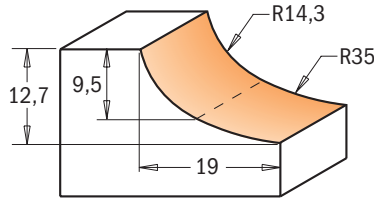

8/937.955.11



CMT's carbide tipped cove bits are a perfect match for the roundover bits on the next page. That means they're the ideal way to produce rule joints for your drop leaf tables.

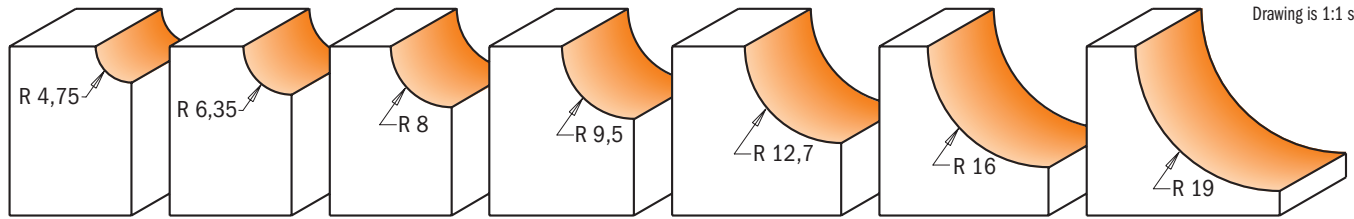

Drawing is 1:1 scale

R mm	D mm	I mm	L mm		ORDER NO. S=Ø6mm	ORDER NO. S=Ø6,35mm	ORDER NO. S=Ø8mm	ORDER NO. S=Ø12mm	ORDER NO. S=Ø12,7mm	Spare parts			
4,75	22,2	12,7	54,9	10	737.190.11	837.190.11	937.190.11						
4,75	22,2	12,7	61,2	10				937.690.11	837.690.11	990.423.00	791.003.00	990.058.00	991.057.00
6,35	25,4	12,7	54,9	10	737.222.11	837.222.11	937.222.11			990.423.00	791.003.00	990.058.00	991.057.00
6,35	25,4	12,7	61,2	10				937.722.11	837.722.11	990.423.00	791.003.00	990.058.00	991.057.00
8	28,7	12,7	54,2	10	737.254.11	837.254.11	937.254.11			990.423.00	791.003.00	990.058.00	991.057.00
8	28,7	12,7	60,5	10				937.754.11	837.754.11	990.423.00	791.003.00	990.058.00	991.057.00
9,5	31,7	12,7	54,2	10	737.286.11	837.286.11	937.286.11			990.423.00	791.003.00	990.058.00	991.057.00
9,5	31,7	12,7	60,5	10				937.786.11	837.786.11	990.423.00	791.003.00	990.058.00	991.057.00
12,7	38,1	15,5	57,7	10	737.350.11	837.350.11	937.350.11			990.423.00	791.003.00	990.058.00	991.057.00
12,7	38,1	15,5	64	10				937.850.11	837.850.11	990.423.00	791.003.00	990.058.00	991.057.00
16	44,5	18,5	67	10				937.950.11	837.950.11	990.423.00	791.003.00	990.058.00	991.057.00
19	50,8	22,2	70,7	10				937.951.11	837.951.11	990.423.00	791.003.00	990.058.00	991.057.00
14,3-35	50,8	12,7	61,2	10				937.955.11	837.955.11	990.423.00	791.003.00	990.058.00	991.057.00

Cove Bit Set



837

See simple furniture, doors and drawer fronts transform into elegant pieces by giving them a final touch with a CMT Cove Bit. Available with 6,35mm-12,7mm shank and cove radii from 6,35mm - 9,5mm - 12,7mm.

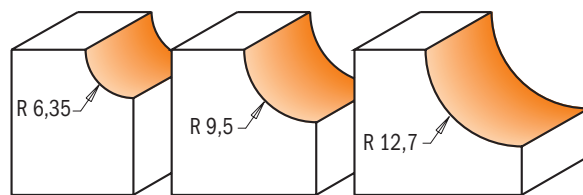

Drawing is 1:1 scale

DESCRIPTION		ORDER NO. S=Ø6,35mm	ORDER NO. S=Ø12,7mm
Cove Bit Set	5	837.001.11	837.501.11

Cavetto Edge Mould Bits



7/8/963 - 7/8/964

The cavetto bit cuts beautiful, traditional profiles, but you may also use just a portion of the bit to cut a more simple and cleaner cove edge.

SAFETY TIPS: poor assembly may lead to unscrewing and loss of the bearing during operation.

SHOP TIPS: after resharpening, replace bearing as follow:
 791.002.00 (Ø9,5mm) with undersized bearing **791.062.00** (Ø9,3mm)
 791.003.00 (Ø12,7mm) with undersized bearing **791.063.00** (Ø12,5mm)

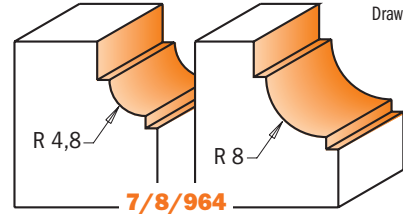
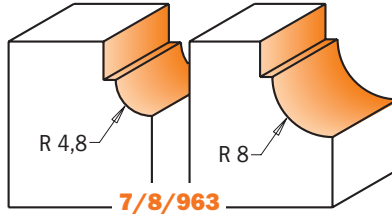
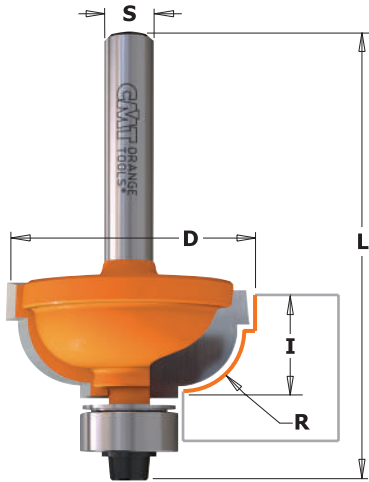

Drawing is 1:1 scale

R mm	D mm	I mm	L mm		ORDER NO. S=Ø6mm	ORDER NO. S=Ø6,35mm	ORDER NO. S=Ø8mm	ORDER NO. S=Ø12mm	ORDER NO. S=Ø12,7mm
4,8	25,4	11,5	54,6	10	763.048.11	863.048.11	963.048.11		
4,8	25,4	11,5	60,9	10				963.548.11	863.548.11
8	31,7	14,3	56,9	10	763.080.11	863.080.11	963.080.11		
8	31,7	14,3	63	10				963.580.11	863.580.11
4,8	25,4	11,5	52,8	10	764.048.11	864.048.11	964.048.11		
4,8	25,4	11,5	59,1	10				964.548.11	864.548.11
8	31,7	14,3	55,1	10	764.080.11	864.080.11	964.080.11		
8	31,7	14,3	61	10				964.580.11	864.580.11

Spare parts

990.423.00	791.003.00	990.058.00	991.057.00
990.423.00	791.003.00	990.058.00	991.057.00
990.423.00	791.003.00	990.058.00	991.057.00
990.423.00	791.003.00	990.058.00	991.057.00
990.422.00	791.002.00	990.058.00	991.057.00
990.422.00	791.002.00	990.058.00	991.057.00
990.422.00	791.002.00	990.058.00	991.057.00
990.422.00	791.002.00	990.058.00	991.057.00

Ovolo Bits

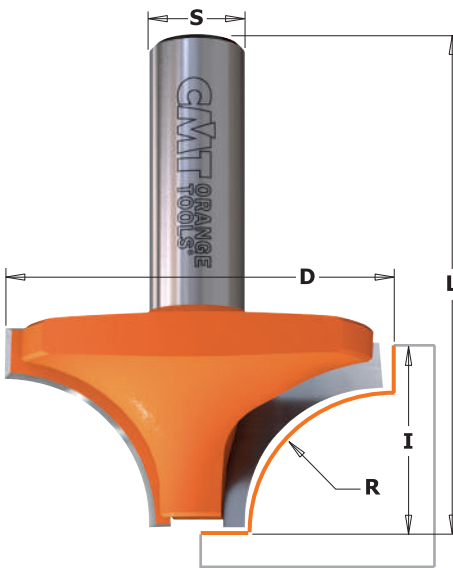

7/8/927



The perfect bit for furniture makers, the CMT ovolo allows you to make beautiful beadwork, edgework and veins as well as a wide variety of single and double bead profiles and roundovers.

SAFETY TIPS: pay particular attention to never rush the job when using a large profile bit. Mill pieces with a fence mounted on the work table to ensure maximum protection.

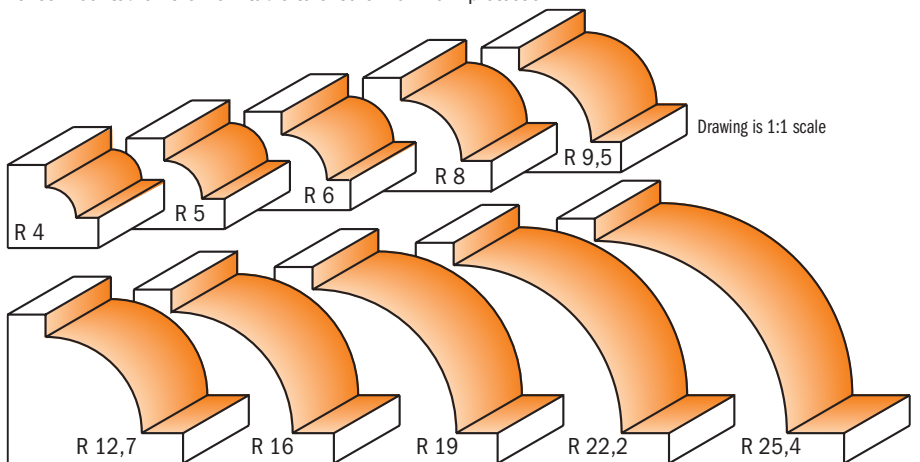

Drawing is 1:1 scale

R mm	D mm	I mm	L mm		ORDER NO. S=Ø6mm	ORDER NO. S=Ø6,35mm	ORDER NO. S=Ø8mm	ORDER NO. S=Ø12mm	ORDER NO. S=Ø12,7mm
4	19	12	43,8	10	727.040.11		927.040.11		
5	21	12	43,8	10	727.050.11	827.050.11	927.050.11		
6	23	12	43,8	10	727.060.11	827.060.11	927.060.11		
6	23	12	50,1	10					827.560.11
8	28,7	12,7	44,5	10	727.080.11		927.080.11		
9,5	31,7	15,8	47,6	10	727.095.11	827.095.11	927.095.11		
9,5	31,7	15,8	54	10				927.595.11	827.595.11
12,7	38,1	19	50,8	10		827.127.11			
12,7	38,1	19	57,1	10				927.627.11	827.627.11
16	44,5	22,2	60,3	10				927.660.11	827.660.11
19	50,8	25,4	63,5	10				927.690.11	827.690.11
22,2	57,1	28,5	66,6	5				927.722.11	827.722.11
25,4	63,5	33,3	71,4	5				927.754.11	827.754.11

7/8/939



If you want to create a delicate inset at the base of the cut of a roundover profile, simply switch the bearing normally used for making profiles 7/8/938 (listed on the following page) to the undersized one listed below (791.002.00).

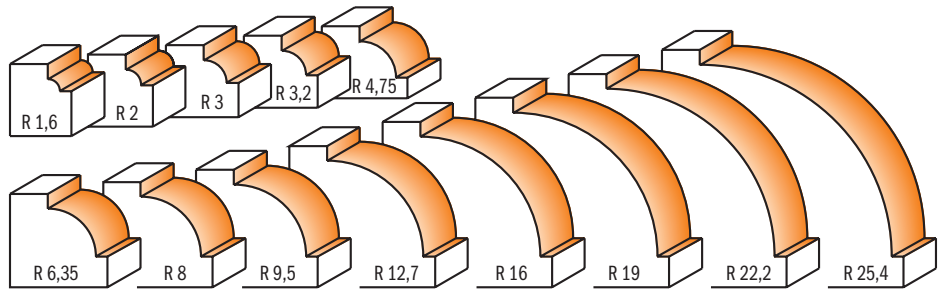
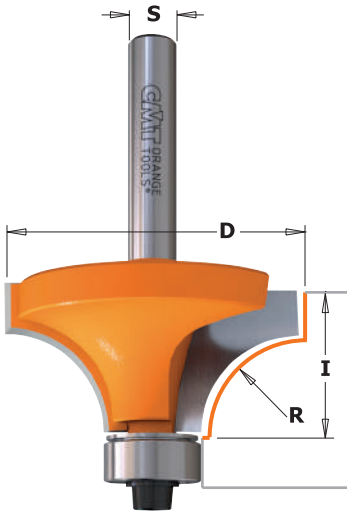

Drawing is 1:1 scale

R mm	D mm	I mm		ORDER NO. S=Ø6mm	ORDER NO. S=Ø6,35mm	ORDER NO. S=Ø8mm	ORDER NO. S=Ø12mm	ORDER NO. S=Ø12,7mm	Spare parts							
1,6	15,9	12,7	10	739.160.11	839.160.11	939.160.11						990.422.00	791.002.00	990.058.00	991.057.00	
2	16,7	12,7	10			939.167.11			990.422.00	791.002.00	990.058.00	991.057.00	990.422.00	791.002.00	990.058.00	991.057.00
3	18,7	12,7	10			939.187.11			990.422.00	791.002.00	990.058.00	991.057.00	990.422.00	791.002.00	990.058.00	991.057.00
3,2	19,1	12,7	10	739.190.11	839.190.11	939.190.11			990.422.00	791.002.00	990.058.00	991.057.00	990.422.00	791.002.00	990.058.00	991.057.00
4,75	22,2	12,7	10	739.222.11	839.222.11	939.222.11			990.422.00	791.002.00	990.058.00	991.057.00	990.422.00	791.002.00	990.058.00	991.057.00
6,35	25,4	12,7	10	739.254.11	839.254.11	939.254.11	939.754.11	839.754.11	990.422.00	791.002.00	990.058.00	991.057.00	990.422.00	791.002.00	990.058.00	991.057.00
8	28,6	12,7	10	739.285.11	839.285.11	939.285.11			990.422.00	791.002.00	990.058.00	991.057.00	990.422.00	791.002.00	990.058.00	991.057.00
9,5	31,7	16	10	739.317.11	839.317.11	939.317.11	939.817.11	839.817.11	990.422.00	791.002.00	990.058.00	991.057.00	990.422.00	791.002.00	990.058.00	991.057.00
12,7	38,1	19	10	739.380.11	839.380.11	939.380.11	939.880.11	839.880.11	990.422.00	791.002.00	990.058.00	991.057.00	990.422.00	791.002.00	990.058.00	991.057.00
16	44,5	22	10		839.445.11	939.445.11	939.945.11	839.945.11	990.422.00	791.002.00	990.058.00	991.057.00	990.422.00	791.002.00	990.058.00	991.057.00
19	50,8	25,4	10				939.990.11	839.990.11	990.422.00	791.002.00	990.058.00	991.057.00	990.422.00	791.002.00	990.058.00	991.057.00
22,2	57,1	28,5	5				939.991.11	839.991.11	990.422.00	791.002.00	990.058.00	991.057.00	990.422.00	791.002.00	990.058.00	991.057.00
25,4	63,5	33,3	5				939.992.11*	839.992.11*	990.422.00	791.002.00	990.058.00	991.057.00	990.422.00	791.002.00	990.058.00	991.057.00

*For use on router tables only.

Roundover Bits with Insert Knives

661.11

Roundover bits with two replaceable knives fixed by special TORX® screws. The blades are profiled on 2 sides and increase the efficiency of your work with laminates and chipboard, as well as hard and soft woods. For use on portable routers.

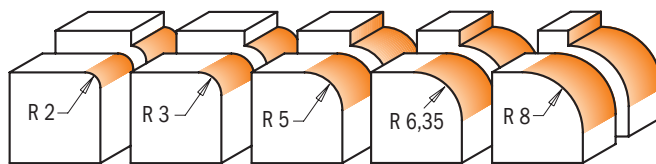

Drawing is 1:1 scale



SAFETY TIPS:

The **TW-006** Torque Screwdriver is recommended for the proper fastening of screws (see page 406).

CORRECT KNIFE POSITIONING

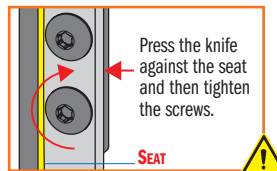

Optional

- R=1mm 790.010.04
- R=1,5mm 790.015.04
- R=2mm 790.020.04
- R=3mm 790.030.04

R mm	D mm	I mm	L mm		ORDER NO. S=Ø6,35mm	ORDER NO. S=Ø8mm	ORDER NO S=Ø12,7mm	Spare parts							
2	27		57,5	10	661.021.41	661.020.41						790.020.04	990.078.00	991.061.00	791.003.00
3	27		57,5	10	661.031.41	661.030.41		790.030.04	990.078.00	991.061.00	791.003.00	790.050.00	990.076.00	991.061.00	791.007.00
5	28,8	19,5	64	10	661.051.11	661.050.11		790.064.00	990.076.00	991.061.00	791.006.00	790.080.00	990.075.00	991.061.00	791.006.00
6,35	28,5	24	67	10	661.064.11	661.063.11		790.080.00	990.075.00	991.061.00	791.006.00	790.080.00	990.075.00	991.061.00	791.006.00
8	31,8	24	67	10		661.080.11									
8	31,8	24	77	10			661.581.11								

- Spare parts** 990.400.00 M3 shield 990.410.00 M4 shield 990.423.00 Shield for 12,7mm bearing
 990.051.00 M3x6mm TCEI screw 990.052.00 M4x6mm TCEI screw 990.058.00 1/8"x3/8"x1/2" TCEI screw
 991.062.00 2,5mm hex key 991.067.00 3mm hex key 991.057.00 3/32" hex key

DP - Corner Rounding Router Bits for composites and laminates

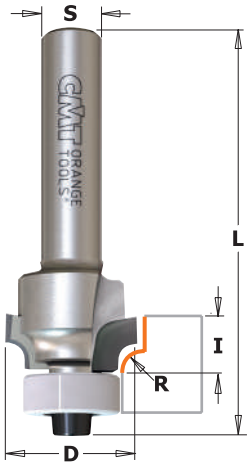

938 XTREME

These new super duty DP (polycrystalline diamond) bits represent the ultimate in the extensive line of CMT rounding over bits. These bits save you both time and money, as they last 40 times longer than conventional bits. Work a wide variety of tough, abrasive materials including composites, particleboard, MDF (both raw or with melamine), veneer and hardwoods.

Excellent for Corner Rounding:

- Aluminum
- Aluminum Composites
- Aluminum Composite Material (ACM)
- Composites
- Composite Panels
- Custom Composite Materials
- Fiberglass
- Fiberglass PCB Board
- Fiberglass Reinforced Composites
- Fiber-Reinforced Urethane
- Fiber-Reinforced Structural Foam Floors
- Hard and Soft Wood
- Lightweight Composites
- MDF
- Plastic

Benefits of Diamond Technology

- Harder cutting edge provides higher resistance to wear
- Cut thousands of meters more than carbide without changing tool, saving setup time
- Optimized machine tool efficiency
- Quality of finish is often significantly improved

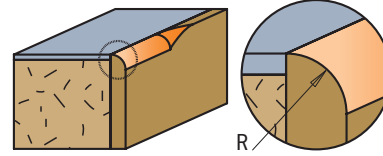

R mm	D mm	I mm		ORDER NO. S=Ø8mm
2	16,7	8	10	938.167.61
3	18,7	8	10	938.187.61

Spare parts

990.422.00	791.044.00	990.058.00	991.057.00
990.422.00	791.044.00	990.058.00	991.057.00

791.044.00 DELRIN® bearing

Decorative Ogee Bits

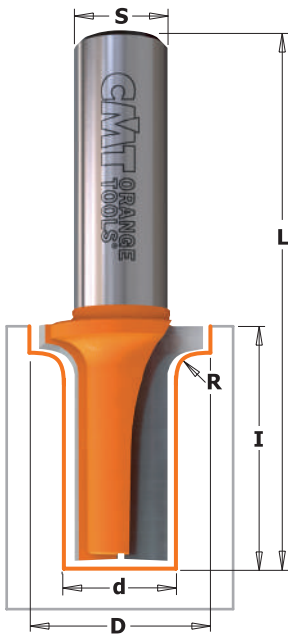

8/965.905



8/965.903
8/965.904

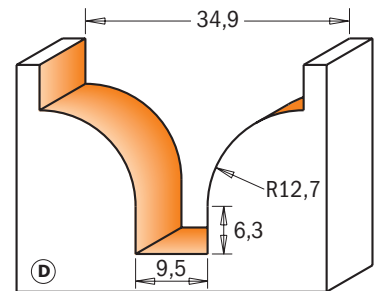
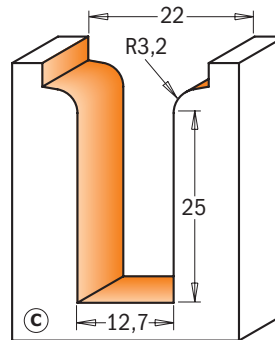
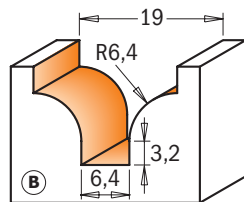

Drawing is 1:1 scale

8/965.9



Enhance your doors and drawer fronts and leave your visitors amazed! The cutting edges on these ogee bits are carbide-tipped for effective, smooth and eye-catching work.

D mm	d mm	R mm	I mm	L mm	PROFILE		ORDER NO. S=Ø12mm	ORDER NO. S=Ø12,7mm
19	6,4	6,4	13	51	B	10	965.903.11	865.903.11
22	12,7	3,2	31,7	69,8	C	10	965.905.11	865.905.11
34,9	9,5	12,7	25	65,5	D	10	965.904.11	865.904.11

Decorative Beading Bits

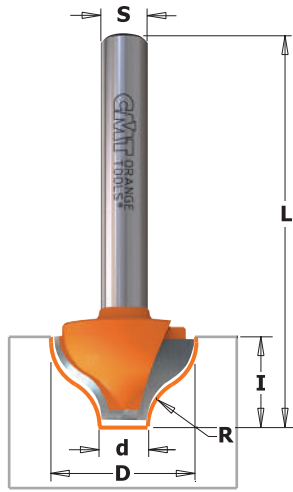

7/8/965

This new CMT bit produces a classic single or double-edged bead. Ideal for creating a marked decorative effect on panel, door and drawer work.

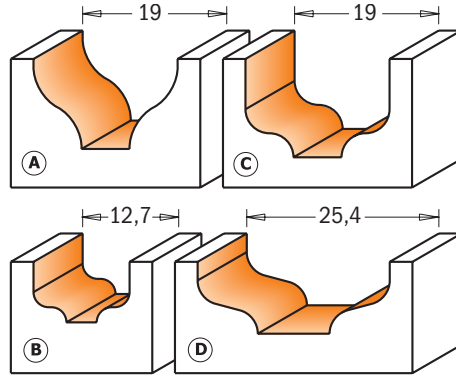

Drawing is 1:1 scale

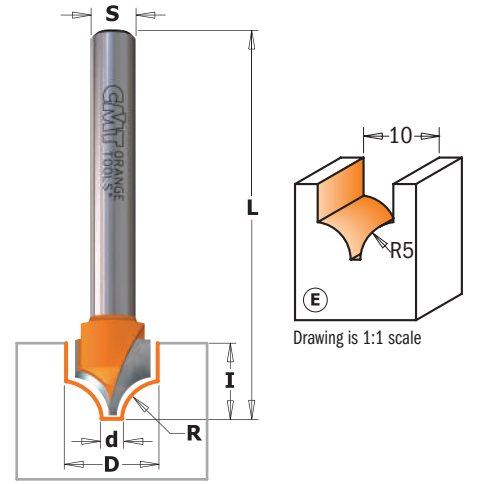

Drawing is 1:1 scale

D mm	d mm	R mm	I mm	L mm	PROFILE		ORDER NO. S=Ø6mm	ORDER NO. S=Ø6,35mm	ORDER NO. S=Ø8mm	ORDER NO. S=Ø12mm	ORDER NO. S=Ø12,7mm
19	6,35	6,4	11	50,8	A	10	765.001.11	865.001.11	965.001.11	965.501.11	865.501.11
12,7	4	2	8	51	B	10		865.002.11	965.002.11		
19	6,35	3,2	13	68	C	10				965.503.11	865.503.11
25,4	9,5	3,2	9,5	49	D	10				965.504.11	865.504.11
10	1,3	5	10	50	E	10	765.402.11	865.402.11	965.402.11		

Classical Bead Bits

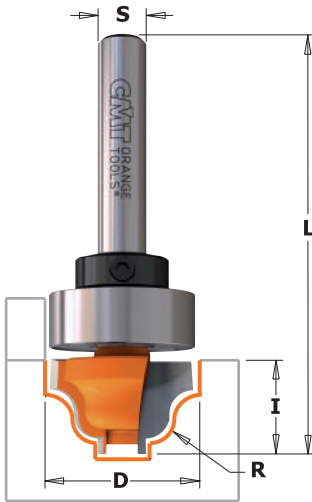

7/8/965B

This bit equipped with a bearing fixed on the shank gives you even more decorative possibilities such as inlays and groove work on furniture panels, vitrines, and drawer fronts. A wide flat bottom cut and positioning just above the wood surface, lets you see the results immediately.

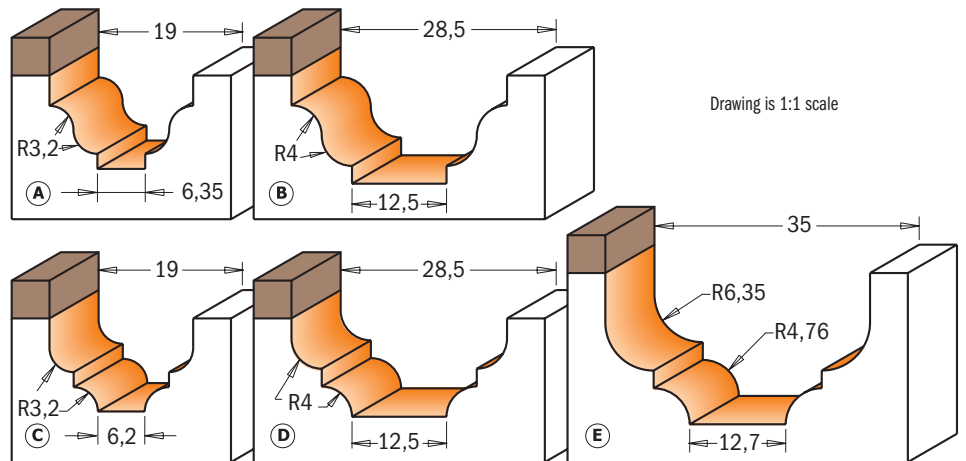

Drawing is 1:1 scale

D mm	R mm	I mm	L mm	PROFILE		ORDER NO S=Ø6mm	ORDER NO S=Ø6,35mm	ORDER NO S=Ø8mm	ORDER NO S=Ø12mm	ORDER NO S=Ø12,7mm	Spare parts		
19	3,2	12,3	54	A	10	765.201.11B							
19	3,2	12,3	54	A	10		865.201.11B				791.007.00	541.003.00	991.056.00
28,6	4	14,3	58,8	B	10			965.202.11B			791.004.00	541.001.00	991.056.00
28,6	4	14,3	58,8	B	10				965.702.11B		791.027.00	541.002.00	991.056.00
28,6	4	14,3	58,8	B	10					865.702.11B	791.027.00	541.005.00	991.056.00
19	3,2	12,3	54	C	10	765.301.11B					791.027.00	541.002.00	991.056.00
19	3,2	12,3	54	C	10		865.301.11B				791.007.00	541.003.00	991.056.00
28,6	4	13,3	58	D	10			965.302.11B		865.802.11B	791.004.00	541.001.00	991.056.00
28,6	4	13,3	58	D	10				965.802.11B		791.027.00	541.002.00	991.056.00
34,9	4,76 - 6,35	18,5	66,1	E	10			965.303.11B			791.027.00	541.005.00	991.056.00
34,9	4,76 - 6,35	18,5	66,1	E	10				865.803.11B		791.031.00	541.004.00	991.056.00
											791.029.00	541.002.00	991.056.00

Spare parts: 990.005.00 M3x3mm TSEI screw

Plunge Ogee Bits



7/8/948B

You will never run out of ideas with this creative bit. Add a classic touch to any edge or highlight door fronts and panels with decorative layered effects.

SHOP TIPS: for even more options, try the CMT plunge ogee with bearing for precision profiling. The bearing guarantees excellent decorative edgework.

7/8/948

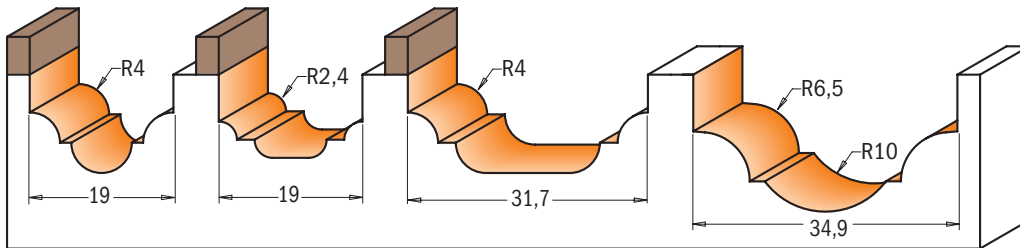
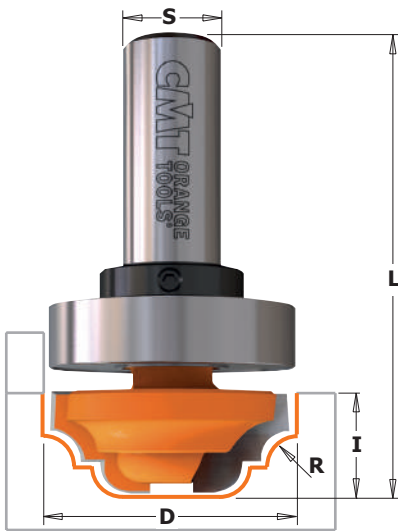

Drawing is 1:1 scale

D mm	R mm	I mm	L mm		ORDER NO S=Ø6mm	ORDER NO S=Ø6,35mm	ORDER NO S=Ø8mm	ORDER NO S=Ø12mm	ORDER NO S=Ø12,7mm
19	4	13	51,1	10	748.190.11	848.190.11	948.190.11		
19	2,4	12	53	10	748.191.11	848.191.11	948.191.11		
31,7	4	13	58	10			948.317.11	948.817.11	848.817.11
34,9	6,5-10	18	68	10				948.850.11	848.850.11
With top bearing									
19	4	13	51,1	10	748.190.11B				
19	4	13	51,1	10		848.190.11B			
19	2,4	12	53	10	748.191.11B				
19	2,4	12	53	10		848.191.11B			
31,7	4	13	58	10			948.317.11B		
31,7	4	13	58	10				948.817.11B	
31,7	4	13	58	10					848.817.11B

Spare parts

791.007.00	541.003.00	991.056.00
791.004.00	541.001.00	991.056.00
791.007.00	541.003.00	991.056.00
791.004.00	541.001.00	991.056.00
791.015.00	541.002.00	991.056.00
791.015.00	541.005.00	991.056.00
791.015.00	541.002.00	991.056.00

Spare parts: 990.005.00 M3x3mm TSEI screw

Decorative Ogee Bits

7/8/965.1

This new CMT bit produces a classic single or double edged bead. Ideal for creating a marked decorative effect on panel, door and drawer work.

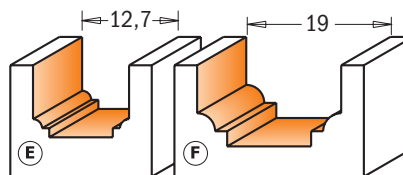
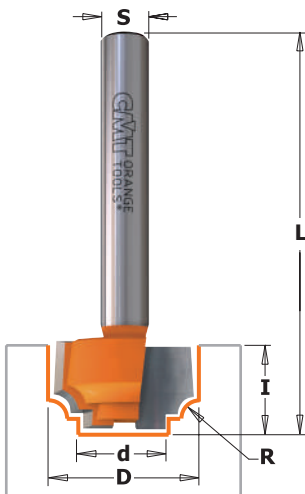

Drawing is 1:1 scale

D mm	d mm	R mm	I mm	L mm	PROFILE		ORDER NO. S=Ø6mm	ORDER NO. S=Ø6,35mm	ORDER NO. S=Ø8mm
12,7	8,4	1,2	12,7	50,8	E	10	765.101.11	865.101.11	965.101.11
19	11,1	2,4	11	50,8	F	10	765.102.11	865.102.11	965.102.11

Roman Ogee Bits

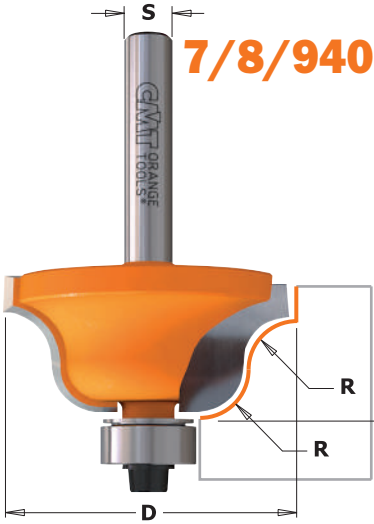

7/8/940

The roman ogee may be the most popular edge treatment in woodworking, and it is certainly one of the most beautiful and varied in classic design.

SHOP TIPS: given the complexity of this kind of machining, for best results, multiple passes are recommended.

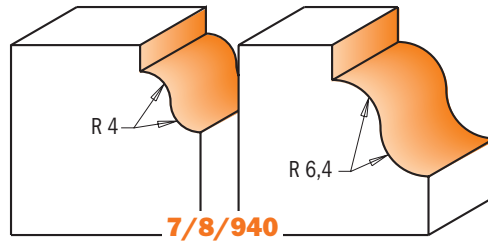

7/8/940

Drawing is 1:1 scale

7/8/941

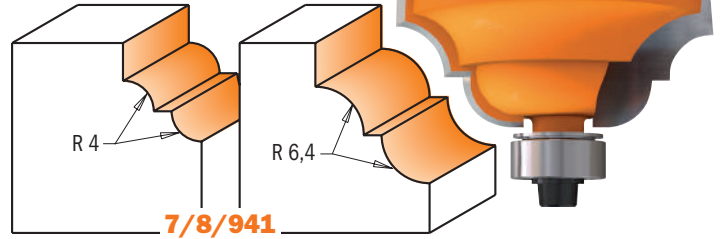

7/8/941

An extra horizontal cutting edge provides refined style and elegance to these traditional profiles **7/8/940**.

SHOP TIPS: for best results, multiple passes are recommended.

R mm	D mm	I mm		ORDER NO. S=Ø6mm	ORDER NO. S=Ø6,35mm	ORDER NO. S=Ø8mm	ORDER NO. S=Ø12mm	ORDER NO. S=Ø12,7mm
4	28,7	11,5	10	740.270.11	840.270.11	940.270.11	940.770.11	840.770.11
6,4	38,1	17,3	10	740.350.11	840.350.11	940.350.11	940.850.11	840.850.11
4	33,4	13	10	741.285.11	841.285.11	941.285.11	941.785.11	841.785.11
6,4	42,8	18,5	10	741.380.11	841.380.11	941.380.11	941.880.11	841.880.11

Spare parts

	990.423.00	791.003.00	990.058.00	991.057.00
	990.423.00	791.003.00	990.058.00	991.057.00
	990.423.00	791.003.00	990.058.00	991.057.00
	990.423.00	791.003.00	990.058.00	991.057.00

SHOP TIPS: after resharpening, replace bearing 791.003.11 (Ø12,7mm) with undersized bearing **791.063.00** (Ø12,5mm)

Classical Ogee Bits

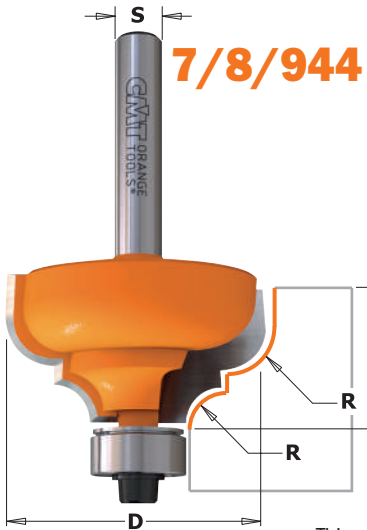

7/8/944

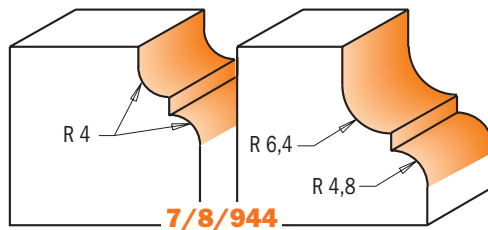

7/8/944

Drawing is 1:1 scale

7/8/945

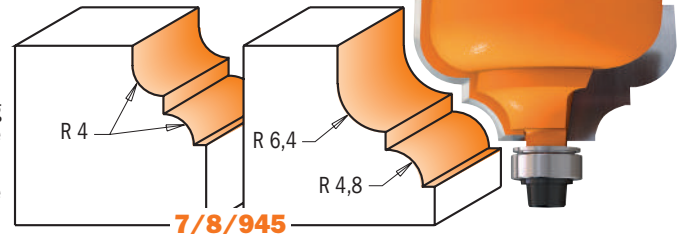

7/8/945

This profile includes a horizontal bead along the bottom of the profile adding a decorative detail to the traditional ogee design.

SHOP TIPS: for best results, multiple passes are recommended.

R mm	D mm	I mm		ORDER NO. S=Ø6mm	ORDER NO. S=Ø6,35mm	ORDER NO. S=Ø8mm	ORDER NO. S=Ø12mm	ORDER NO. S=Ø12,7mm
4	28,7	13	10	744.287.11	844.287.11	944.287.11	944.787.11	844.787.11
6,4-4,8	35	18,5	10	744.350.11	844.350.11	944.350.11	944.850.11	844.850.11
4	28,7	13	10	745.287.11	845.287.11	945.287.11	945.787.11	845.787.11
6,4-4,8	35	18,5	10	745.350.11	845.350.11	945.350.11	945.850.11	845.850.11

Spare parts

	990.423.00	791.003.00	990.058.00	991.057.00
	990.423.00	791.003.00	990.058.00	991.057.00
	990.422.00	791.002.00	990.058.00	991.057.00
	990.422.00	791.002.00	990.058.00	991.057.00

SHOP TIPS: after resharpening, replace bearing as follow:
791.002.00 (Ø9,5mm) with undersized bearing **791.062.00** (Ø9,3mm)
791.003.00 (Ø12,7mm) with undersized bearing **791.063.00** (Ø12,5mm)

Ogee with Fillet Bits



7/8/946

The new decorative possibilities with this bit are endless. Every bit is composed of the highest quality tungsten carbide and protected with our orange trademarked P.T.F.E. coating.

SHOP TIPS: this type of machining can be very challenging, for best results, multiple passes are recommended.

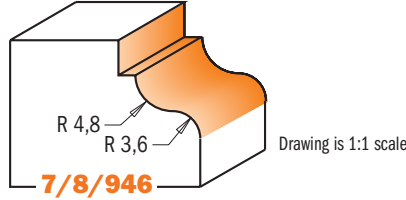

7/8/946

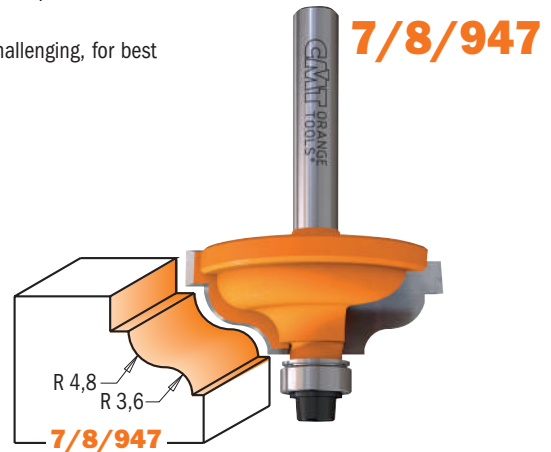

7/8/947

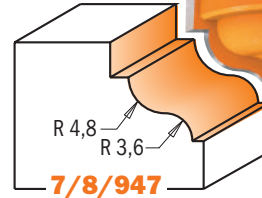

7/8/947

R mm	D mm	I mm		ORDER NO. S=Ø6mm	ORDER NO. S=Ø6,35mm	ORDER NO. S=Ø8mm	ORDER NO. S=Ø12mm	ORDER NO. S=Ø12,7mm
4,8-3,6	34,2	13	10	746.325.11	846.325.11	946.325.11	946.825.11	846.825.11
4,8-3,6	34,2	13	10	747.325.11	847.325.11	947.325.11	947.825.11	847.825.11

Spare parts

990.423.00	791.003.00	990.058.00	991.057.00
990.423.00	791.003.00	990.058.00	991.057.00

SHOP TIPS: after resharpening, replace bearing as follow:
791.002.00 (Ø9,5mm) with undersized bearing **791.062.00** (Ø9,3mm)
791.003.00 (Ø12,7mm) with undersized bearing **791.063.00** (Ø12,5mm)

Ogee Bits

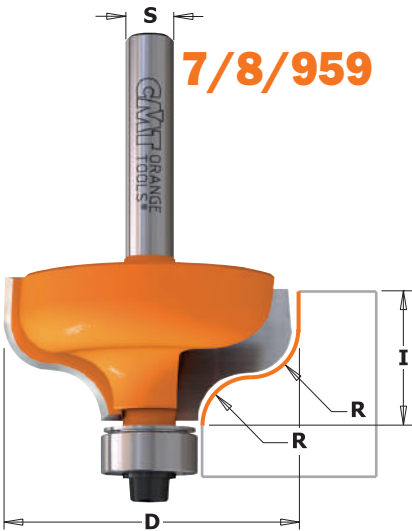

7/8/959

These profiles are the mirror image of the traditional roman ogee. They add sharp defining details to the edges of cabinets and furniture, before rolling into a smooth convex shape.

SHOP TIPS: this type of machining can be very challenging, for best results, multiple passes are recommended.

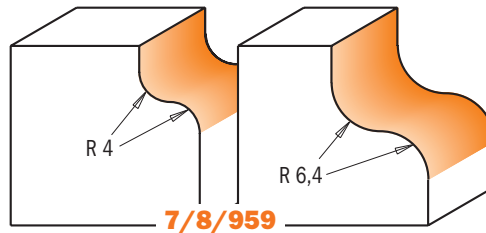

7/8/959

Drawing is 1:1 scale

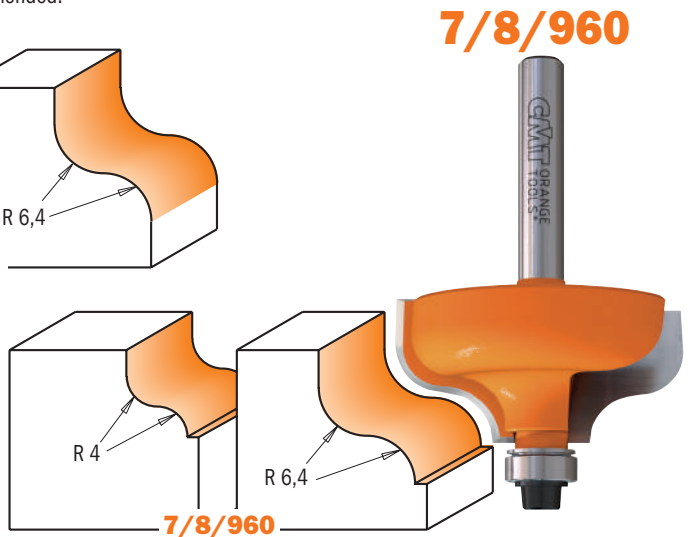

7/8/960

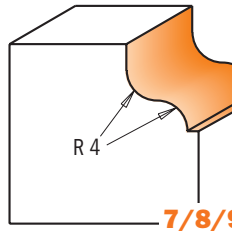

7/8/960

R mm	D mm	I mm		ORDER NO. S=Ø6mm	ORDER NO. S=Ø6,35mm	ORDER NO. S=Ø8mm	ORDER NO. S=Ø12mm	ORDER NO. S=Ø12,7mm
4	28,7	13	10	759.040.11	859.040.11	959.040.11	959.540.11	859.540.11
6,4	38,1	18	10	759.064.11	859.064.11	959.064.11	959.564.11	859.564.11
4	28,7	13	10	760.040.11	860.040.11	960.040.11	960.540.11	860.540.11
6,4	38,1	18	10	760.064.11	860.064.11	960.064.11	960.564.11	860.564.11

Spare parts

990.423.00	791.003.00	990.058.00	991.057.00
990.423.00	791.003.00	990.058.00	991.057.00
990.422.00	791.002.00	990.058.00	991.057.00
990.422.00	791.002.00	990.058.00	991.057.00

SHOP TIPS: after resharpening, replace bearing as follow:
791.002.00 (Ø9,5mm) with undersized bearing **791.062.00** (Ø9,3mm)
791.003.00 (Ø12,7mm) with undersized bearing **791.063.00** (Ø12,5mm)



8/900.623



These CMT bits are ideal for making attractive edgework! Create a double 4,76mm (3/16") roundover profile, a double 45° bevel or even a mixed profile on your wood panels easily and in a cost-effective way! Interchangeable shims are included to allow for different stock thicknesses according to the board. To be used on table-mounted routers. Do not use these bits with hand-held power tools.

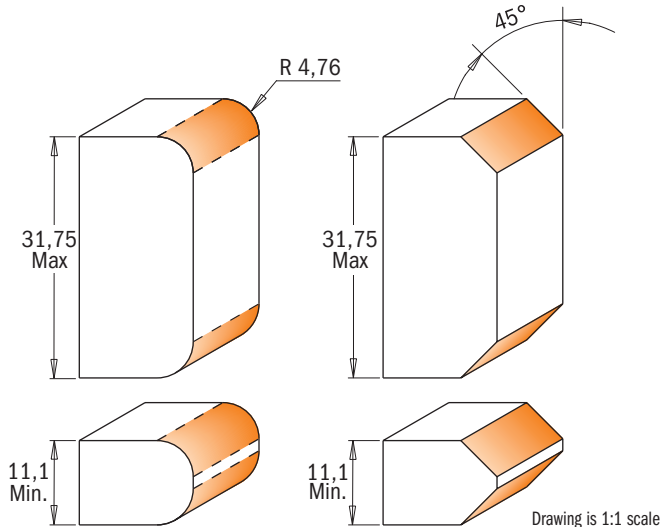

Drawing is 1:1 scale

D mm	T ₁ mm	R mm	A	L mm		ORDER NO. S=∅12mm	ORDER NO. S=∅12,7mm
38,1	11,1 - 31,75	4,76	45°	100	10	900.623.11	
38,1	11,1 - 31,75	4,76	45°	100	10		800.623.11

Spare parts

		45° R	R 45°	
924.137.00	791.037.00	822.029.11	822.030.11	990.020.00
824.137.00	791.037.00	822.029.11	822.030.11	990.020.00

Spare parts: **541.500.00** 3mm spacer
541.515.00 0,1mm spacer
541.517.00 0,5mm spacer

541.518.00 1mm spacer
541.519.00 5,8mm spacer

Adjustable Double Roundover Router Bits

8/900.622



Create awesome furnishing decorations with these new CMT bits! They provide a double 2mm (5/64") and 3mm (1/8") roundover profile on your wood panels easily and in a cost-effective way! To be used on table-mounted routers. Do not use these bits with hand-held power tools. Router tables only.

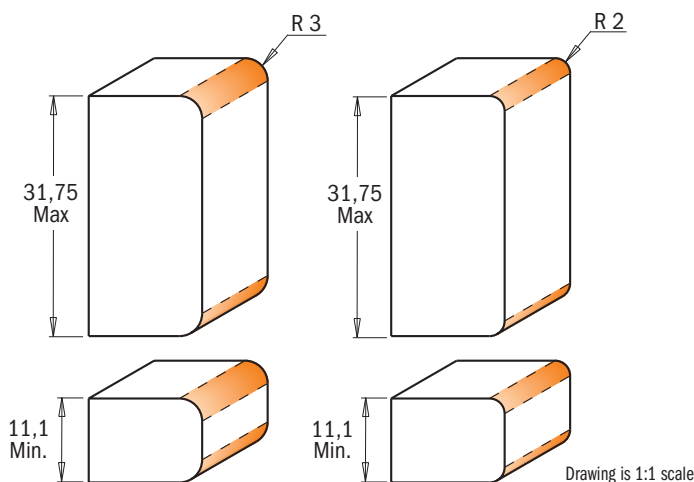
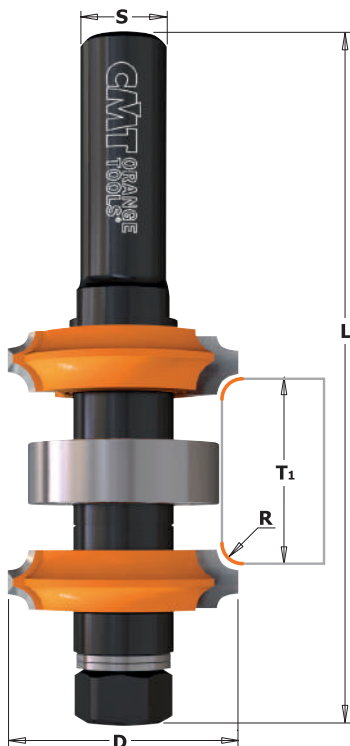

Drawing is 1:1 scale

D mm	T ₁ mm	R mm	L mm		ORDER NO. S=∅12mm	ORDER NO. S=∅12,7mm
34	11,1 - 31,75	3 - 2	100	10	900.622.11	
34	11,1 - 31,75	3 - 2	100	10		800.622.11

Spare parts

		R2 R3	R3 R2	
924.137.00	791.037.00	822.031.11	822.032.11	990.020.00
824.137.00	791.037.00	822.031.11	822.032.11	990.020.00

Spare parts: **541.500.00** 3mm spacer
541.501.00 4mm spacer
541.515.00 0,1mm spacer

541.516.00 0,3mm spacer
541.518.00 1mm spacer
541.519.00 5,8mm spacer

Wainscot/Paneling Bits

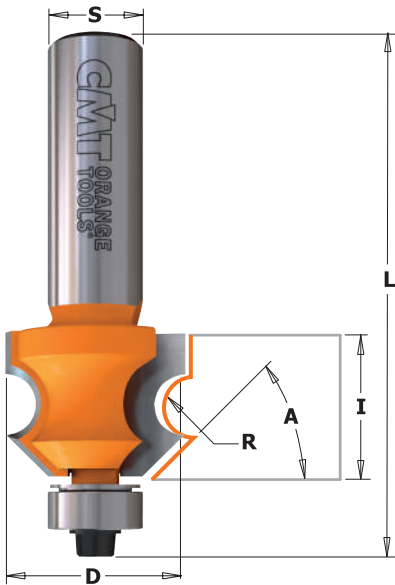

8/961.6

This new router bit designed for 19mm (3/4") thick stock is perfect for creating wainscots and panels on your walls. Simply create a 6,35mm (1/4") tongue-and-groove interlock with a CMT 8/900.626.11, then, with two passes mill an attractive traditional beadboard profile with this new bit. Perfect for cabinets, bookcase backings, ceiling and wall paneling.

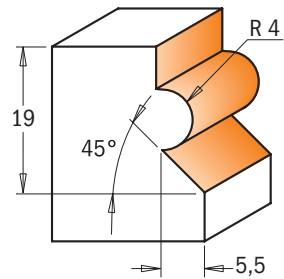
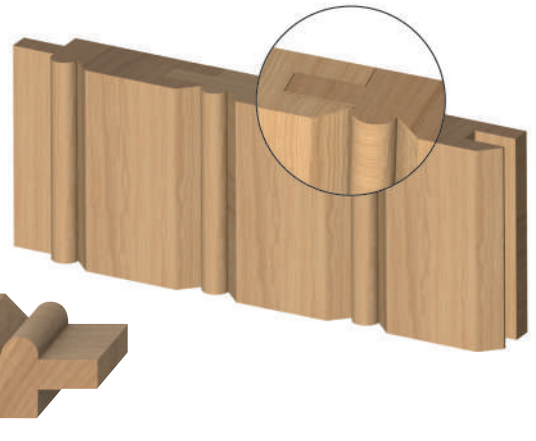

Drawing is 1:1 scale

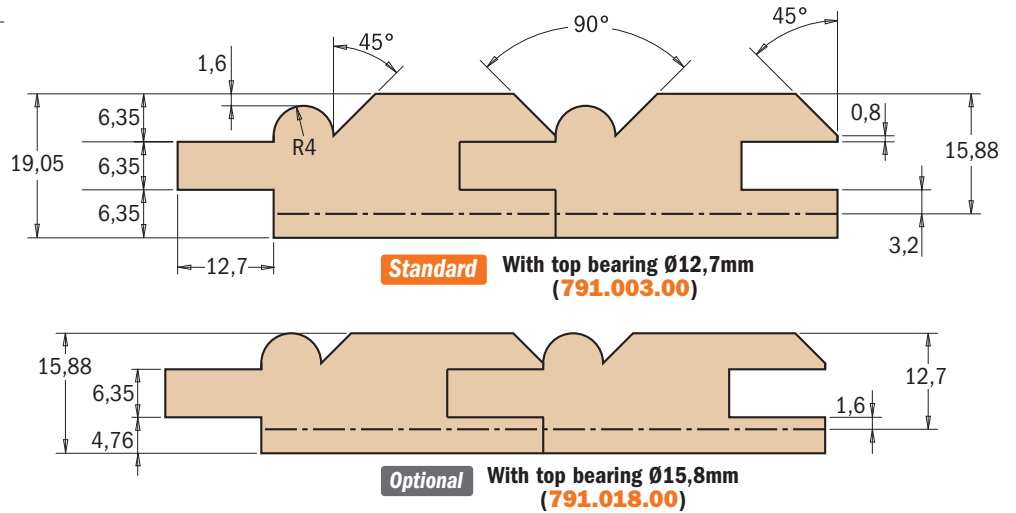

D mm	I mm	R mm	A	L mm		ORDER NO. S=Ø12mm	ORDER NO. S=Ø12,7mm
23,8	19,05	4	45°	67,7	10	961.601.11	861.601.11

Spare parts

990.423.00	791.003.00	990.058.00	991.057.00

SHOP TIPS: after resharpener, replace bearing 791.003.11 (Ø12,7mm) with undersized bearing 791.063.00 (Ø12,5mm)

Corner Beading Bit with 45° Chamfer

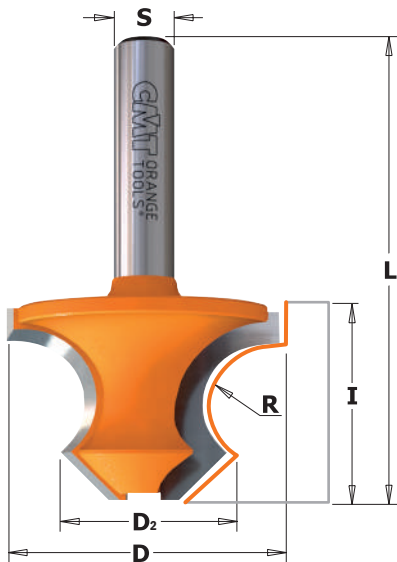

954

An innovative bit to create beautiful edges and corner beads.

SAFETY TIPS: to be used only on CNC machines or router tables equipped with a fence.

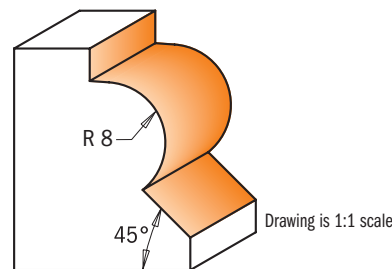

Drawing is 1:1 scale

D mm	D2 mm	I mm	R mm	L mm		ORDER NO. S=Ø8mm
36	22	25	8	60	10	954.080.11

Bead & Bull Nose Bits



7/8/954

CMT's bull nose bits create elegantly finished edges on stair treads, window sills and shelves in one pass. Add a final touch by using a cutter with a bead diameter wider than the stock thickness.

SAFETY TIPS: to be used only on router tables equipped with a fence except in the case Do not remove the work-piece while the bit is routing.

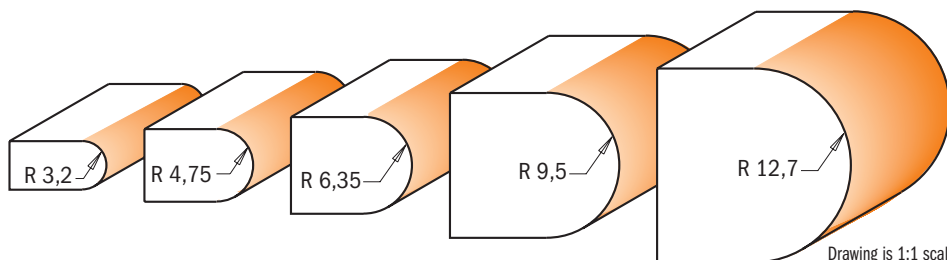
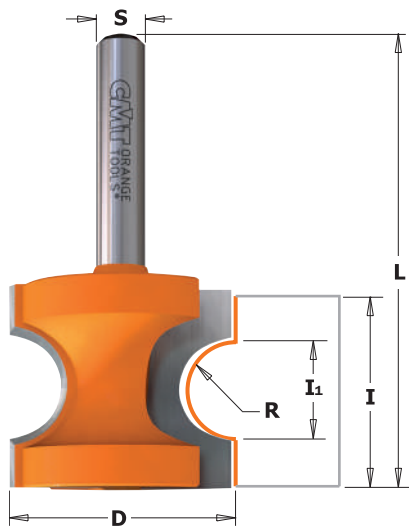

Drawing is 1:1 scale

R mm	D mm	I ₁ mm	I mm	L mm		ORDER NO. S=Ø6mm	ORDER NO. S=Ø6,35mm	ORDER NO. S=Ø8mm	ORDER NO. S=Ø12mm	ORDER NO. S=Ø12,7mm
3,2	22,2	6,56	19	50,8	10	754.002.11	854.002.11	954.002.11		
3,2	22,2	6,56	19	57,2	10				954.502.11	854.502.11
4,75	25,4	9,85	22	54	10	754.003.11	854.003.11	954.003.11		
4,75	25,4	9,85	22	60,4	10				954.503.11	854.503.11
6,35	28,6	13,15	25,5	57,2	10	754.004.11	854.004.11	954.004.11		
6,35	28,6	13,15	25,5	63,5	10				954.504.11	854.504.11
9,5	34,9	19,71	35	73	10				954.507.11	854.507.11
12,7	44,5	26,3	41	79,4	10				954.509.11	854.509.11

Corner Beading Bits



7/8/961

Make beautiful traditional beads and edge beads or turn old beads into new moldings with the new CMT corner beading bits with bearing. Featuring carbide-tipped cutting edges and orange P.T.F.E. non-stick coating, these bits provide excellent results on corner beads. Run the bead twice to form a complete corner bead.

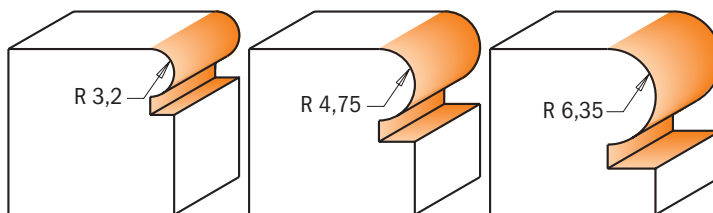
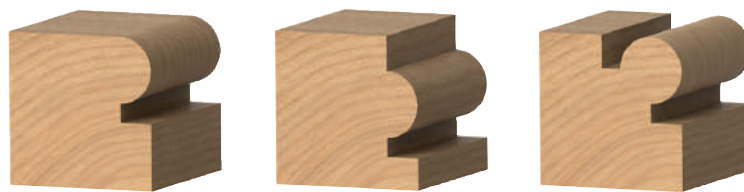
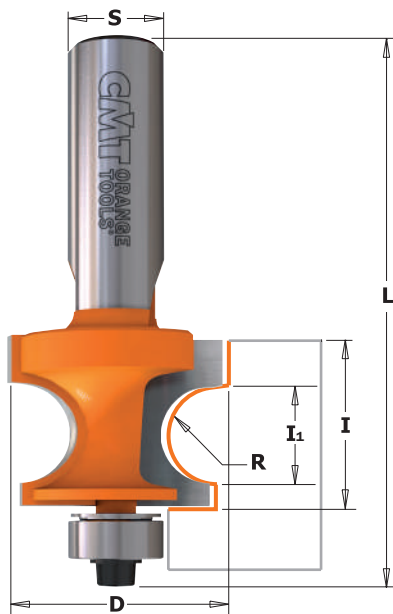

Drawing is 1:1 scale

R mm	D mm	I ₁ mm	I mm	L mm		ORDER NO S=Ø6mm	ORDER NO S=Ø6,35mm	ORDER NO S=Ø8mm	ORDER NO S=Ø12mm	ORDER NO S=Ø12,7mm	Spare parts		
3,2	22,2	6,50	15	57,7	10	761.032.11	861.032.11	961.032.11					
3,2	22,2	6,50	15	64	10				961.532.11	861.532.11	990.423.00	791.003.00	990.058.00
4,75	25,4	9,68	18,6	61,2	10	761.048.11	861.048.11	961.048.11			990.423.00	791.003.00	990.058.00
4,75	25,4	9,68	18,6	67,6	10				961.548.11	861.548.11	990.423.00	791.003.00	990.058.00
6,35	28,6	12,86	22,2	64,8	10	761.064.11	861.064.11	961.064.11			990.423.00	791.003.00	990.058.00
6,35	28,6	12,86	22,2	71,7	10				961.564.11	861.564.11	990.423.00	791.003.00	990.058.00

Spare parts: 991.057.00 3/32" hex key

Edge-Fluting Bits

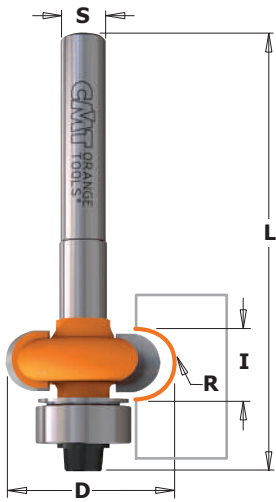

7/862

The edge-fluting bearing guided bits are quick to set up and can be used for curved screens, small radius grooves, doors etc. No side fence is required. Use in a handheld or table-mounted router.



For top bearing version: use bearing **791.010.00** and stop collar **541.001.00** (optional)

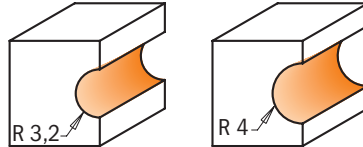

Drawing is 1:1 scale

R mm	D mm	I mm	L mm		ORDER NO. S=∅6mm	ORDER NO. S=∅6,35mm
3,2	19,05	6,4	57	10	762.032.11	862.032.11
4	20,7	8	57	10	762.040.11	862.040.11
5	22,7	10	57	10	762.050.11	862.050.11

Spare parts

990.423.00	791.003.00	990.058.00	991.057.00
990.423.00	791.003.00	990.058.00	991.057.00
990.423.00	791.003.00	990.058.00	991.057.00

CMT Moulding System

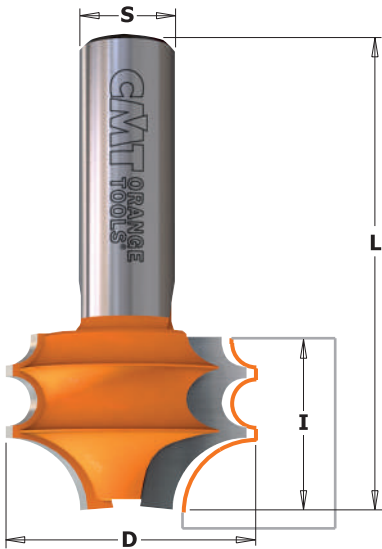

8/956.852

If the standard selection of moulding and mill work you find in today's lumber shops isn't satisfactory to your woodworking tastes, then look to CMT's moulding system instead. With these bits, you can make dozens of elaborate profiles by combining two or more passes. Avoid the average and create your own mouldings. Some initial suggestions are illustrated below.

SAFETY TIPS: use these bits with a fence. The profiles shown below are milled from heavy stock then refined to the desired shape.



8/956.851

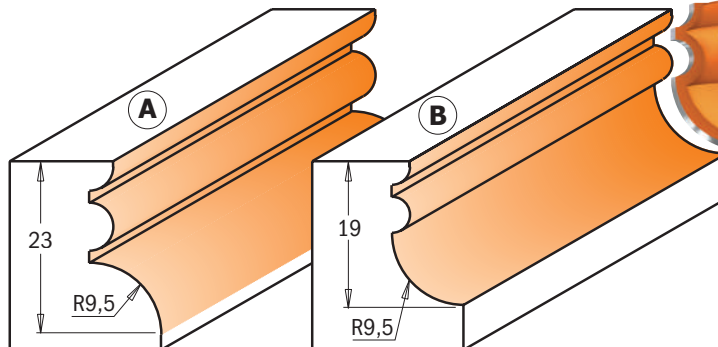

Drawing is 1:1 scale

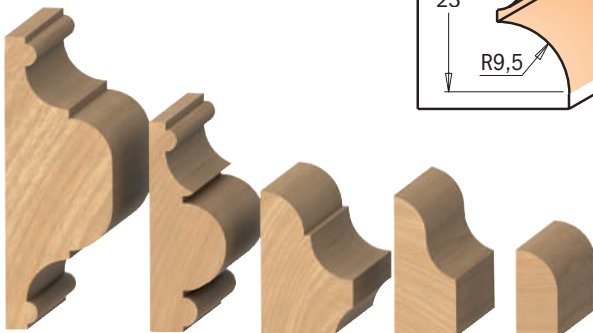

Chair rail 4 passes
Panel molding 3 passes
Base cap 3 passes
Stop 2 passes
Shoe 1 pass

PROFILE	D mm	I mm	L mm		ORDER NO. S=∅12mm	ORDER NO. S=∅12,7mm
A	31,7	23	61,1	10	956.852.11	856.852.11
B	31,7	19	57,2	10	956.851.11	856.851.11

Multiprofile Bits

8/956.8



Create endless profiles with CMT multiprofile bits. Simply adjust the height of the bit to create classic profiles in one single pass, or make more complex decorative effects in multiple passes. The bits super-strength steel body can withstand long-lasting cutting operations, and the micrograin carbide tips remain sharp longer for superior performance. In addition these bits feature non-stick P.T.F.E. coating and anti-kickback design. To be used on tables equipped with a fence.

SAFETY TIPS: to make small mouldings as shown below, cut the profile from large stock, removing excess material as you work as this will facilitate easier control. Keep hands far from the bit when working.

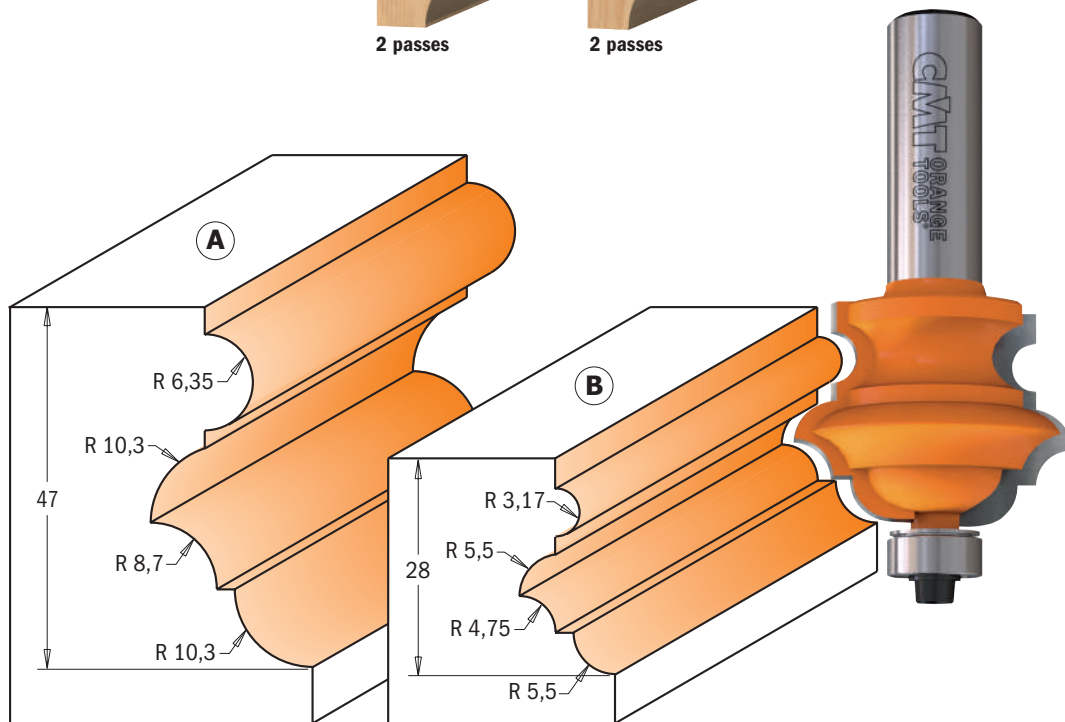
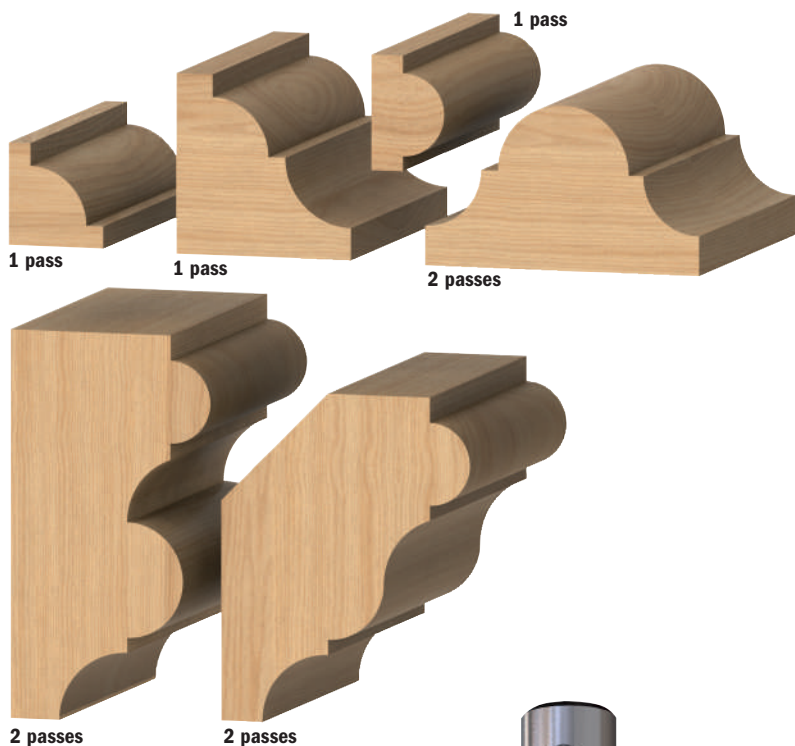
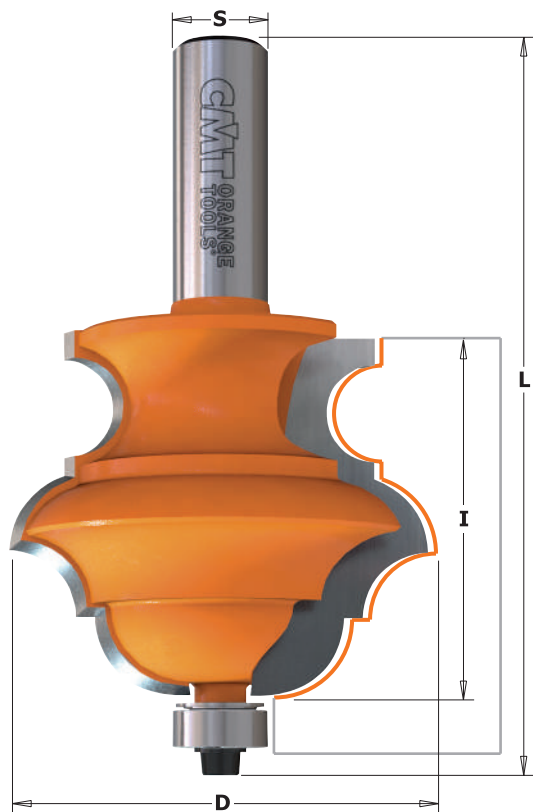

Drawing is 1:1 scale

PROFILE	D mm	I mm	L mm		ORDER NO. S=Ø12mm	ORDER NO. S=Ø12,7mm	Spare parts							
A	55,6	47	96,4	5	956.802.11	856.802.11					990.423.00	791.003.00	990.058.00	991.057.00
B	38,1	28	77,5	10	956.801.11	856.801.11	990.423.00	791.003.00	990.058.00	991.057.00				

Moulding Bits

For best results use these bits with 1800W routers. It is possible to use 1100W routers but only for brief passes that are short in depth.



SHOP TIPS: multiple pass operations require advance planning. To avoid making a mistake that could render it impossible to finish the job, carefully consider the entire cutting sequence before you begin.

SAFETY TIPS: all large diameter bits such as these should be used with caution and on router tables equipped with a fence. When possible, reduce the RPM.

8/955.901

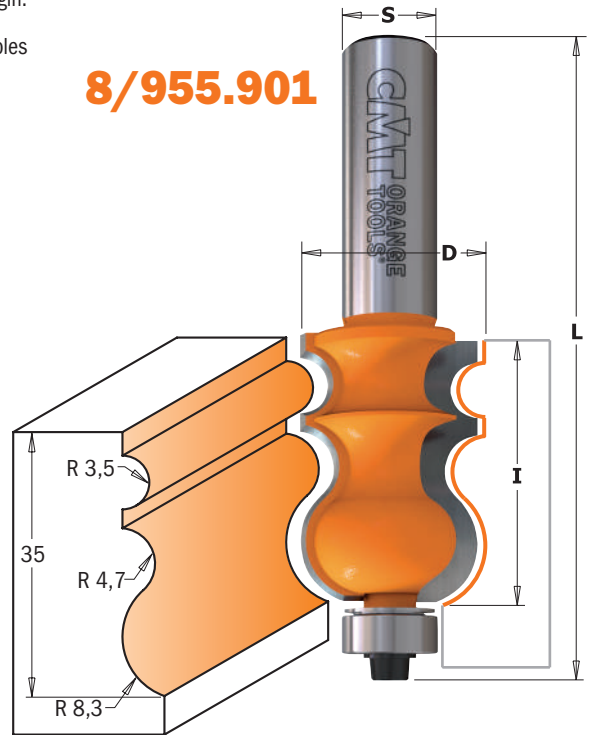

8/956.501

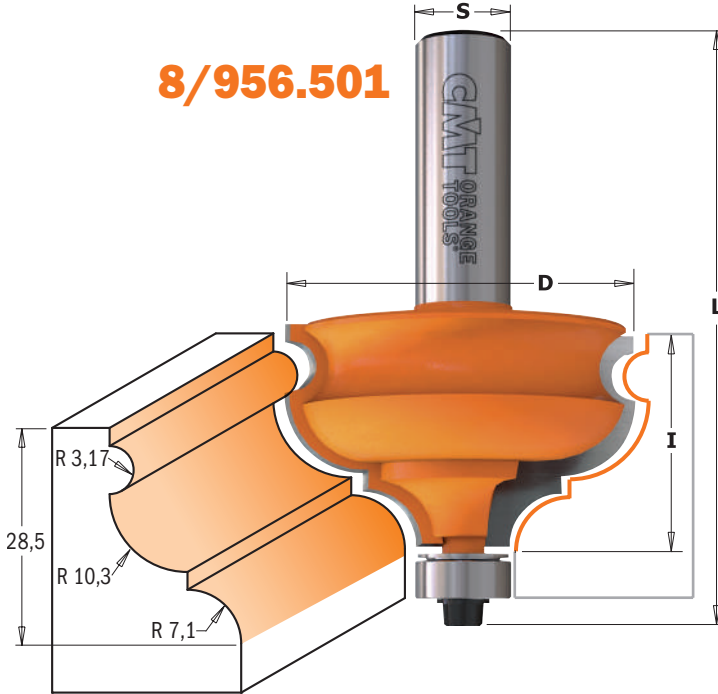

8/955.902

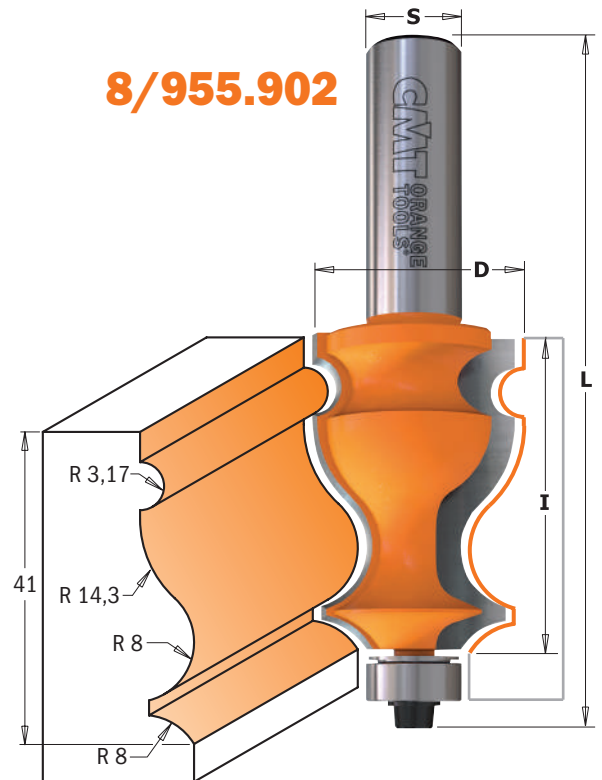

8/967.701

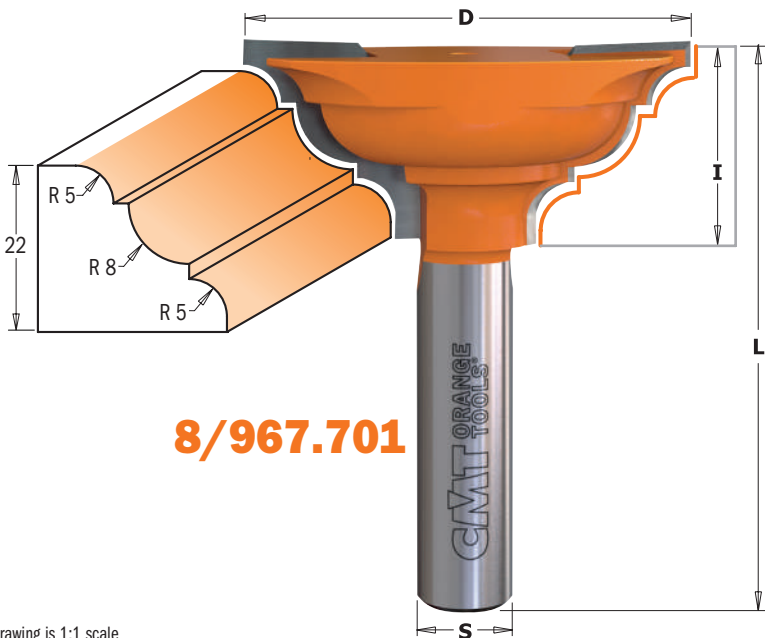

Drawing is 1:1 scale

D mm	I mm	L mm		ORDER NO. S=Ø12mm	ORDER NO. S=Ø12,7mm	Spare parts			
23,8	35	83,8	10	955.901.11	855.901.11				
27	41	90,2	10	955.902.11	855.902.11	990.423.00	791.003.00	990.058.00	991.057.00
47,5	28,5	77,4	10	956.501.11	856.501.11	990.423.00	791.003.00	990.058.00	991.057.00
59	25,4	73,5	10	967.701.11	867.701.11	990.423.00	791.003.00	990.058.00	991.057.00

SHOP TIPS: after resharping, replace bearing 791.003.11 (Ø12,7mm) with undersized bearing 791.063.00 (Ø12,5mm)

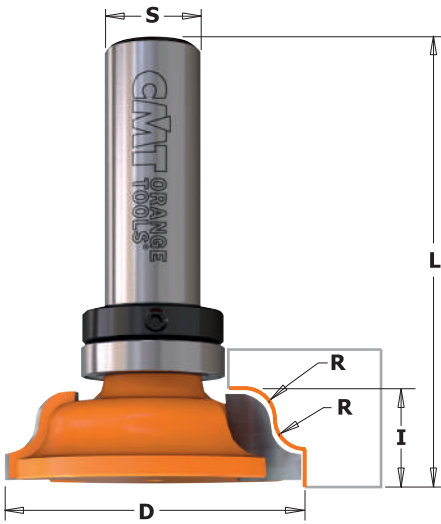

8/967.5B - 8/967.6B



CMT's new moulding bits allow you to shape elegant moldings with your table saw and router. Unlike any commercially available crown moldings, moldings made with these bits are easy to install and create a finished appearance. After shaping the cove, you can use special router bits with inverted profiles to create different edges and complete the moulding.

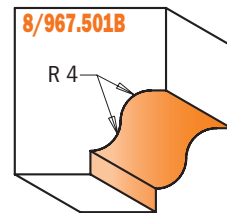
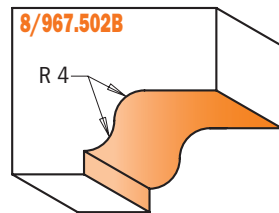
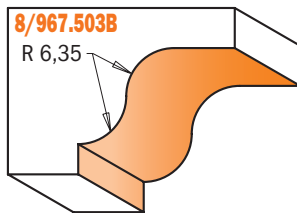
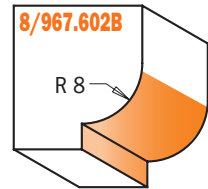
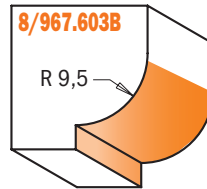

Drawing is 1:1 scale

R mm	D mm	I mm	L mm		ORDER NO. S=Ø8mm	ORDER NO. S=Ø12mm	ORDER NO. S=Ø12,7mm
4	39	11,5	57	10	967.001.11B	967.501.11B	867.501.11B
4	54	11,5	65,9	10		967.502.11B	867.502.11B
6,35	60,5	17,3	71,7	5		967.503.11B	867.503.11B
6,35	38	12,5	57	10	967.101.11B	967.601.11B	867.601.11B
8	35	13,2	57,7	10	967.102.11B	967.602.11B	867.602.11B
9,5	38	14,5	59	10	967.103.11B	967.603.11B	867.603.11B

Spare parts

791.011.00	541.002.00	990.005.00	991.056.00
791.011.00	541.002.00	990.005.00	991.056.00
791.011.00	541.002.00	990.005.00	991.056.00
791.011.00	541.002.00	990.005.00	991.056.00
791.011.00	541.002.00	990.005.00	991.056.00
791.011.00	541.002.00	990.005.00	991.056.00

Door Lip Bit & Finger Grip Bit

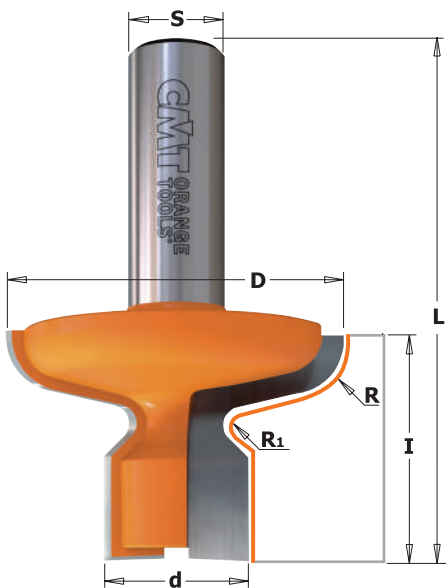

8/955.604-606



Why interrupt the subtle linearity of an all-wood drawer front or cabinet door with a metal knob or handle? Two options are available: a template profile made directly in the wood or a European-style hardwood pull as illustrated below.

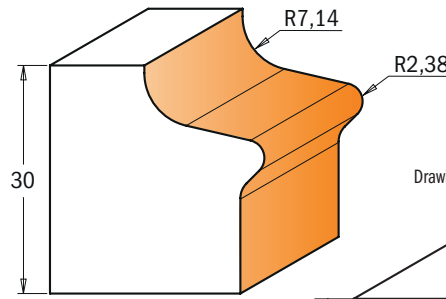

Drawing is 1:1 scale

9/855.604.11

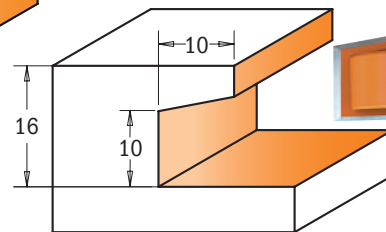

9/855.606.11

D mm	d mm	I mm	R mm	R1 mm	L mm		ORDER NO. S=Ø12mm	ORDER NO. S=Ø12,7mm
36	16	16			60	10	955.606.11	855.606.11
47,6	22,2	30	7,14	2,38	66,6	10	955.604.11	855.604.11

new

Finger Pull Bit

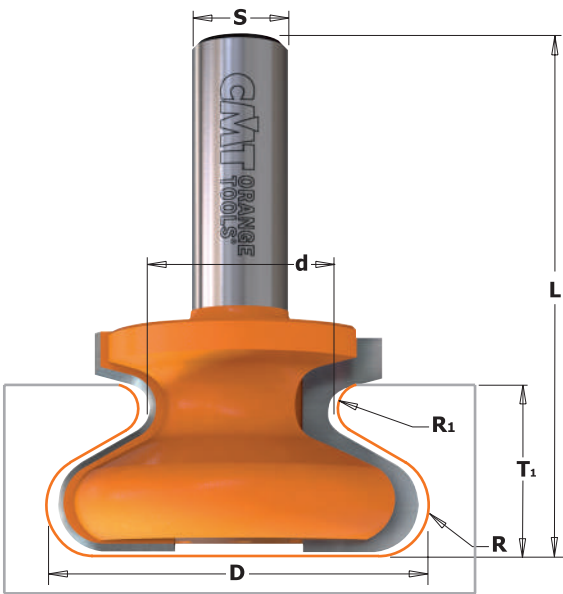

8/955



Why interrupt the subtle linearity of an all-wood drawer front or cabinet door with a metal knob or handle? Use a CMT finger pull bit and make a harmonious wooden handle. Two options are available: a template profile made directly in the wood or a European-style hardwood pull as illustrated below.

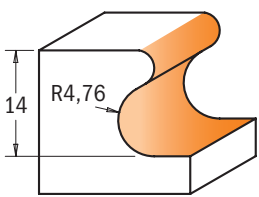
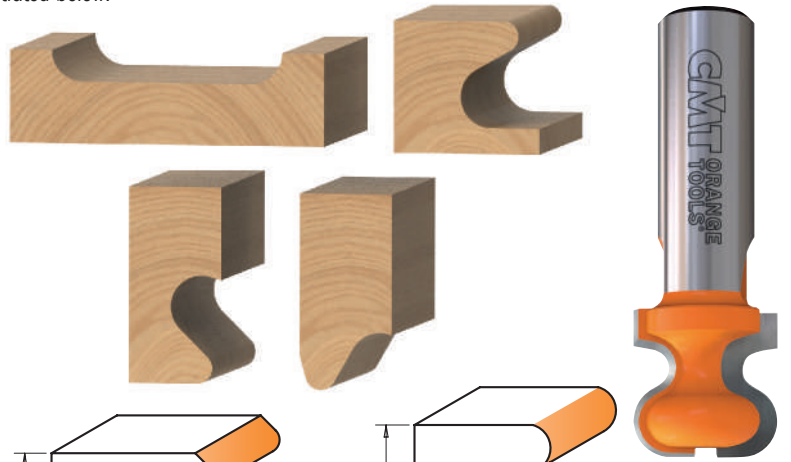

955.102.11
855.602.11

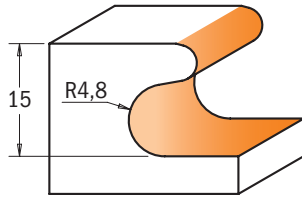

955.105.11
955.605.11
855.605.11

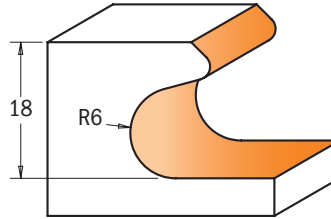

955.103.11
855.603.11

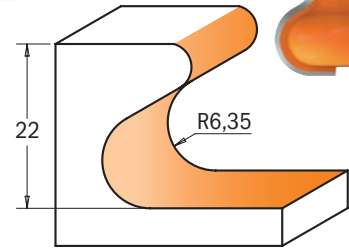

955.601.11
855.601.11

Drawing is 1:1 scale

D mm	d mm	T ₁ mm	l mm	R mm	R ₁ mm	L mm		ORDER NO. S=Ø8mm	ORDER NO. S=Ø12mm	ORDER NO. S=Ø12,7mm
19,05	9,5	14	19,05	4,76	2,4	57,2	10	955.102.11		855.602.11
29	11	15	20	4,8	2,3	60	10	955.105.11	955.605.11	855.605.11
38,1	17	18	20,7	6	1,8	55,5	10	955.103.11		855.603.11
38,1	17	18	20,7	6	1,8	61,8	10			855.603.11
47,6	24	22	28,5	6,35	3,2	66,6	10		955.601.11	855.601.11

new

Window Sill & Finger Bits

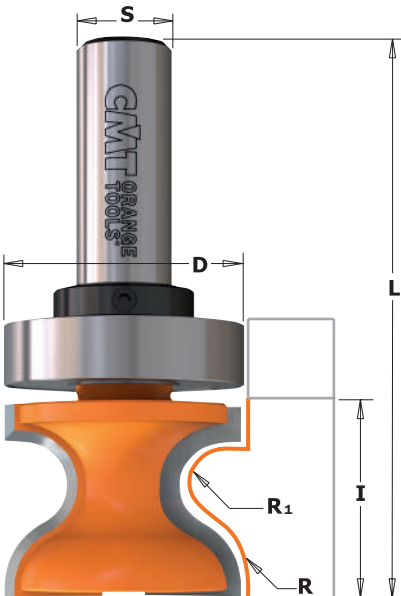

8/955.8 - 8/955.8B



Originally, these profiles were designed for shaping the edges of window sills. Yet, these bits also can be used to create finger pulls on the edges of doors and drawers. These bits are available with top bearings for curved work or without bearings for straight work against a fence. Recommended for router table use only.

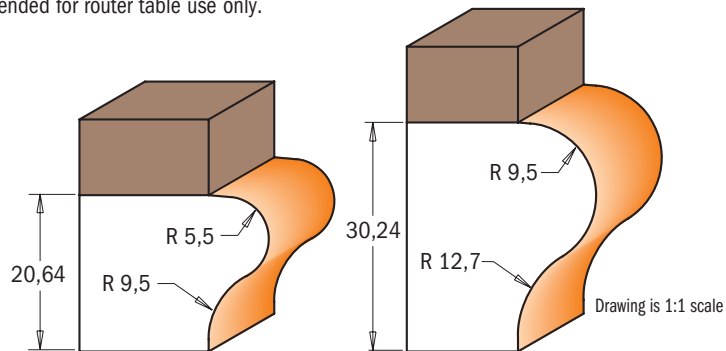

Drawing is 1:1 scale

R ₁ mm	R mm	D mm	I mm	L mm		ORDER NO. S=Ø12mm	ORDER NO. S=Ø12,7mm
5,5	9,5	31,7	25,4	73	10	955.804.11	855.804.11
9,5	12,7	38,1	35	85,8	10	955.805.11	855.805.11
With top bearing							
5,5	9,5	31,7	25,4	73	10	955.804.11B	
5,5	9,5	31,7	25,4	73	10		855.804.11B
9,5	12,7	38,1	35	85,8	10	955.805.11B	
9,5	12,7	38,1	35	85,8	10		855.805.11B

Spare parts

791.015.00	541.005.00	990.005.00	991.056.00
791.015.00	541.002.00	990.005.00	991.056.00
791.020.00	541.005.00	990.005.00	991.056.00
791.020.00	541.002.00	990.005.00	991.056.00

Table Edge & Hand Rail Bits

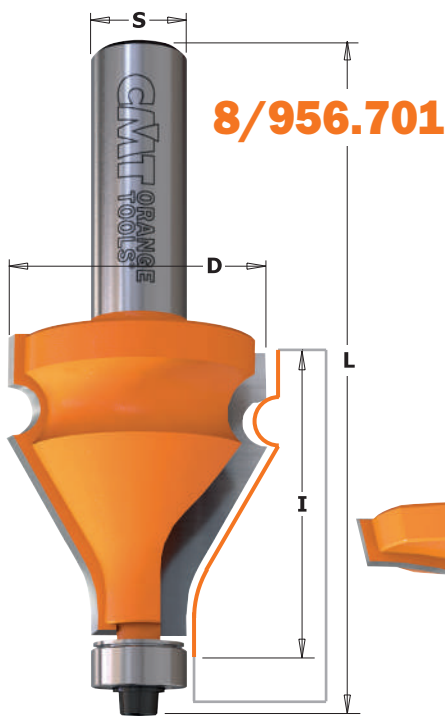

8/956.701

The **8/956.601.11** guarantees well-proportioned smooth curves. Complete the job with the **8/956.701.11** bit featuring a 30° bevel edge and a 3.2mm bead for beautifully functional hand rails.

SAFETY TIPS: these profile bits remove large amounts of stock and produce consistent quantities of dust. We recommend using a vacuum to keep the work area safe.

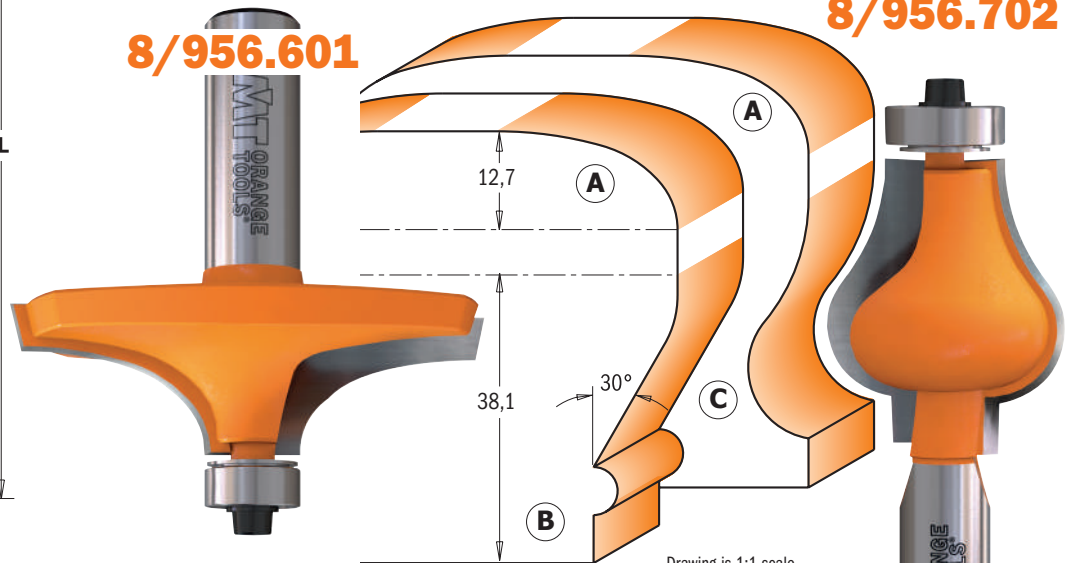

8/956.601

8/956.702

Drawing is 1:1 scale

PROFILE	D mm	I mm	L mm		ORDER NO. S=Ø12mm	ORDER NO. S=Ø12,7mm
A	63,5	19	67,9	5	956.601.11	856.601.11
B	35	38	87	10	956.701.11	856.701.11
C	31,7	38,1	87	10	956.702.11	856.702.11

Spare parts

990.423.00	791.003.00	990.058.00	991.057.00
990.423.00	791.003.00	990.058.00	991.057.00
990.423.00	791.018.00	990.058.00	991.057.00

SHOP TIPS: after resharpening, replace bearing 791.003.11 (Ø12,7mm) with undersized bearing **791.063.00** (Ø12,5mm)

Vertical Raised Panel Bits

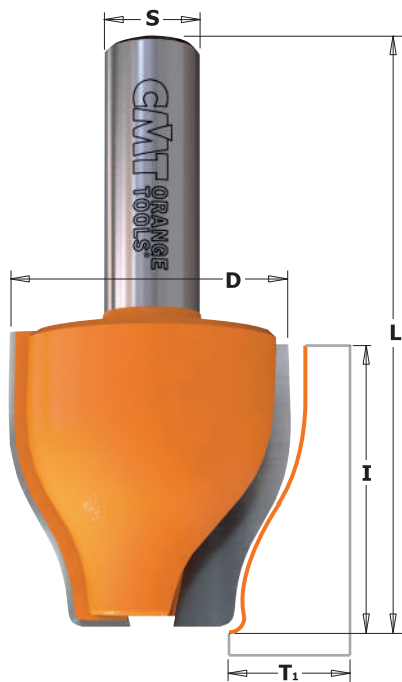

8/990.6



Use a sturdy 90° angle fence on your router table along with routers with a minimum speed of 1,7 KW (2-1/4 HP). Routers as low-powered as 1,1 KW (1-1/2 HP) can be used but we suggest limiting their use to shorter, shallower runs.

SAFETY TIPS: the template must be at least 150mm and clamps should be used whenever possible. Three to five passes are recommended to safely and accurately obtain the profile you desire.

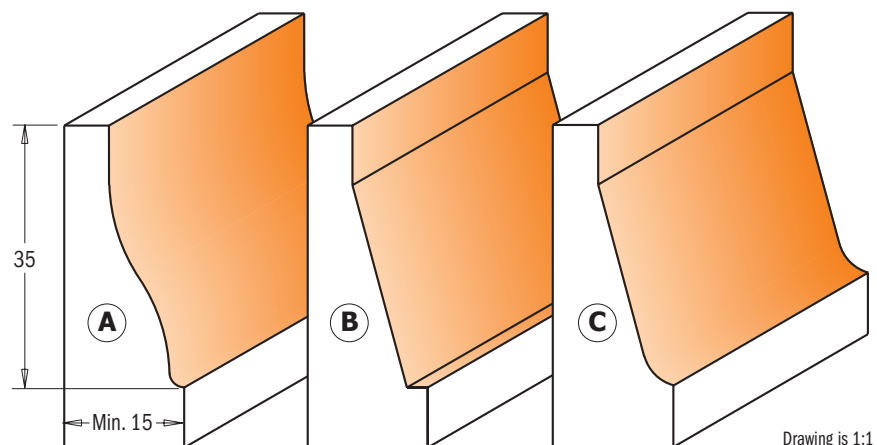

Drawing is 1:1 scale

PROFILE	D mm	I mm	T ₁ mm	L mm		ORDER NO. S=Ø12mm	ORDER NO. S=Ø12,7mm
A	38	38	15 ÷ 18	76,2	10	990.601.11	890.601.11
B	38	38	15 ÷ 18	76,2	10	990.602.11	890.602.11
C	38	38	15 ÷ 18	76,2	10	990.603.11	890.603.11

Junior Ogee Rail & Stile Set

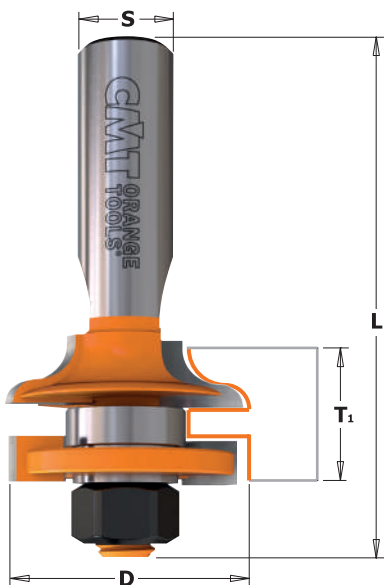

8/991.517



These bits are designed for those special projects that require a smaller panel door. Use these bits with stock from 11,1mm to 17,4mm thick, and build doors as small as 70mm.

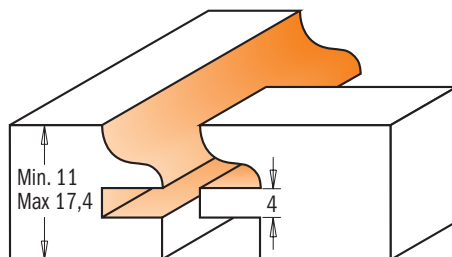

Drawing is 1:1 scale

D mm	T ₁ mm	L mm		ORDER NO. S=Ø12mm	ORDER NO. S=Ø12,7mm	Spare parts							
31,75	11 ÷ 17,4	67	5	991.517.11	891.517.11					822.008.11	822.009.11	791.025.00	990.020.00

Spare parts: 541.515.00 0,1mm spacer
541.516.00 0,3mm spacer
541.518.00 1,0mm spacer

Rail & Stile Set

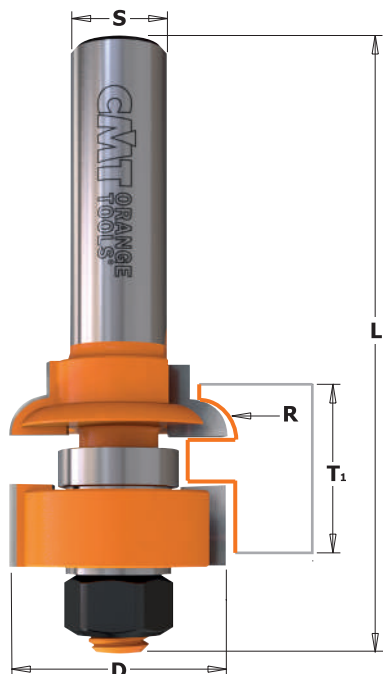

8/991



Designed for fine furniture construction, these bits mill a delicate 4,75mm thumb-nail profile in stock from 15,8mm to 20,6mm.

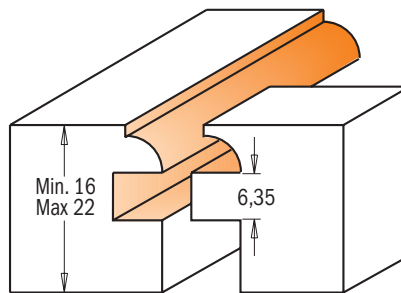

Drawing is 1:1 scale

D mm	T ₁ mm	R mm	L mm		ORDER NO. S=Ø8mm	ORDER NO. S=Ø12,7mm	Spare parts							
28,7	16 ÷ 22	4,8	79,2	10	991.012.11	891.512.11					822.011.11	822.012.11	791.025.00	990.020.00

Spare parts: 541.515.00 0,1mm spacer
541.516.00 0,3mm spacer
541.518.00 1,0mm spacer

The ABC's of Panel Door Construction

In our step-by-step example of panel door construction, we used the following:

- CMT Rail & Stile set (item **891.502.11**)
- CMT Reverse Glue Joint (item **855.501.11**)
- pre-cut to length stiles - 19mm thick x 57mm wide
- pre-cut to length rails - 19mm thick x 57mm wide
- panel - 16mm thick
- scrap stock

The CMT Rail & Stile set was designed ideally for the construction of panel doors from 19mm thick stock, however any variation of size up to 22mm thick can be used. Remember to adjust your measurements and cutting depths according to the wood thickness you use.

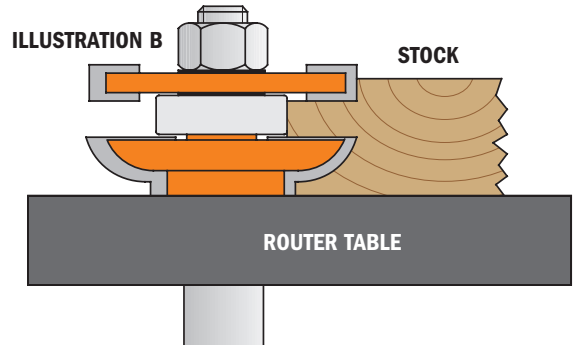
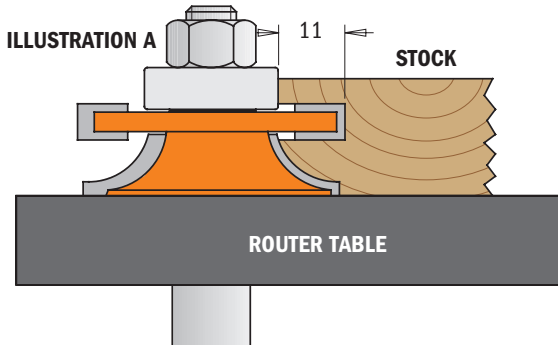
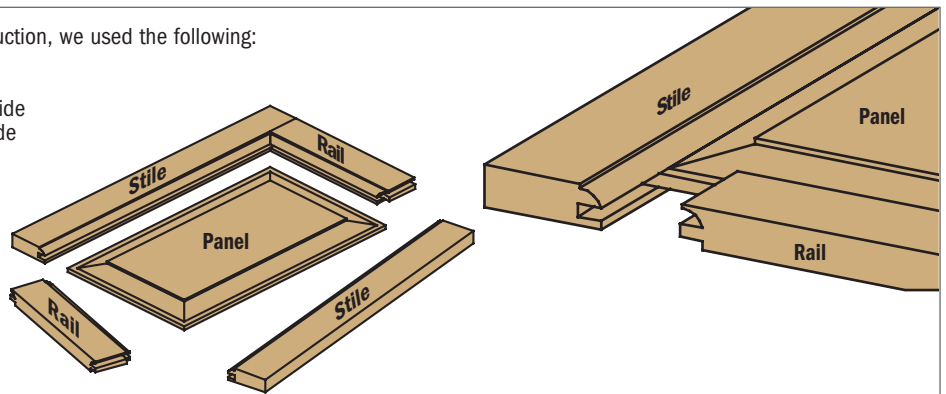

MILLING THE RAILS AND STILES

First make trial cuts of the cope profile (rail) and the stick profile (stile) in scrap stock and check the accuracy of the joint. This is extremely important when working at maximum thickness (22mm). Make sure your stock is flat and cut straight with square edges. Using the CMT Stile Bit shown in illustration A, place the stock front face-down on the router table and mill the cope profile in the stile and rail pieces. To mill the rails, use the CMT Rail Bit shown in illustration B, position the rails face-down on the router table and mill the cope profile on the ends. If you are milling cope and stick profiles before cutting the rails and stiles to length, be sure to make the proper calculations before cutting the rails. The stiles are the same length as the door. The rails must be calculated by the following equation (CMT standard tenon length is 22mm):

(total door width - sum of stile widths) + sum of 2 tenons = total rail length
 therefore, using our example measurements listed above, for a 300mm cabinet door:
 $300\text{mm} - 114\text{mm} + 22\text{mm} = 208\text{mm}$

GLUEING UP PANELS

If the panel requires a width greater than the width of your stock, you will need to edge glue stock for the central floating panel. This is accomplished by simply using the CMT Reverse Glue Joint bit. For making a two panel glue joint, place the first panel front face-down on the router table and accurately centre the wood to the bit. Adjust the bit according to the thickness of the wood you are cutting by lining up the cut edge of the wood to the centre point of the bit as illustrated in illustration B and mill the cut edge of the wood. Place the second panel front face up and repeat the milling process. This assures you will have the best side of your stock as a front face. If a third panel is required, mill one cut edge of the piece as instructed above, turn the piece over and run the other edge. Assemble the reverse cut pairs together for beautiful, strong joints that match up perfectly.

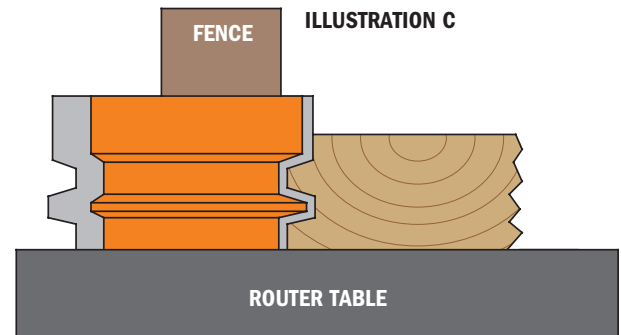

MILLING THE FLOATING PANEL

Make trial cuts in scrap stock to create a tongue that fits snugly into the groove in the stile without forcing it. To cut your panel to size be sure to make the proper calculations, taking into account the length of the tongue. The CMT Raised Panel Bit in our example has a standard tongue length of 8mm (The New CMT Raised Panel Bit profile has a 9,5mm tongue).

Use the following equation:

$$(\text{Total door length} - \text{Sum of Stile widths}) + \text{Sum of 2 Tongues} = \text{Overall Panel Length}$$

Therefore, using our example, measurements listed above for a 600mm long cabinet door: $(600 - 114) + 16\text{mm} = 502\text{mm}$

And accordingly:

$$(\text{Total door width} - \text{Sum of Stile widths}) + \text{Sum of 2 Tongues} = \text{Overall Panel Width}$$

Once the panel has been cut to proper dimensions, position the panel front face side down on the router table tongue as shown in illustration C and use the CMT Raised Panel Bit to mill the tongue. **ATTENTION:** this bit is capable of removing large amounts of stock. To safely and effectively produce the profile you want, we suggest making several shallow passes. It can be dangerous to try to mill the entire profile in a single run.

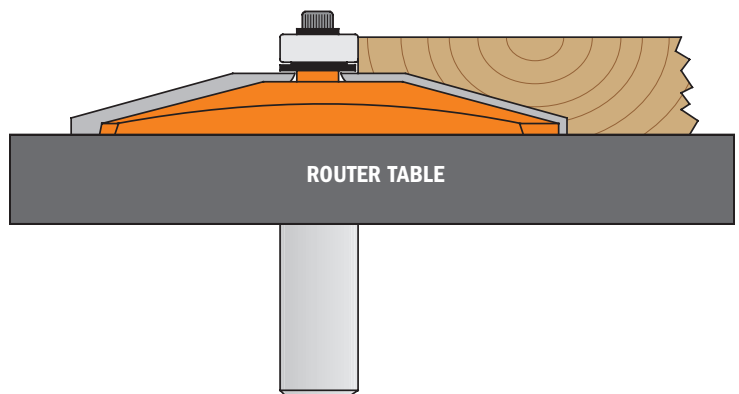

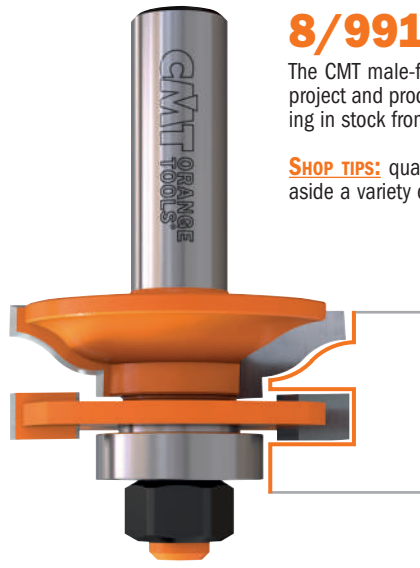
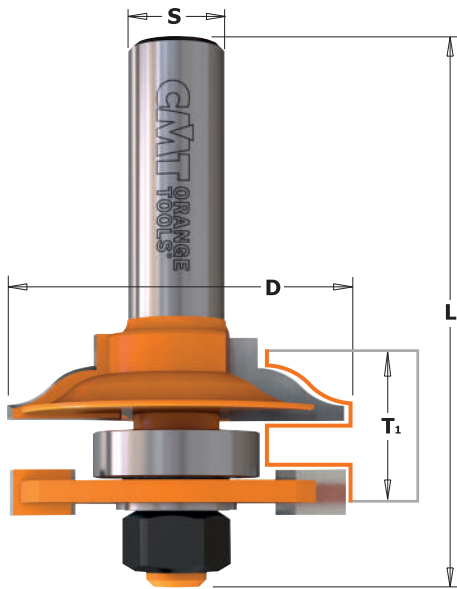

8/991



The CMT male-female rail and stile sets are a perfect pair for this particular project and produce clean, precise and well-crafted joints. Designed for working in stock from 18mm to 22mm.

SHOP TIPS: quality workmanship is the result of a lot of trial and error. Set aside a variety of small pieces for trial cuts.

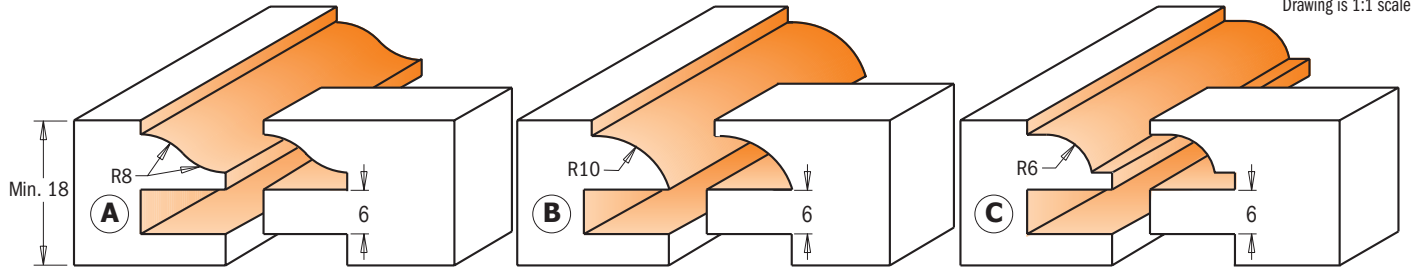

Drawing is 1:1 scale

PROFILE	D mm	L mm	T ₁ mm	Box	ORDER NO. S=Ø8mm	ORDER NO. S=Ø12mm	ORDER NO. S=Ø12,7mm	Spare parts					
								822.003.11	791.012.00	541.515.00	514.516.00	990.407.00	990.020.00
A	44,4	71	18 ÷ 22	5	991.001.11	991.501.11	891.501.11	822.003.11	791.012.00	541.515.00	514.516.00	990.407.00	990.020.00
B	44,4	71	18 ÷ 22	5	991.502.11	891.502.11	822.003.11	791.012.00	541.515.00	514.516.00	990.407.00	990.020.00	
C	44,4	71	18 ÷ 22	5	991.503.11	891.503.11	822.003.11	791.012.00	541.515.00	514.516.00	990.407.00	990.020.00	

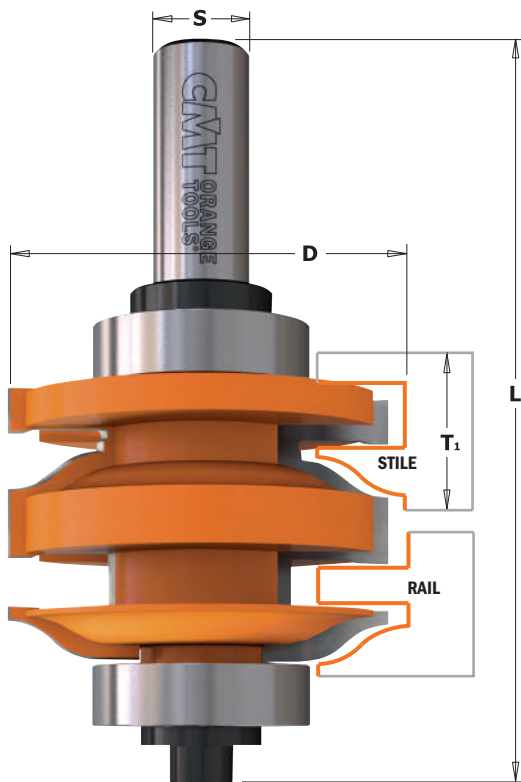

8/991.521



The new CMT One-Piece Rail and Stile Bit represents the union of two cutters in one bit. By simply adjusting the height of the bit, you can cut two perfectly joining profiles with no wasted time or effort moving the fence or changing the bit. Save time and money by investing in one single CMT cutting tool.

SHOP TIPS: the complicated nature of this kind of project requires a lot of practice and you need to carry out trial cuts. Always keep a variety of test pieces on hand.

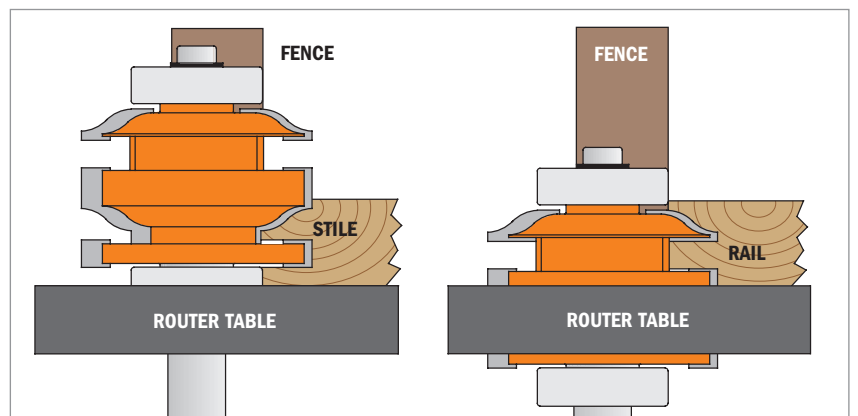

PROFILE	D mm	L mm	T ₁ mm	Box	ORDER NO. S=Ø12mm	ORDER NO. S=Ø12,7mm	Spare parts						
							791.027.00	541.002.00	990.005.00	991.056.00	541.551.00	990.010.00	991.064.00
A	50,87	96	18 ÷ 22	10	991.521.11	891.521.11	791.027.00	541.002.00	990.005.00	991.056.00	541.551.00	990.010.00	991.064.00
A	50,87	96	18 ÷ 22	10	991.521.11	891.521.11	791.027.00	541.005.00	990.005.00	991.056.00	541.551.00	990.010.00	991.064.00

Raised Panel Bits



8/990

Make classic raised panel doors by choosing from the profiles illustrated below. Its anti-kickback design is fundamental in further improving safety when working with larger diameter bits.

SAFETY TIPS: This type of bit needs to be used at a lower rotational speed, preferably between 10,000 and 12,000 RPMs. Three to five passes are recommended to safely and accurately obtain the profile you desire. To be used on routers with at least 1800 KW.

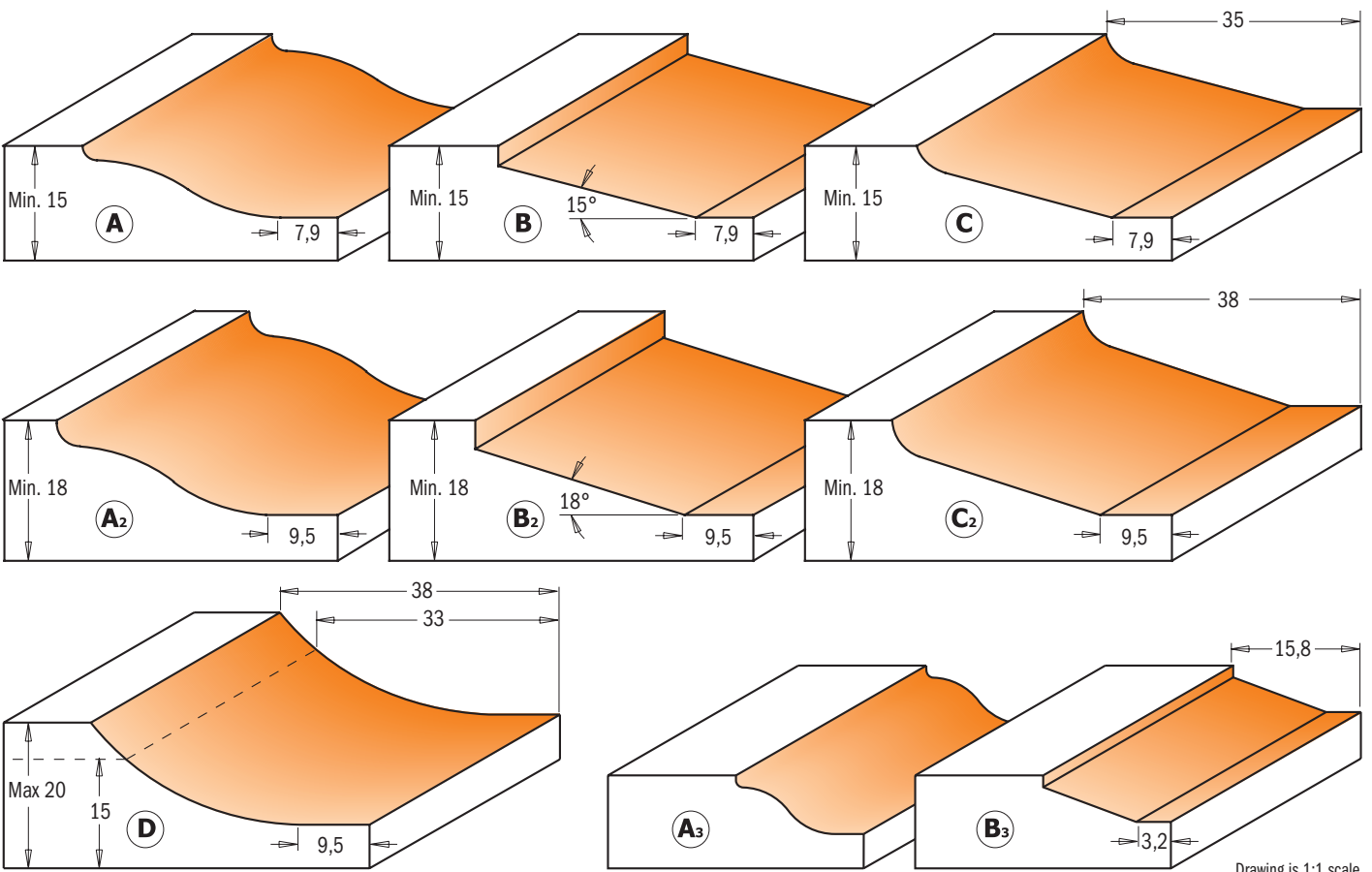
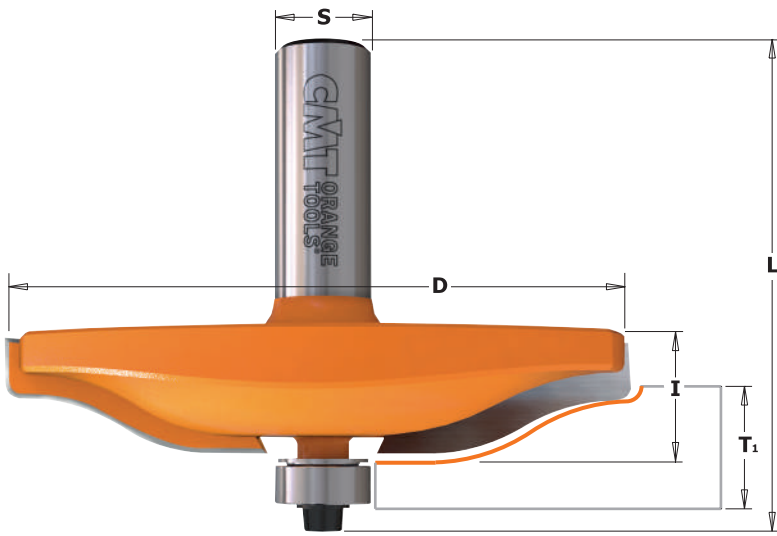

Drawing is 1:1 scale

PROFILE	D mm	I mm	L mm	T ₁ mm		ORDER NO. S=Ø8mm	ORDER NO. S=Ø12mm	ORDER NO. S=Ø12,7mm
A	82,5	15	63,8	15 ÷ 18	5		990.501.11	890.501.11
B	82,5	15	63,8	15 ÷ 18	5		990.502.11	890.502.11
C	82,5	15	64,6	15 ÷ 18	5		990.503.11	890.503.11
A ₂	89	15	64,6	18 ÷ 20	5		990.504.11	890.504.11
B ₂	89	15	64,6	18 ÷ 20	5		990.505.11	890.505.11
C ₂	89	15	64,6	18 ÷ 20	5		990.506.11	890.506.11
D	89	15	64,6	15 ÷ 20	5		990.507.11	890.507.11
A ₃	47,6	9,5	58,1	12,7 ÷ 15	10	990.011.11		
B ₃	47,6	9,5	58,1	12,7 ÷ 15	10	990.012.11		890.512.11

Spare parts

990.423.00	791.003.00	990.058.00	991.057.00
990.423.00	791.003.00	990.058.00	991.057.00
990.423.00	791.003.00	990.058.00	991.057.00
990.423.00	791.003.00	990.058.00	991.057.00
990.423.00	791.003.00	990.058.00	991.057.00
990.423.00	791.003.00	990.058.00	991.057.00
990.423.00	791.003.00	990.058.00	991.057.00
990.423.00	791.003.00	990.058.00	991.057.00
990.423.00	791.003.00	990.058.00	991.057.00

Raised Panel Bit with Back Cutter



8/990.5



These bits have a back-cutter which allows you to rout both the front and back of the panel in the same cut which saves time and money.

SAFETY TIPS: to ensure improved safety when using the Ø89mm bit, carry out the cut in 2 shallow passes: use a Ø37mm bearing for the first pass, and then a Ø16mm bearing for the second pass.

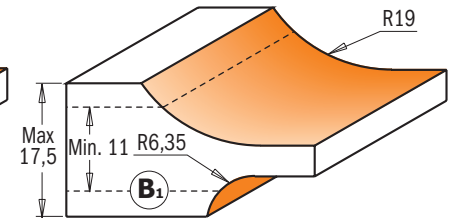
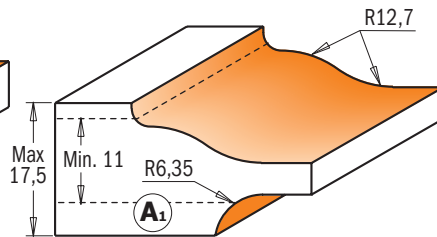
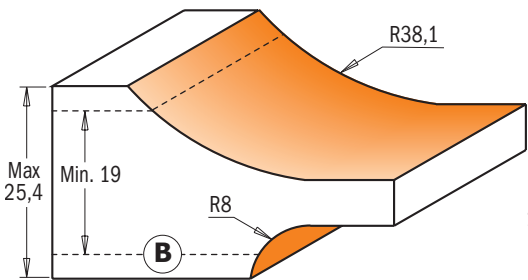
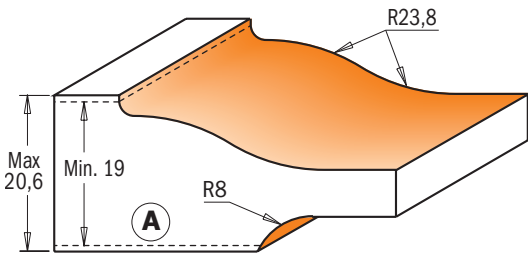
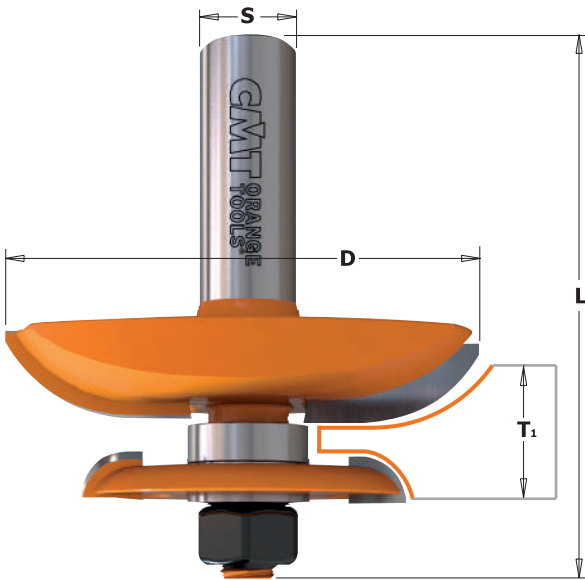

Drawing is 1:1 scale

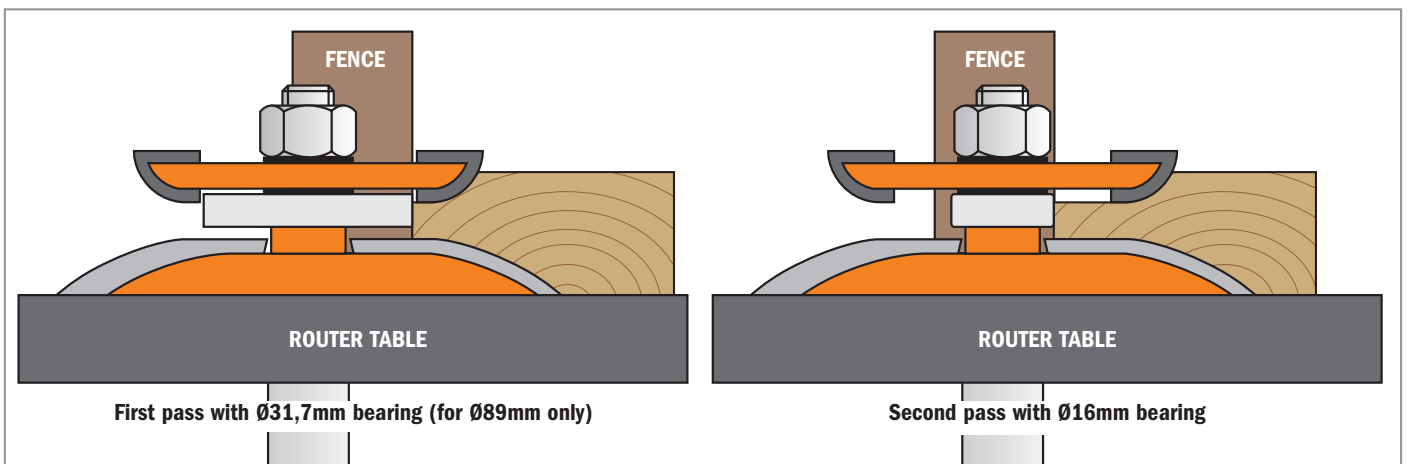

PROFILE	D mm	T ₁ mm	L mm		ORDER NO. S=Ø12mm	ORDER NO. S=Ø12,7mm	Spare parts			
A	89	19 - 20,6	78,1	5	990.524.11	890.524.11				
B	89	19 - 25,4	78,1	5	990.527.11	890.527.11	822.007.11	791.025.00	791.033.00	990.020.00
A ₁	63,5	11,1 - 17,5	70	5	990.534.11	890.534.11	822.010.11	791.025.00		990.020.00
B ₁	63,5	11,1 - 17,5	70	5	990.537.11	890.537.11	822.010.11	791.025.00		990.020.00

Spare parts: 541.515.00 0,1mm spacer
541.516.00 0,3mm spacer

541.518.00 1,0mm spacer
990.407.00 Shield conical

Stile & Panel Router Bits



8/970

These bits can be used for decorative work on solid wood panels and MDF materials. Use them in one pass or in combination with CMT's MDF panel bits for complex and intricate profiles. A simple approach for an elegant appearance.

Featuring large cutting diameters and available in the most popular profiles, these panel bits guarantee excellent performance.

PANEL BITS

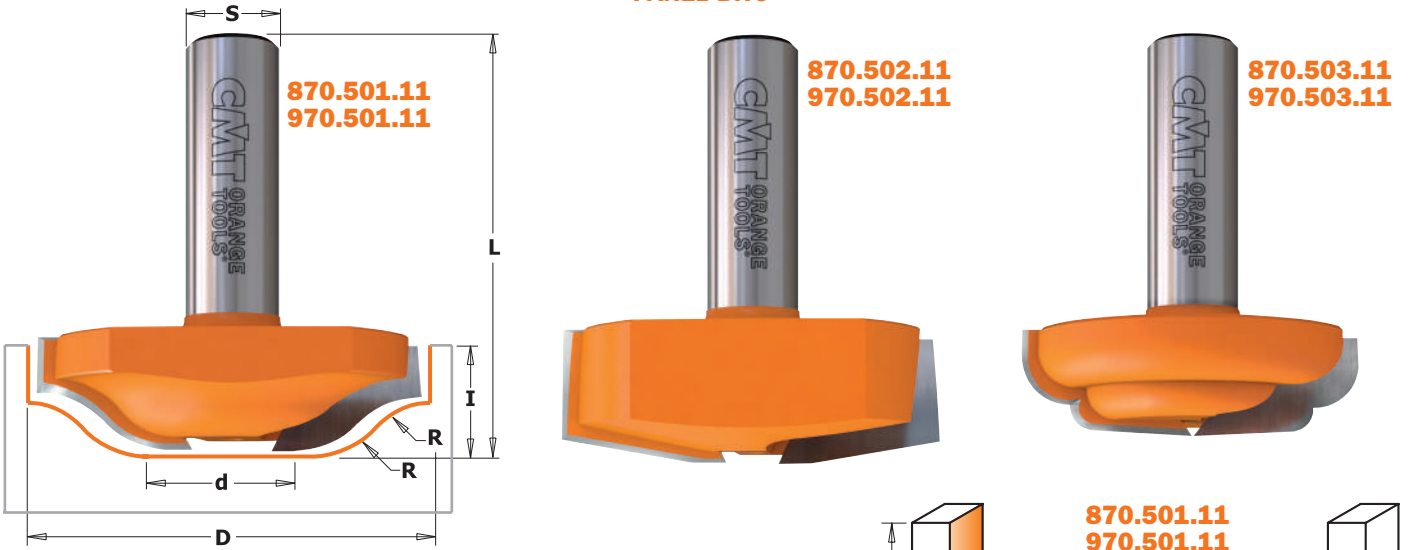

STILE BITS

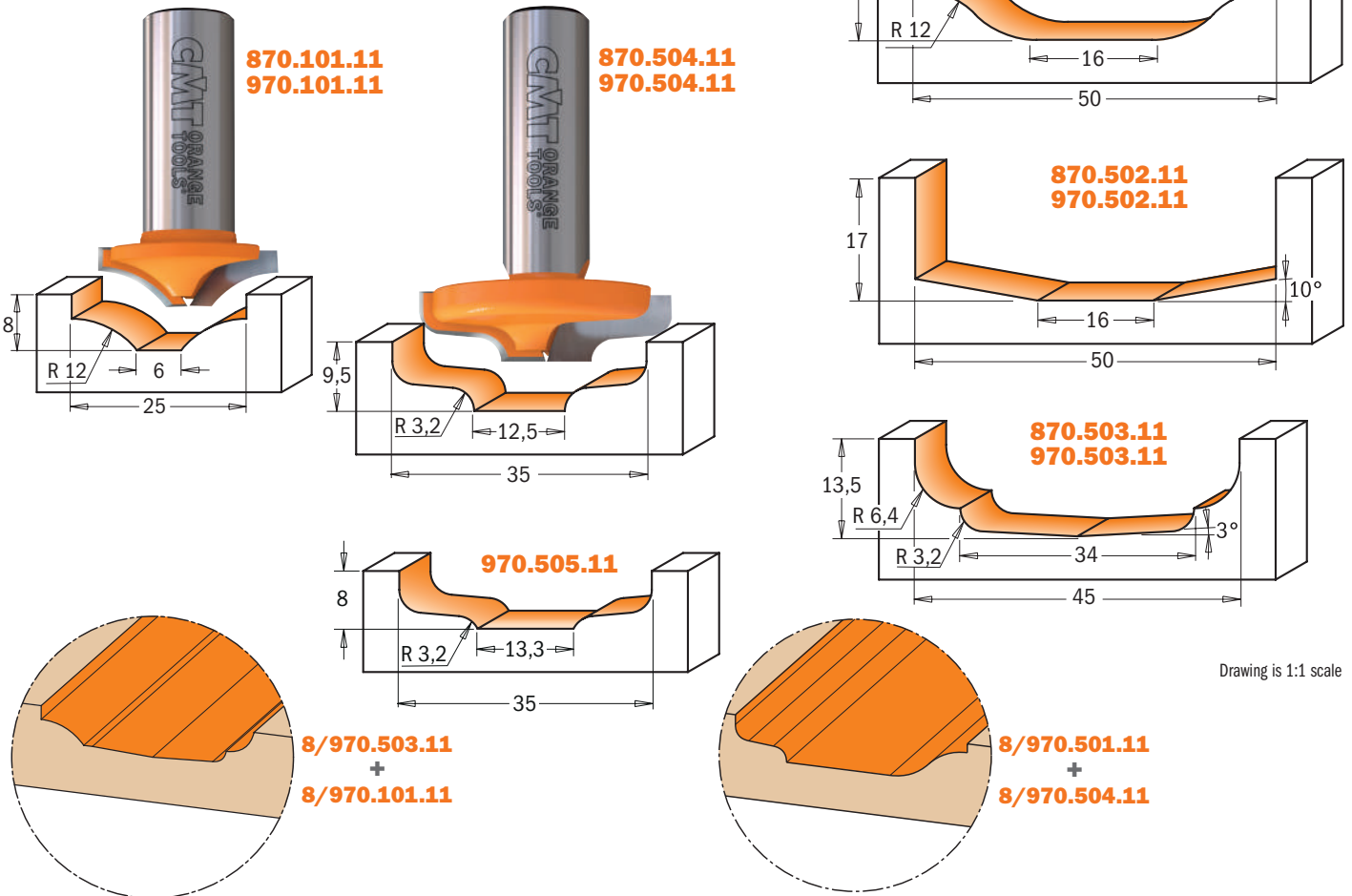

D mm	d mm	l mm	R mm	A	L mm		ORDER NO. S=∅8mm	ORDER NO. S=∅12mm	ORDER NO. S=∅12,7mm
25	6	8	12		39,8	10	970.101.11		870.101.11
50	16	14	12		52,1	10		970.501.11	870.501.11
50	16	17		10°	55,1	10		970.502.11	870.502.11
45	34	13,5	3,2 - 6,4	3°	51,6	10		970.503.11	870.503.11
35	12,5	9,5	3,2		47,6	10		970.504.11	870.504.11
35	13,3	8	3,2		46	10		970.505.11	

3-Flute Slot Cutter for STRIPLOX® Mini

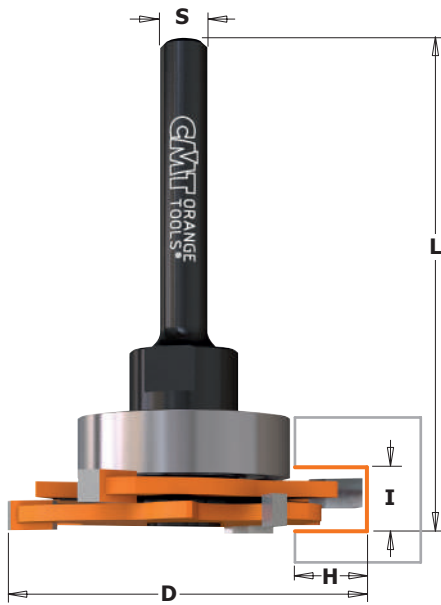

823.371

New CMT cutter for STRIPLOX® Mini connectors. These connectors are invisible joiners suited to everyday projects, custom cabinets, wood joints and any piece of cabinetry, furniture or design application. They produce a tight and strong joints either in a permanent or temporary structures making them perfectly suited for commercial, domestic and architectural furniture, kitchen, bathroom and wardrobe closets, cabinetry, commercial fit-outs plus many more applications.

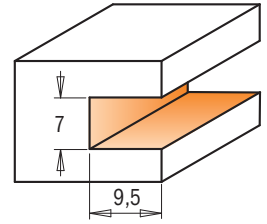

Drawing is 1:1 scale



I mm	D mm	H mm	L mm		ORDER NO. S=Ø6,35mm
7	47,6	9,5	65	10	823.371.11A

Spare parts

791.030.00	823.340.11	990.055.00	991.067.00

Spare parts: **541.515.00** 0,1mm spacer
541.516.00 0,3mm spacer
541.517.00 0,5mm spacer

Solid Surface - Counter-Top Trim Router Bits

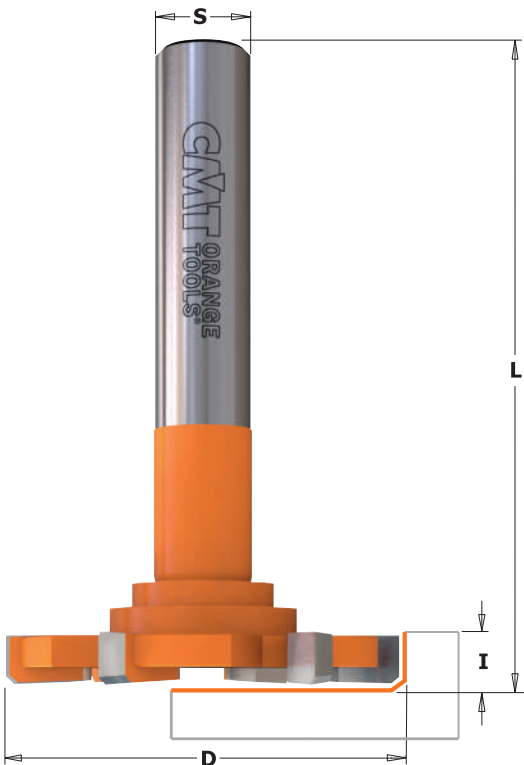

822/922.034.11

8/922.034-35

Create even shallow recesses in countertops with this 6-wing tool. The radiused cutting tips produce an edge that's super smooth to the touch and simple to clean. For use with handheld routers.

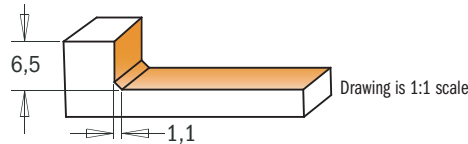

Drawing is 1:1 scale

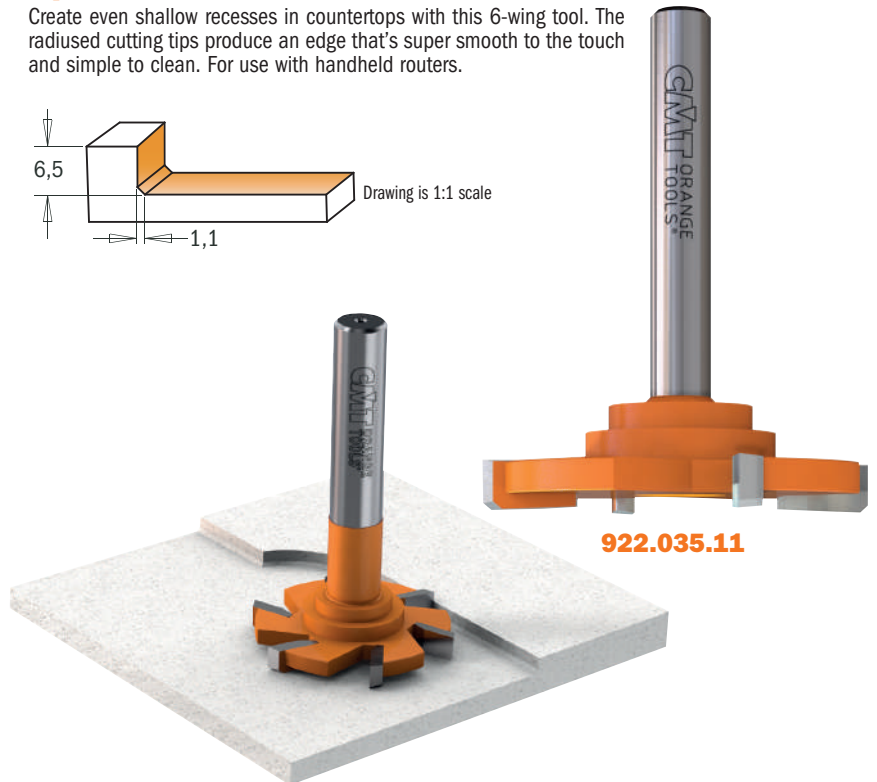

922.035.11

D mm	I mm	L mm	Z		ORDER NO. S=Ø8mm	ORDER NO. S=Ø12mm	ORDER NO. S=Ø12,7mm
52	6,5	65	4	5	922.035.11		
52	6,5	83,5	6	5		922.034.11	822.034.11

Solid Surface - Rounding Over Bits



7/8/938 - 8/980.5

Use these bits to create traditional roundover edges on solid surface countertops. Equipped with a non-marring DELRIN® bearing to protect finished edges. For use on hand-held portable routers.

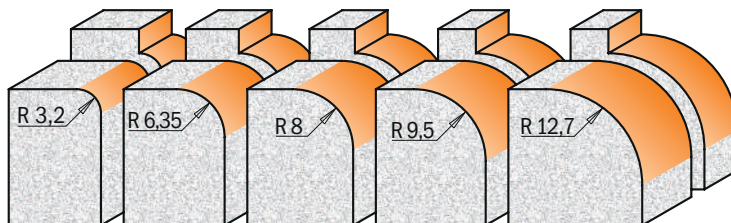
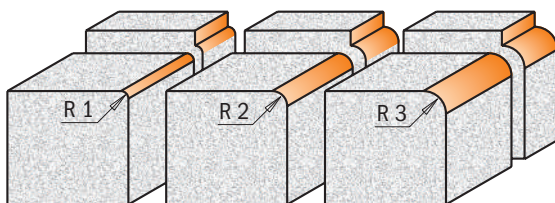
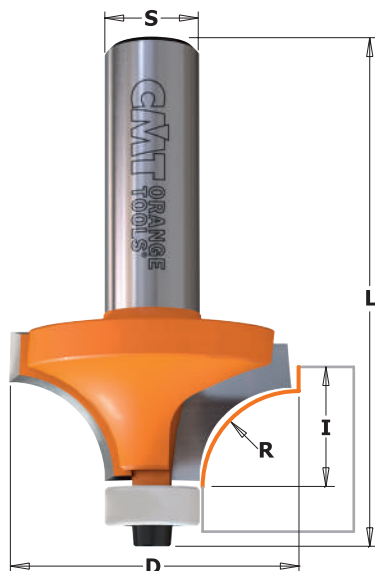

Drawing is 1:1 scale

APPLICATION
 WILSONART®
 GIBRALTAR®
 CORIAN®
 SURELL®
 FOUNTAINHEAD®
 AVONITE®
 FORMICA®
 Etc.

R mm	D mm	I mm	L mm		ORDER NO. S=Ø6mm	ORDER NO. S=Ø6,35mm	ORDER NO. S=Ø8mm	ORDER NO. S=Ø12mm	ORDER NO. S=Ø12,7mm
1	14,7	10	51	10		838.147.11	938.147.11		
2	16,7	12,7	52,5	10	738.167.11		938.167.11		
3	18,7	12,7	54	10	738.187.11		938.187.11		
3,2	19,05	12,7	59,5	10				980.501.11	880.501.11
6,35	25,4	12,7	59,5	10				980.502.11	880.502.11
8	28,7	15	62,5	10				980.505.11	880.505.11
9,5	31,75	14	61	10				980.503.11	880.503.11
12,7	38,1	19,05	66	10				980.504.11	880.504.11

Spare parts

990.422.00	791.044.00	990.058.00
990.422.00	791.044.00	990.058.00
990.422.00	791.044.00	990.058.00
990.422.00	791.044.00	990.058.00
990.422.00	791.044.00	990.058.00
990.422.00	791.044.00	990.058.00
990.422.00	791.044.00	990.058.00
990.422.00	791.044.00	990.058.00

Spare parts: **991.057.00** 3/32" hex key

Solid Surface - Decorative Edge Profile Bits



8/980.521

Create elegant countertops with flawless results. Features a non-marring DELRIN® bearing to protect the finished edges. For use on hand-held portable routers.

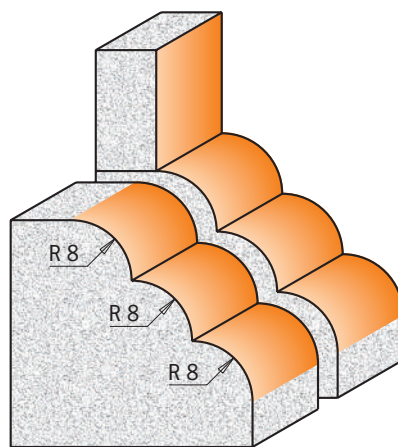
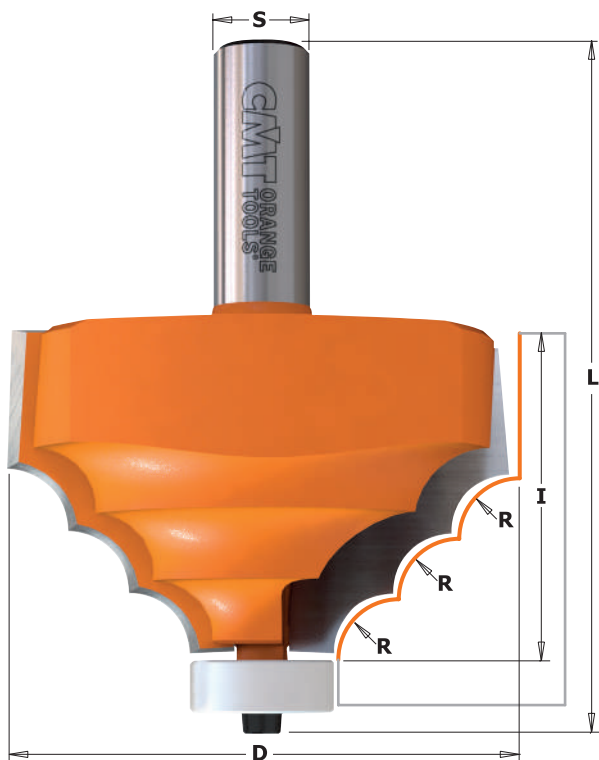

Drawing is 1:1 scale

APPLICATION
 WILSONART®
 GIBRALTAR®
 CORIAN®
 SURELL®
 FOUNTAINHEAD®
 AVONITE®
 FORMICA®
 Etc.

D mm	I mm	R mm	L mm		ORDER NO. S=Ø12mm	ORDER NO. S=Ø12,7mm
66,7	41,3	8	89,8	5	980.521.11	880.521.11

Spare parts

791.046.00	990.058.00	991.057.00

Solid Surface - Rounding Over Bowl Bits

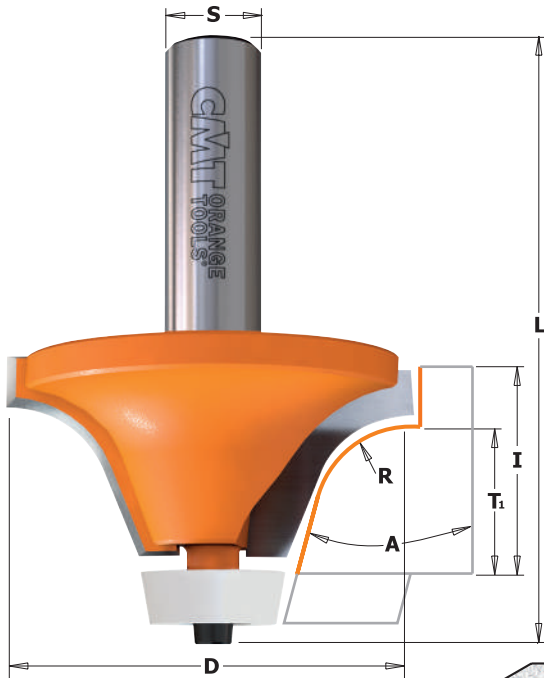

8/966.601/602
8/980.541



These bits are the best tool for rounding over and trimming countertop edges after the bowl is mounted. Can be used together with the CMT **8/980.551.11** bevel cutter for a flush cut-out between the countertop and the installed undermount bowl. For use on hand-held routers. Features a non-marring DELRIN® bearing to protect the finished edges as well as surfaces.

APPLICATION
WILSONART®
GIBRALTAR®
CORIAN®
SURELL®
FOUNTAINHEAD®
AVONITE®
FORMICA®
Etc.

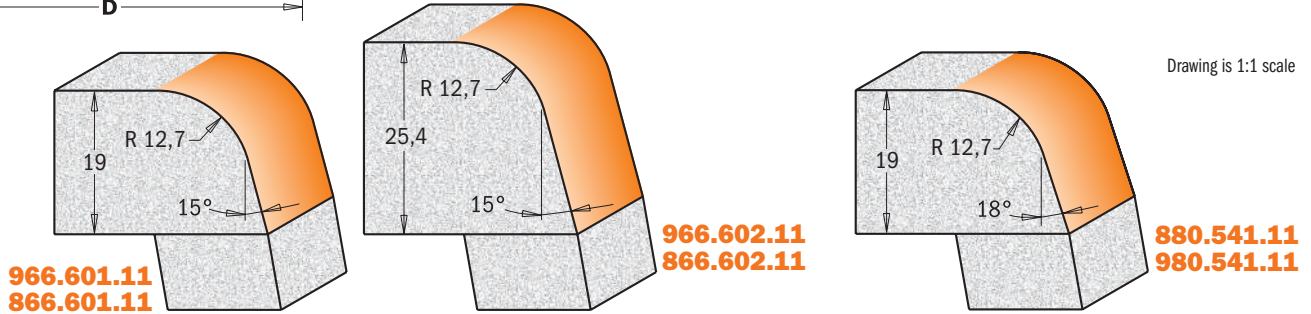

966.601.11
866.601.11

966.602.11
866.602.11

880.541.11
980.541.11

A	D mm	T ₁ mm	I mm	R mm	L mm		ORDER NO. S=Ø12mm	ORDER NO. S=Ø12,7mm
15°	50,8	19	25,4	12,7	74,9	10	966.601.11	866.601.11
15°	50,8	25,4	31,75	12,7	81,3	10	966.602.11	866.602.11
18°	54	19	25,4	12,7	78,1	10	980.541.11	880.541.11

Spare parts

791.041.00	990.058.00	991.057.00
791.041.00	990.058.00	991.057.00
791.041.00	990.058.00	991.057.00

Solid Surface - Rounding Over Bowl Bit (ogee profile)

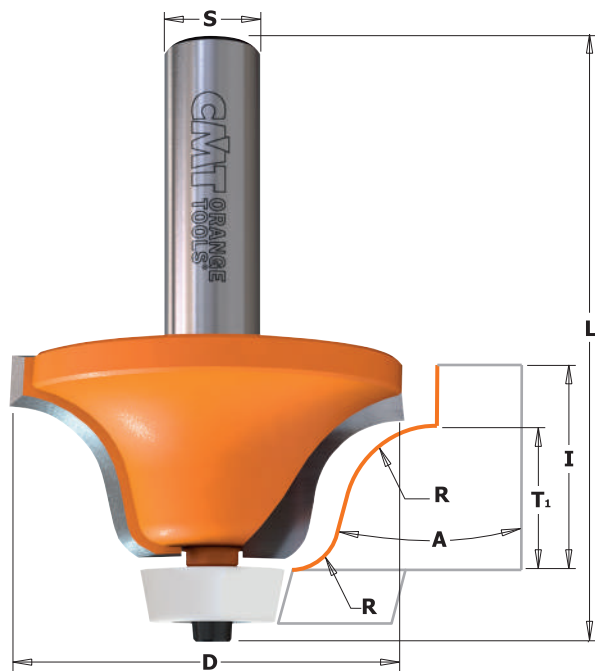

8/980.542



These bits roundover and trim the countertop edges after the bowl is mounted. Can be used with the CMT **8/980.551.11** bevel cutter for a flush cut-out between the countertop and installed undermount bowl.

For use on hand-held portable routers. Features a non-marring DELRIN® bearing to protect the finished edges.

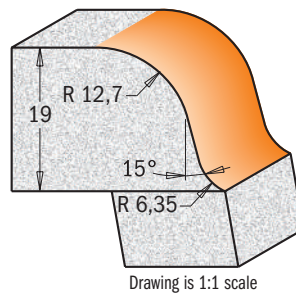

Drawing is 1:1 scale

APPLICATION
WILSONART®
GIBRALTAR®
CORIAN®
SURELL®
FOUNTAINHEAD®
AVONITE®
FORMICA®
Etc.

A	D mm	T ₁ mm	I mm	R mm	L mm		ORDER NO. S=Ø12mm	ORDER NO. S=Ø12,7mm
15°	54	19	25,4	6,35-12,7	77,6	10	980.542.11	880.542.11

Spare parts

791.041.00	990.058.00	991.057.00

Solid Surface - Bevel Bowl Bits

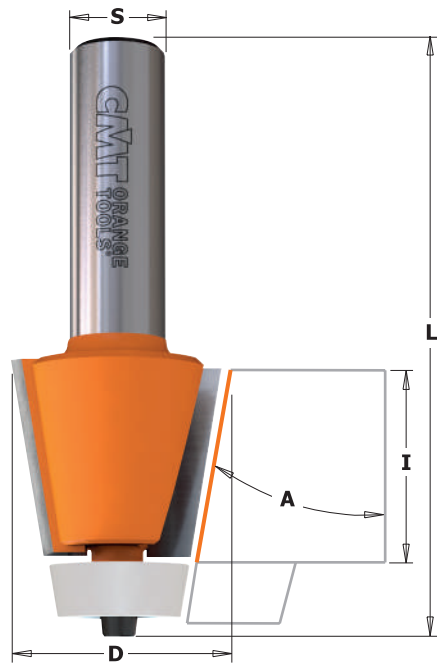

8/966.501 - 8/980.551



These bits are designed for undermount applications joining the countertops and sink bowls with a beveled edge. Can be used with the 8/980.541.11 and 8/980.542.11 for complete undermount applications. For use on hand-held routers. Features a non-marring DELRIN® bearing to protect the finished edges and surfaces.

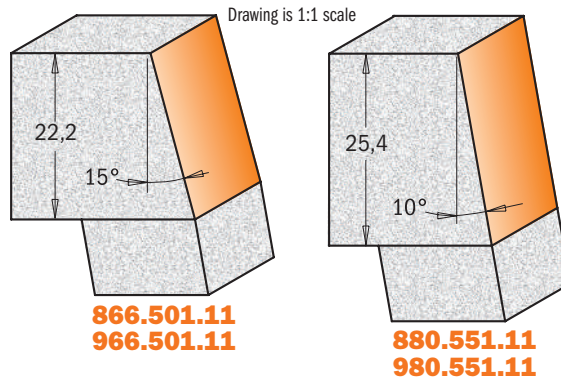

APPLICATION
 WILSONART®
 GIBRALTAR®
 CORIAN®
 SURELL®
 FOUNTAINHEAD®
 AVONITE®
 FORMICA®
 Etc.

A	D mm	I mm	L mm		ORDER NO. S=∅12mm	ORDER NO. S=∅12,7mm
15°	31,7	22,2	72	10	966.501.11	866.501.11
10°	28,5	25,4	77	10	980.551.11	880.551.11

Spare parts

791.041.00	990.058.00	991.057.00
791.041.00	990.058.00	991.057.00

Solid Surface - Bevel Bit

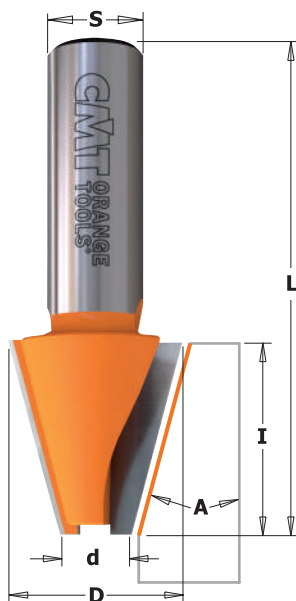

8/981.521



Edge profile bit designed to create a 15° beveled edge on solid surface countertops. Can also be used for European type topmount installation with sinks and bowls. For use on hand-held portable and table routers.

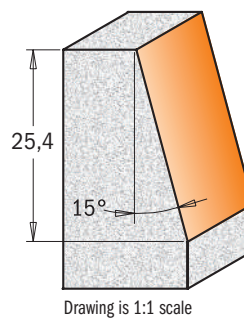

APPLICATION
 WILSONART®
 GIBRALTAR®
 CORIAN®
 SURELL®
 FOUNTAINHEAD®
 AVONITE®
 FORMICA®
 Etc.

D mm	d mm	I mm	A	L mm		ORDER NO. S=∅12mm	ORDER NO. S=∅12,7mm
23	9,52	25,4	15°	63,5	10	981.521.11	881.521.11

Solid Surface - Cut & Plug Repair Set



Download the instructions

9/881.541



These special carbide-tipped bits work best on solid surfaces or when repairing damaged surfaces. One bit creates the plug, then the other bit easily carves out the hole. Your surfaces will look like new again!
For use with hand-held routers or CNC machines.

APPLICATION

WILSONART®
GIBALTAR®
CORIAN®
SURELL®
FOUNTAINHEAD®
AVONITE®
FORMICA®
Etc.

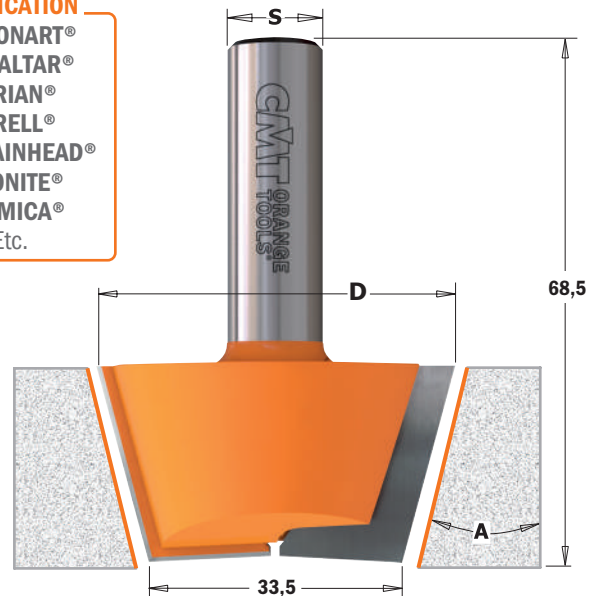
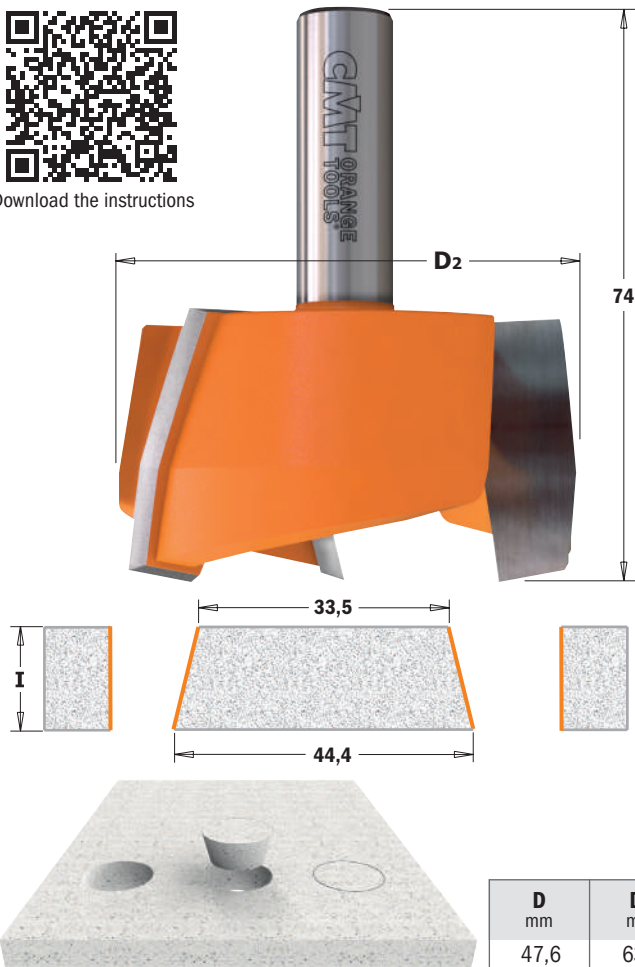

D mm	D2 mm	I mm	A	L mm		ORDER NO. S=Ø12mm	ORDER NO. S=Ø12,7mm
47,6	63,5	20	15°	68,5-74	5	981.541.11	881.541.11

4-Wing Cut Out Slot Cutters for Solid Surfaces



8/922.033B

This bit features two tungsten carbide-tipped cutting edges for carving out solid surface undermount bowls in composite. For use on hand-held routers. Bit also equipped with a non-marring DELRIN® bearing to protect your surfaces.

APPLICATION

WILSONART®
GIBALTAR®
CORIAN®
SURELL®
FOUNTAINHEAD®
AVONITE®
FORMICA®
Etc.

Drawing is 1:1 scale

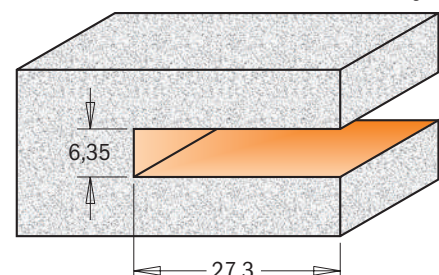
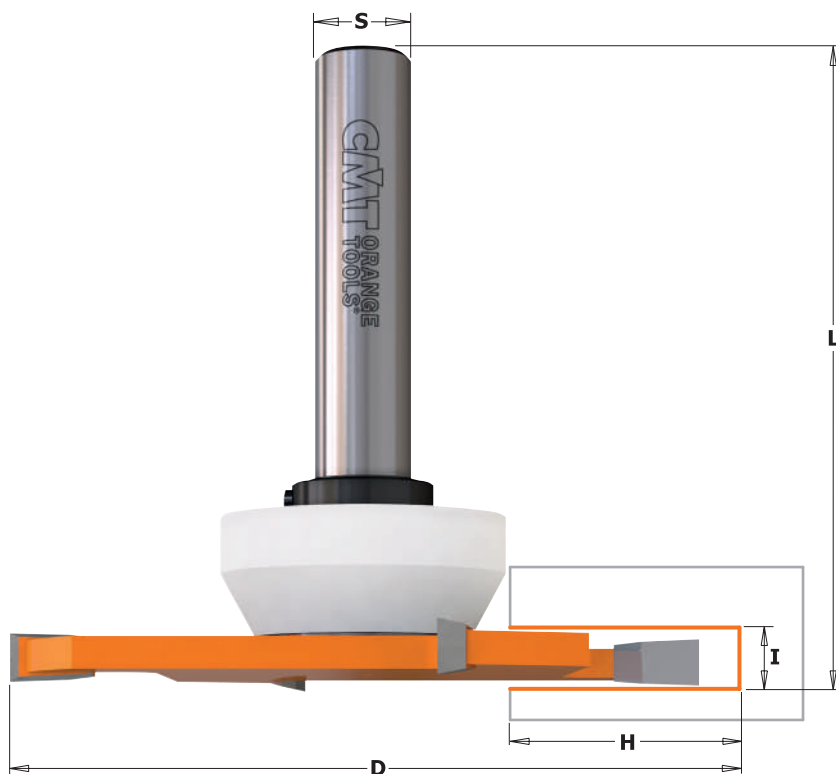

D mm	I mm	H mm	L mm		ORDER NO. S=Ø12mm	ORDER NO. S=Ø12,7mm
92	6,35	27,3	82,5	5	922.033.11B	822.033.11B

Spare parts

541.553.00	791.047.00	541.002.00	991.056.00

Solid Surface - No-Drip Bit



8/981.501

This bit is designed to create "no-drip" edges on kitchen and vanity countertops in one simple step. Designed for hand-held portable routers on applications where a guide bearing cannot be used. This one bit will cut both the outer and inner profiles creating a slightly raised edge, controlling spilled liquids.

APPLICATION

- WILSONART®
- GIBRALTAR®
- CORIAN®
- SURELL®
- FOUNTAINHEAD®
- AVONITE®
- FORMICA®
- Etc.

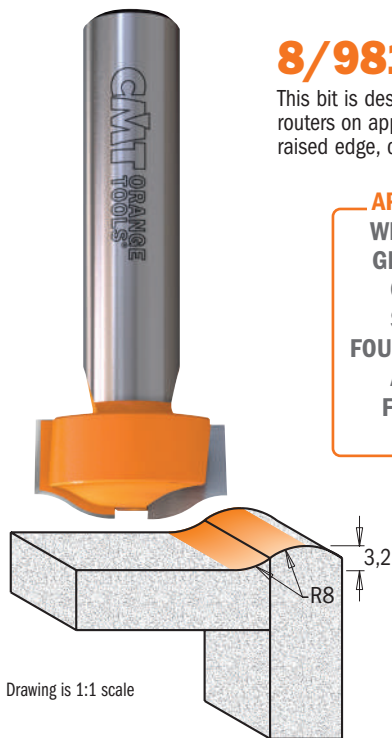
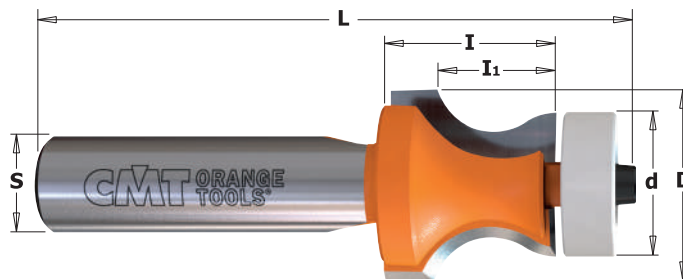

Drawing is 1:1 scale

8/980.531

This bit creates strong and reliable joints in a variety of composites thanks to greater surface area for applying glue.

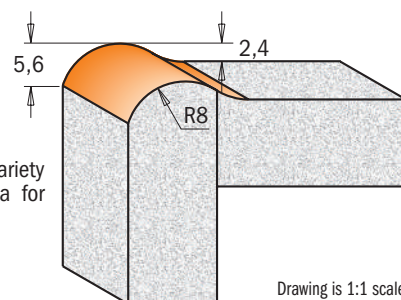

Drawing is 1:1 scale

D mm	d mm	I mm	I ₁ mm	R mm	L mm		ORDER NO. S=Ø12mm	ORDER NO. S=Ø12,7mm
25,4		12,7	3,2	8	63,5	10	981.501.11	881.501.11
25,4	19	22,2	15,87	8	77	10	980.531.11	880.531.11

Spare parts

791.046.00	990.058.00	991.057.00

Solid Surface - Wavy Joint Bit

8/981.531

These bits are ideal for making strong joints on any solid surface, thanks to a wider surface area for glue application.



APPLICATION

- WILSONART®
- GIBRALTAR®
- CORIAN®
- SURELL®
- FOUNTAINHEAD®
- AVONITE®
- FORMICA®
- Etc.

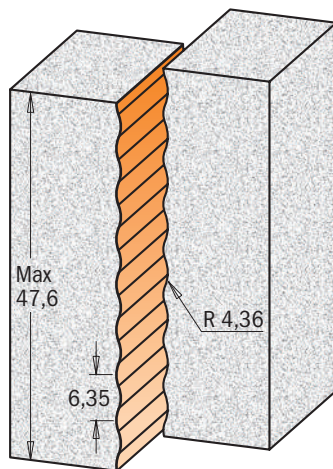
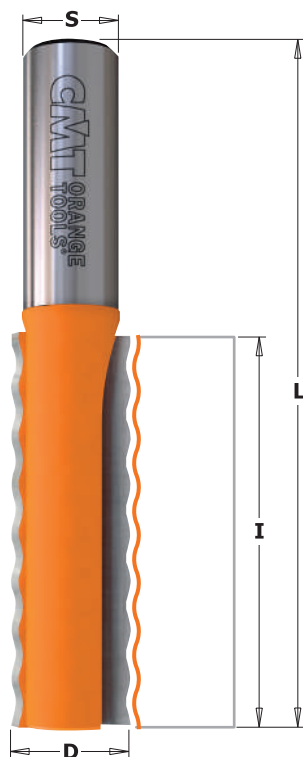

Drawing is 1:1 scale

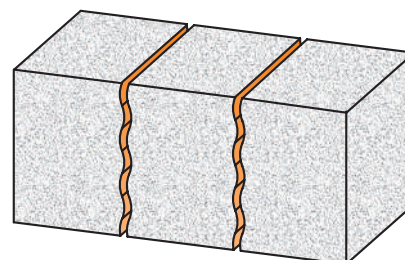

D mm	I mm	R mm	L mm		ORDER NO. S=Ø12mm	ORDER NO. S=Ø12,7mm
15,87	51,5	4,36	89	10	981.531.11	881.531.11

Solid Surface - Drainboard Bits

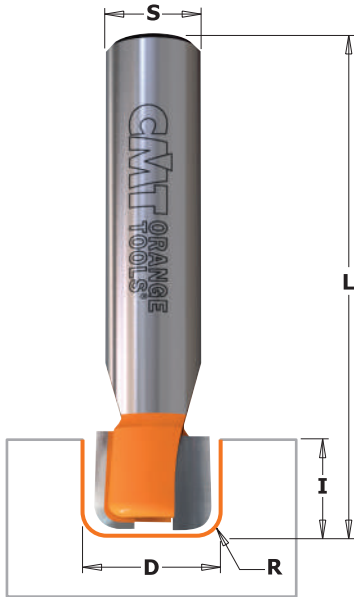

8/981.511-512

This bit is ideal for creating custom drainboard patterns in solid surface countertops. For use on hand-held portable routers.



APPLICATION

WILSONART®
GIBRALTAR®
CORIAN®
SURELL®
FOUNTAINHEAD®
AVONITE®
FORMICA®
Etc.

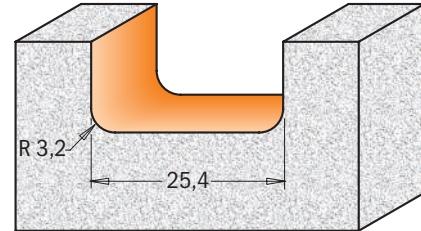
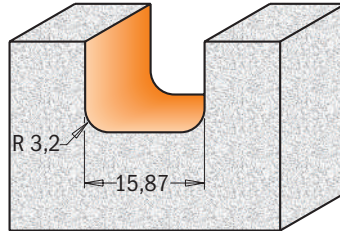

Drawing is 1:1 scale

D mm	I mm	R mm	L mm				ORDER NO. S=Ø12mm	ORDER NO. S=Ø12,7mm
15,87	12,7	3,2	63,5	10			981.511.11	881.511.11
25,4	12,7	3,2	69,8	10			981.512.11	881.512.11

Solid Surface - Inlay Bits

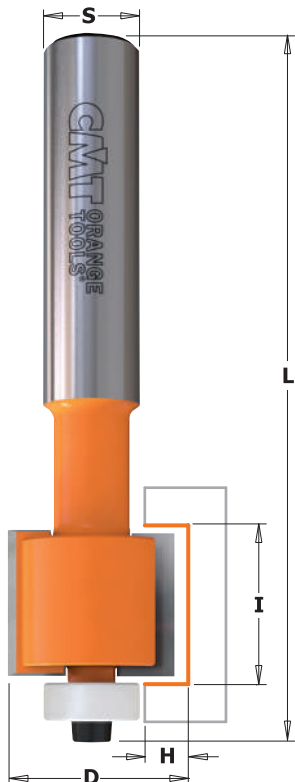

8/980.511-512-513

Add a decorative inlay to solid surface countertops in composite. Equipped with a non-marring DELRIN® bearing to protect the finished edges. For use on hand-held portable and table routers.



APPLICATION

WILSONART®
GIBRALTAR®
CORIAN®
SURELL®
FOUNTAINHEAD®
AVONITE®
FORMICA®
Etc.

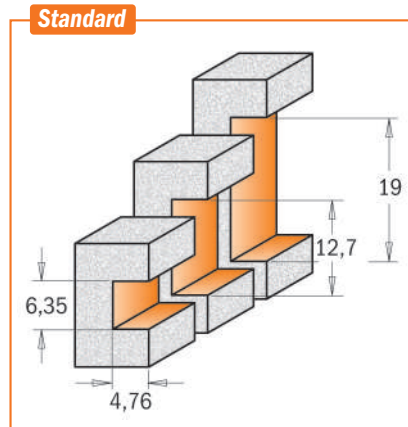

Drawing is 1:1 scale

Optional

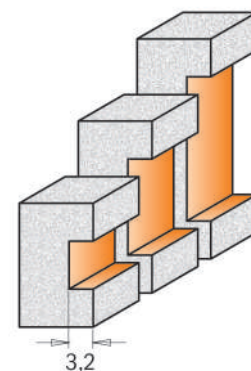

optional with bearing **791.045.00**

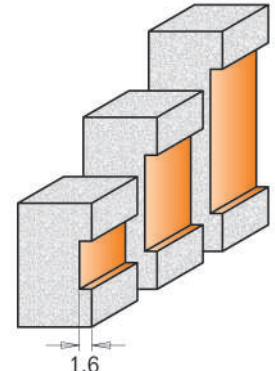

optional with bearing **791.046.00**

D mm	I mm	H mm	L mm		ORDER NO. S=Ø12mm	ORDER NO. S=Ø12,7mm	Spare parts		
22,2	6,35	4,76	77	10	980.511.11	880.511.11			
22,2	12,7	4,76	90	10	980.512.11	880.512.11	791.044.00	990.058.00	991.057.00
22,2	19,05	4,76	90	10	980.513.11	880.513.11	791.044.00	990.058.00	991.057.00

Solid Surface - Sink & Trim Bits



8/980.57

Trim a sink cut-out flush with the bowl in stages using these "over-hang" and flush trim bits. The DELRIN® bearings are tapered to match the slope of the bowl's side. A first pass with the over-hang bit cleans the cut-out edge, leaving a slight over-hang on the underside of the counter. A second pass with the flush-trim bit completes the operation. Made from super micrograin carbide for guaranteed longer life!

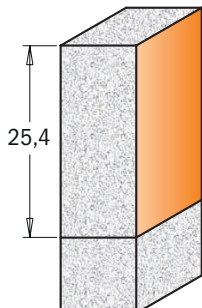

880.571.11
980.571.11

Drawing is 1:1 scale

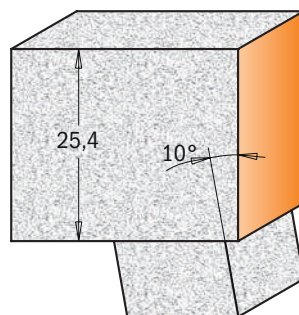

880.572.11
980.572.11



APPLICATION

WILSONART®
GIBRALTAR®
CORIAN®
SURELL®
FOUNTAINHEAD®
AVONITE®
FORMICA®
Etc.



D mm	I mm	A	L mm		ORDER NO. S=Ø12mm	ORDER NO. S=Ø12,7mm
19,05	25,4		78	10	980.571.11	880.571.11
22	25,4	10°	78	10	980.572.11	880.572.11

Spare parts

791.046.00	990.058.00	991.057.00
791.048.00	990.058.00	991.057.00

Solid Surface - Sink & Trim Bits with Insert Knives



8/980.56

Trim a sink cut-out flush with the bowl in stages using these "over-hang" and flush trim bits. The DELRIN® bearings are tapered to match the slope of the bowl's side. A first pass with the overhang bit **8/980.562.11** cleans the cut-out edge, leaving a slight overhang on the underside of the counter. A second pass with the flush-trim bit **8/980.561.11** completes the operation. Knives made from super micrograin carbide and sharpened on both sides guarantee longer life!

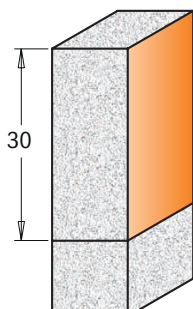

880.561.11
980.561.11

Drawing is 1:1 scale

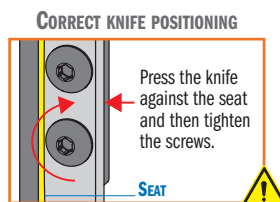

APPLICATION

WILSONART®
GIBRALTAR®
CORIAN®
SURELL®
FOUNTAINHEAD®
AVONITE®
FORMICA®
Etc.



880.562.11
980.562.11

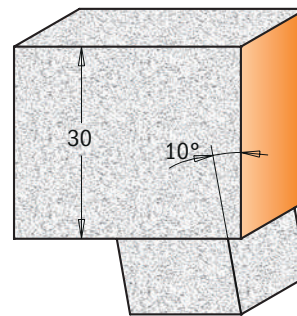

Drawing is 1:1 scale

SAFETY TIPS:



The **TW-006** Torque Screwdriver is recommended for the proper fastening of screws (see page 406).

D mm	I mm	A	L mm		ORDER NO. S=Ø12mm	ORDER NO. S=Ø12,7mm
19,05	30		83	10	980.561.11	880.561.11
22	30	10°	83	10	980.562.11	880.562.11

Spare parts

790.300.03	990.075.00	991.061.00	791.046.00	990.058.00
790.300.03	990.075.00	991.061.00	791.048.00	990.058.00

26-Piece Router Bit Sets



900.003

Find a whole workshop in this practical 26-piece router bit set! An endless selection of tools to express your woodworking creativity! Every cutting tool is made from the highest quality tungsten carbide and features our trademarked P.T.F.E. orange coating. Comes with a snap-lock case for safe storage!



DESCRIPTION	Box	ORDER NO. S=Ø8mm
26-Piece Router Bit Sets	1	900.003.00

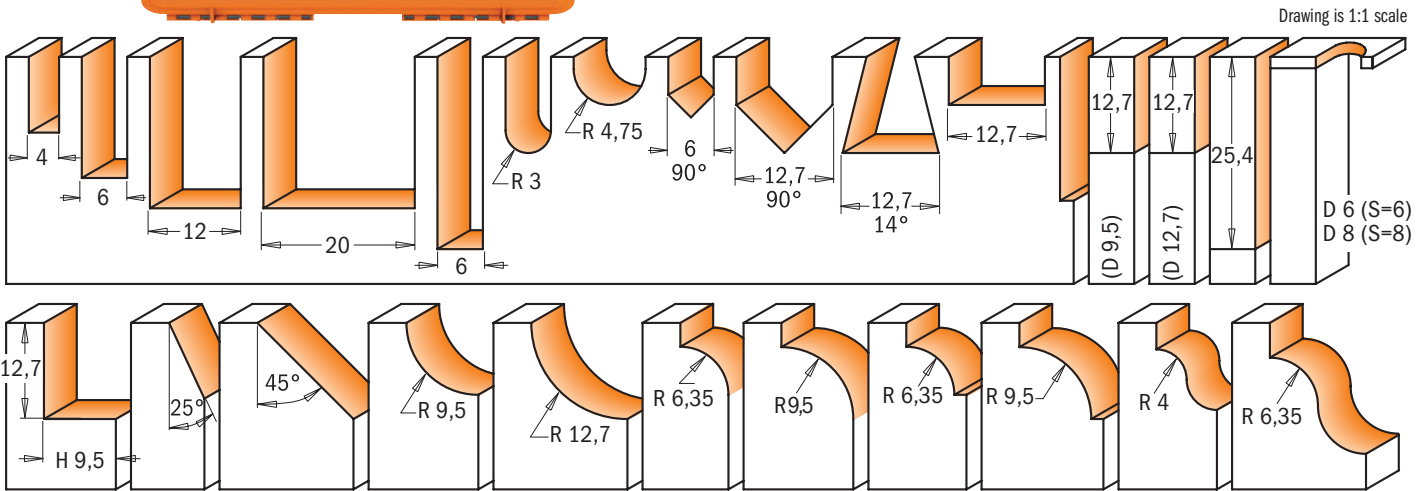

15-Piece Router Bit Sets



8/900.001

CMT's 15 piece bit router bit set is the perfect companion for the professional craftsman. This set offers a selection of organized and ready-to-use straight and profile bits. Added value for any woodworker! Each bit is made with micrograin tungsten carbide and coated with orange non-stick P.T.F.E. Comes with a snap-lock case for safe storage!



DESCRIPTION	Box	ORDER NO. S=Ø6,35mm	ORDER NO. S=Ø8mm
15-Piece Router Bit Sets	1	800.001.00	900.001.00

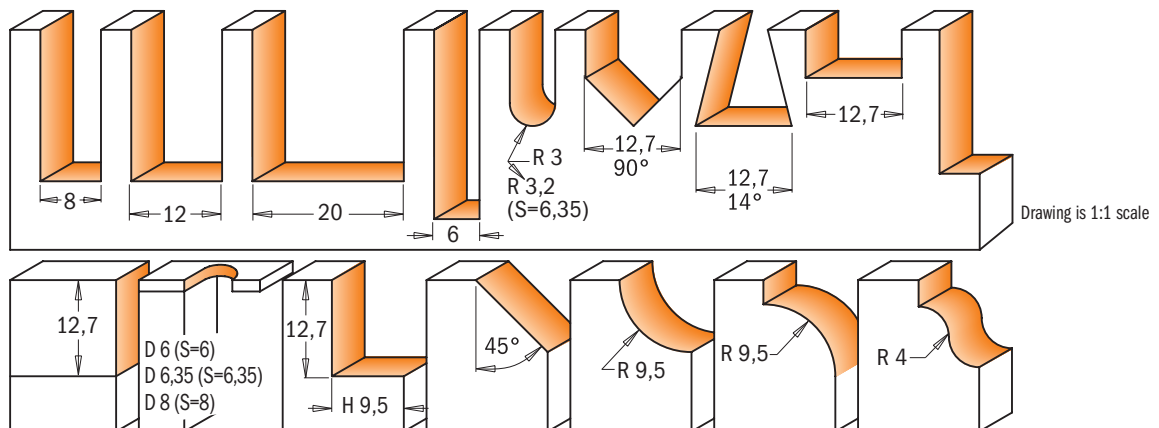

12-Piece Router Bit Sets



800.503

CMT's 12 most frequently used 6.35mm shank router bits assembled in a compact and attractive case for your convenience! The perfect case for any professional woodworker! Comes with a snap-lock case for safe storage!



DESCRIPTION		ORDER NO.
12-Piece Router Bit Sets	1	S=Ø6,35mm 800.503.11

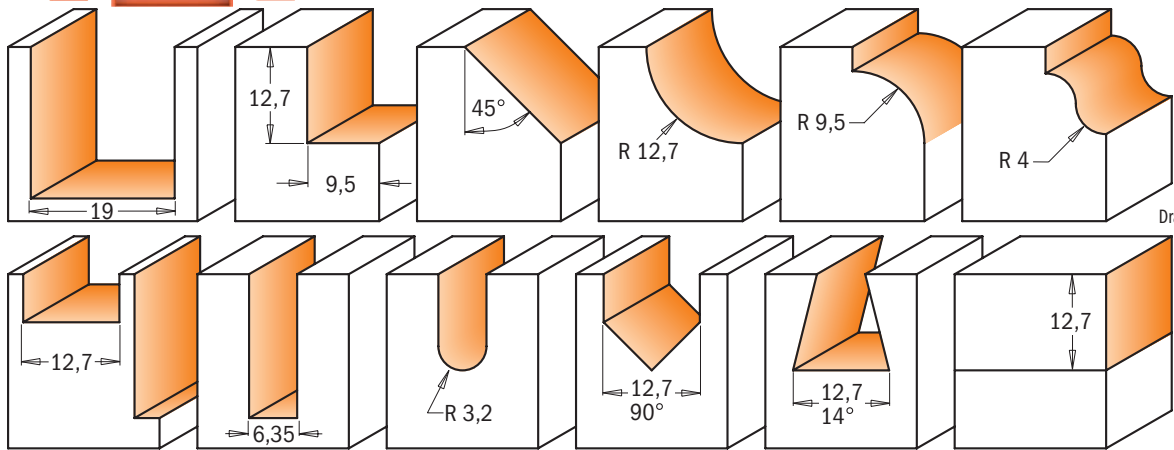

Drawing is 1:1 scale

13-Piece Router Bit Sets



800.505

CMT's 13 most frequently used 12.7mm shank router bits assembled in a compact and attractive case for your convenience! Unique design that comes with a snap-lock case for safe storage!



DESCRIPTION		ORDER NO.
13-Piece Router Bit Sets	1	S=Ø12,7mm 800.505.11

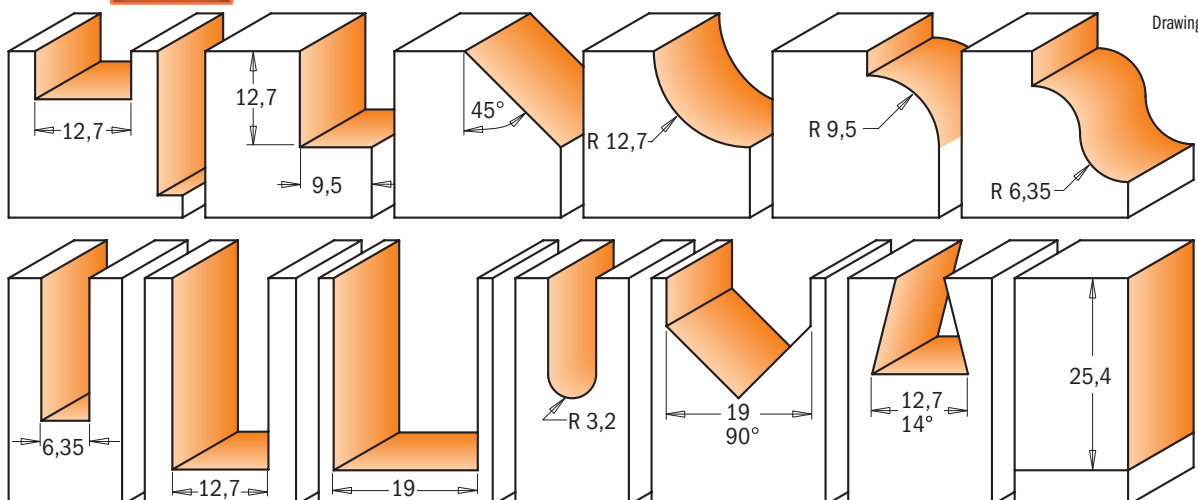

Drawing is 1:1 scale

Divided Light Door Sets





800.525 - 900.025

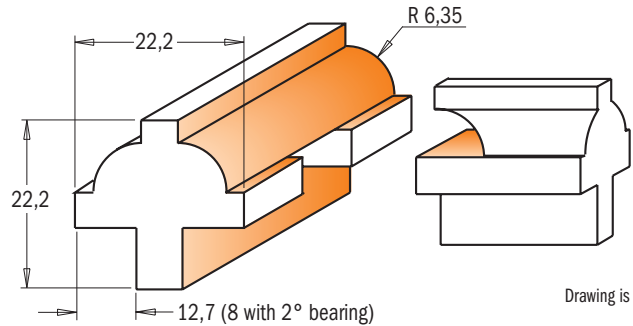
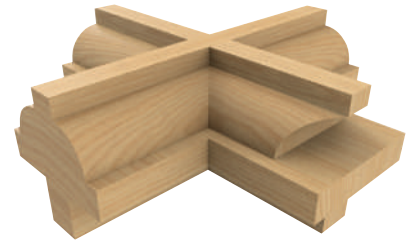

Build authentic divided light doors for fine furniture and cabinets with these 3-piece sets. They include a stuck bit to cut the decorative ovolo profile on the frame edges, a cope to shape the mating profile on the ends of the stock, and a rabbeting bit to cut the recess for the glass. Thanks to the guide bearings, you can also create arches on curved frames. The unique design of the cope bit allows you to use full-length tenons to create strong, authentic mortise-and-tenon joinery.

As the stock is coped, the tenon passes over the bit. These sets are designed for 22,2mm wide bars such as those on corner cupboard doors.



DESCRIPTION		ORDER NO. S=Ø8mm	ORDER NO. S=Ø12,7mm
Divided Light Door Sets	1	900.025.11	800.525.11

Glass Panel Sets



8/955.803



CMT's unique stile and rail router bit sets allow you to produce glass panel doors by using a rubber panel retainer to secure the glass in a 3,2mm slot cut into the frames. These bits work the same as other CMT stile and rail sets, but they leave you with a square rabbet on the inside of your door for installing the glass panel.

Available in 12mm and 12,7mm shanks.

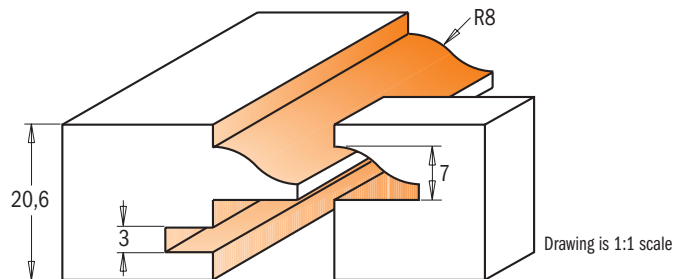

DESCRIPTION		ORDER NO. S=Ø12mm	ORDER NO. S=Ø12,7mm
Glass Panel Sets	1	955.803.11	855.803.11

Optional: GLAS/RTBRN Glass panel retainers 762cm.

GLASS PANEL RETAINERS

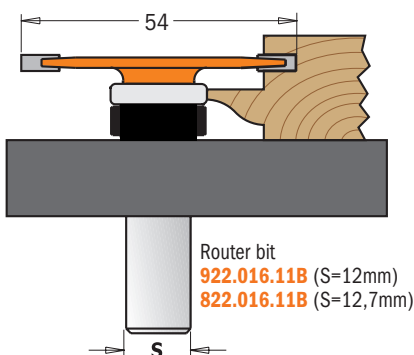

HERE'S HOW IT WORKS:

Mill the cope and pattern cuts first, then use the slot cutter to cut the groove for the rubber panel retainer. The edge of the pattern cut will ride on the bearing of the slot cutter bit. When you cut the slot in the rails you can cut the slot the full length of the stock. When you cut the slot in the stiles you need to set up reference points to stop and start the cuts so they are hidden from view on the top and bottom of the doors.

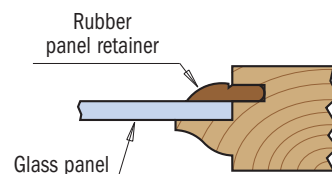

GLAS/RTBRN



Our unique retainer strips fit perfectly in the slots created by the slot cutter bit and hold your glass securely in the frame. Sold in 762cm lengths.

Entry & Interior Door Router Bit Set



8/900.527

This is a multifunctional set for door and furniture makers, building entry or passage doors and furniture tenons. The tenon cutter included in the set, produces a beefy 27mm long tenon. As an extra bonus, the tenon cutter can be used for making furniture requiring tenons anywhere from 9.5mm to 16mm in thickness.



Entry & interior door construction
Easy as 1, 2, 3!

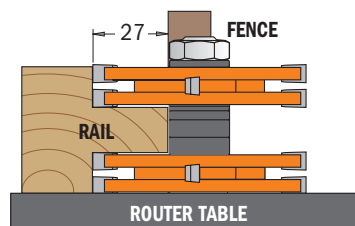

Step 1. Cut the tenon into the rails

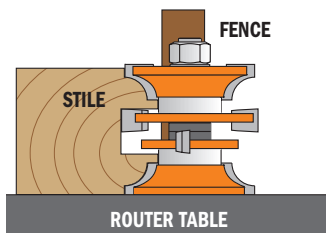

Step 2. Cut the groove and door profile in pieces.

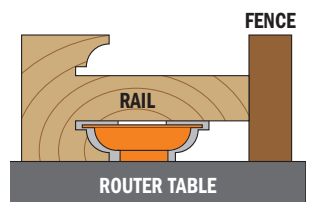

Step 3. Undercut the tenons to cope the ends of the rails.

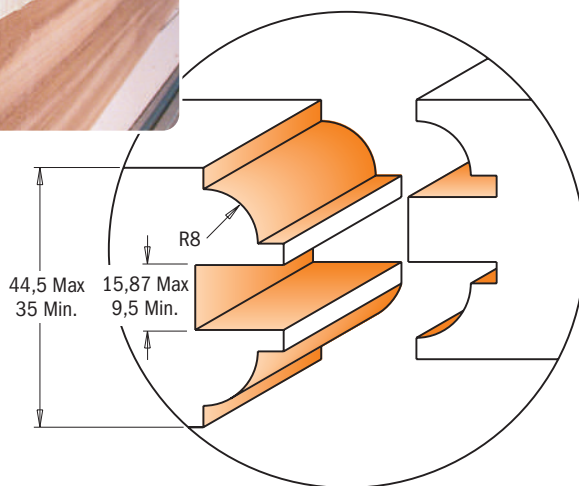

DESCRIPTION	ORDER NO.	ORDER NO.
3-Piece Entry & Interior Door Router Bit Set	S=Ø12mm 900.527.11	S=Ø12,7mm 800.527.11

2-Piece Entry Door Router Bit Set

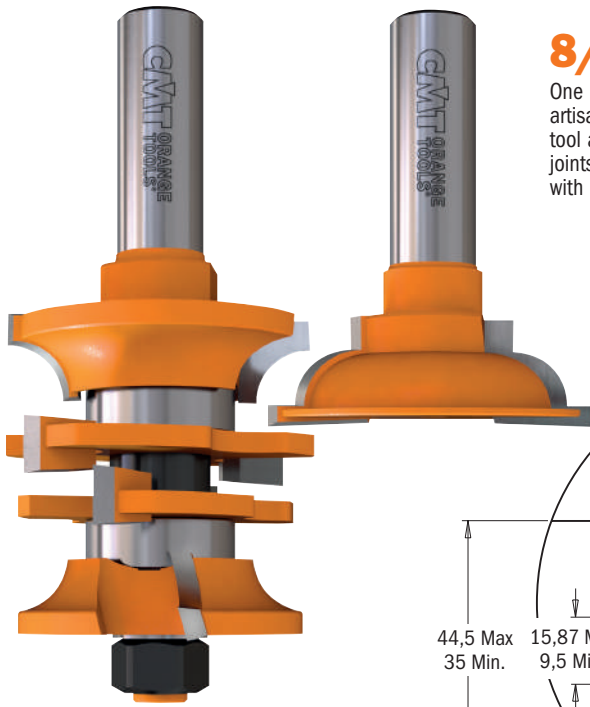

8/955.806

One of the more popular bits among both artisans and professional carpenters, this tool allows you to create tongue and-groove joints and produce entry and passage doors with minimal effort. Incredible versatility!



Entry & Interior Door Construction

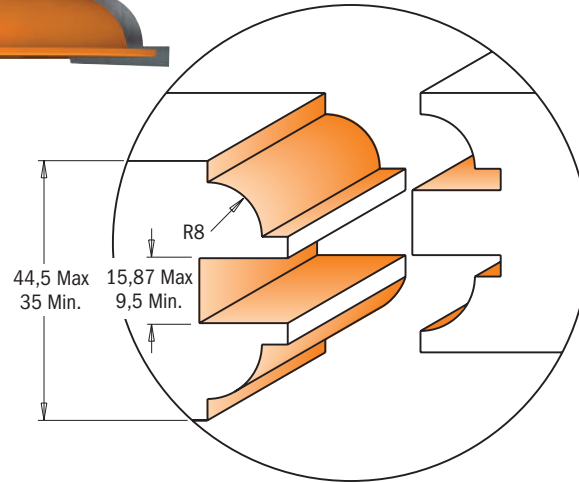
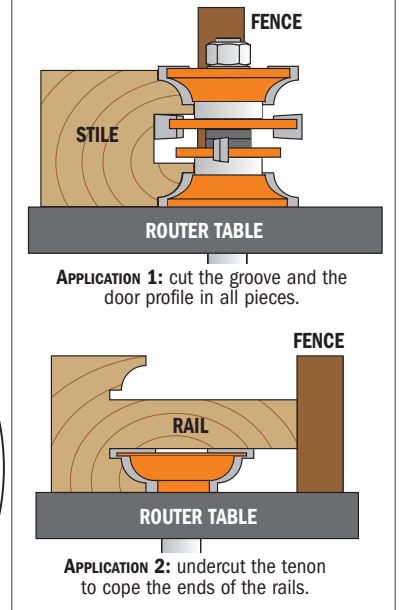

D mm	I mm	Box	ORDER NO. S=Ø12mm	ORDER NO. S=Ø12,7mm	Spare parts								
44,5-48	35-44,5	5	955.806.11	855.806.11	8-22mm	up	down			0,1mm	0,3mm	3mm	
					791.005.00	822.021.11A	822.021.11B	822.022.11		541.515.00	541.516.00	541.500.00	990.020.00

Tenon Cutting Router Bits

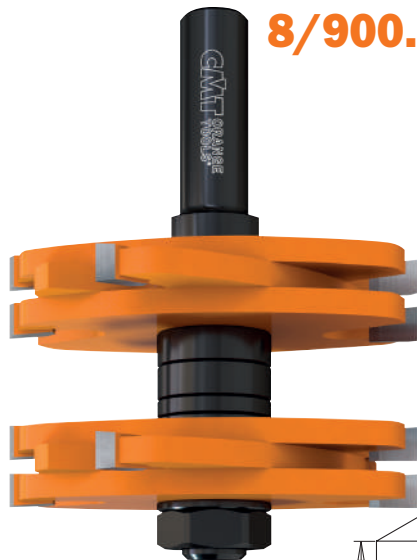

8/900.628



8/900.627



CMT's tenon cutting router bit will produce the most perfect fitting tenons in every board you cut, even if the boards vary in thickness. Simply set the distance between the cutters using the included spacers, and you can easily cut tenons from 4,76mm to 9,5mm thick, and up to 27mm long. This simple-to-use router bit takes the mystery out of tenon-to-mortise fit required for high quality joinery.

Maximum speed
MAX RPM 12.000

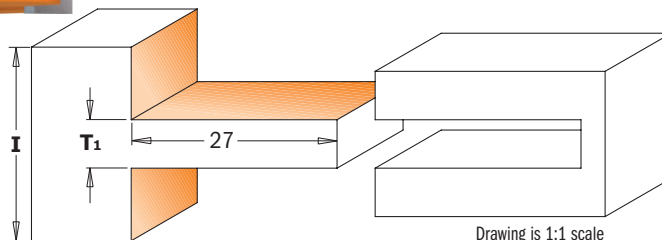

8-900.627

T1	Spacer (mm)		
	6,35mm	3,2mm	1,6mm
4,76mm	1	0	0
6,35mm	1	0	1
8mm	1	1	0
9,5mm	1	1	1

D mm	I mm	T1 mm	Box	ORDER NO. S=Ø12mm	ORDER NO. S=Ø12,7mm	Spare parts									
75	34,9	4,76-9,5	5	900.627.11						0,1mm	0,3mm	1,6mm	3,2mm	6,2mm	
75	34,9	4,76-9,5	5		800.627.11	924.134.00	822.020.11	541.513.00	541.520.00	541.521.00	541.522.00	541.523.00	990.022.00		
75	44,5	9,5-15,8	5	900.628.11		824.134.00	822.020.11	541.513.00	541.520.00	541.521.00	541.522.00	541.523.00	990.022.00		
75	44,5	9,5-15,8	5		800.628.11	924.135.00	822.020.11	541.513.00	541.520.00	541.521.00	541.522.00	541.523.00	990.022.00		
						824.135.00	822.020.11	541.513.00	541.520.00	541.521.00	541.522.00	541.523.00	990.022.00		

The Cabinetmaking Sets



Available with raised panel bits in two different profiles, these sets feature six router bits for making arched raised panel doors and professional drawer fronts. These sets include:

OGEE RAIL & STILE BITS: these two perfectly matched tools will eliminate the frustration of setting up reversible cutters. The stile bits also feature shear angles for neater cuts.

RAISED PANEL BIT WITH BACKCUTTER: this 88,9mm diameter bit features a backcutter for milling both the front and the back on the panel in a single cut. We recommend using a 31mm diameter bearing to work safely in two shallow passes.

SUPER-DUTY FLUSH TRIM BIT: this 19mm diameter bit gives you a superior cut with minimal chipping, even on end grain.

OGEE DOOR EDGE BIT: a subtle cove followed by a subtle roundover adds an elegant touch to your door edge.

DRAWER FRONT BIT: this bit makes a mini-raised panel cut on the outside edges of your drawer fronts.

DESCRIPTION		ORDER NO. S=Ø12,7mm
The Cabinetmaking Sets - Profile A (6 HW pcs.)	1	800.515.11
The Cabinetmaking Sets - Profile B (6 HW pcs.)	1	800.520.11

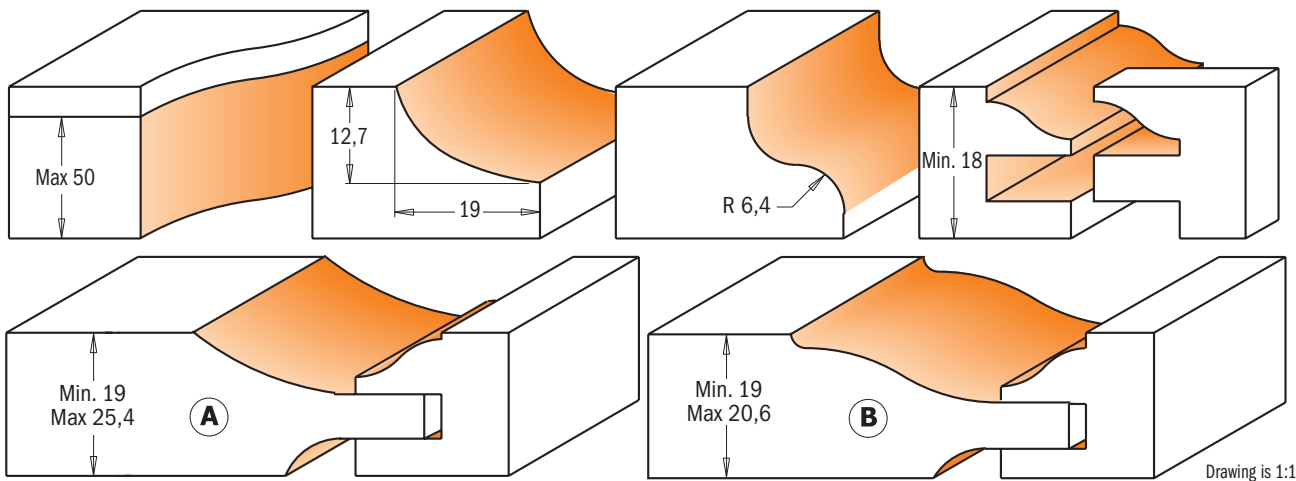

Drawing is 1:1 scale

Small Arch Door Sets



800.524 - 900.024



These 3-piece sets will produce beautifully raised panel doors with a classic beveled profile. Designed for use in fine furniture making, these sets include two matched cope and stick bits to produce frames from 15,87mm to 19mm in thickness. The stick bit shapes a decorative 4,76mm thumbnail moulding along the edge of the frame.

The panel bit is designed for material 12,7mm in thickness. All bits are equipped with guide bearings for shaping curved work such as the small arched panel doors seen on secretaries and corner cabinetry.

These sets also produce panels for small chests, lids for small boxes, or drawer fronts. Available in 8mm and 12,7mm shanks.

DESCRIPTION		ORDER NO. S=Ø8mm	ORDER NO. S=Ø12,7mm
Small Arch Door Sets (3 HW pcs.)	1	900.024.11	800.524.11

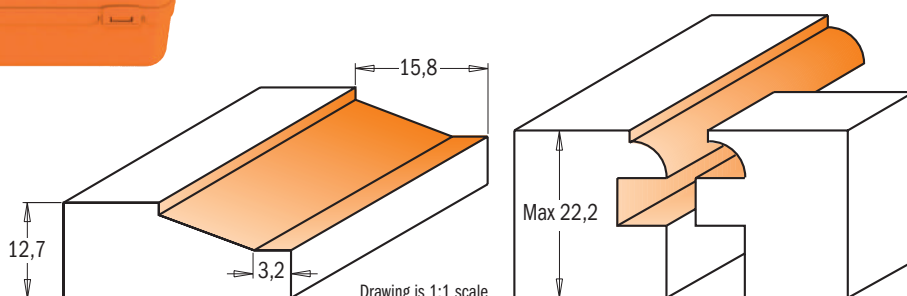

Drawing is 1:1 scale





These CMT's sets aren't only a random selection of odds and ends packaged in a handy carry case, but they are also professional kits for drawer and door makers. 3 sets to choose from, 5 different bits to suit your needs: a raised panel bit, rail and stile bits, a glue joint and a drawer lock bit. Please refer to the illustrations below for complete profile options.



DESCRIPTION	1	ORDER NO. S=Ø12mm	ORDER NO. S=Ø12,7mm
CMT's Complete Kitchen Set - Profile A (5 HW pcs.)	1	900.509.11	800.509.11
CMT's Complete Kitchen Set - Profile B (5 HW pcs.)	1	900.510.11	800.510.11
CMT's Complete Kitchen Set - Profile C (5 HW pcs.)	1	900.511.11	800.511.11

8/900.509.11

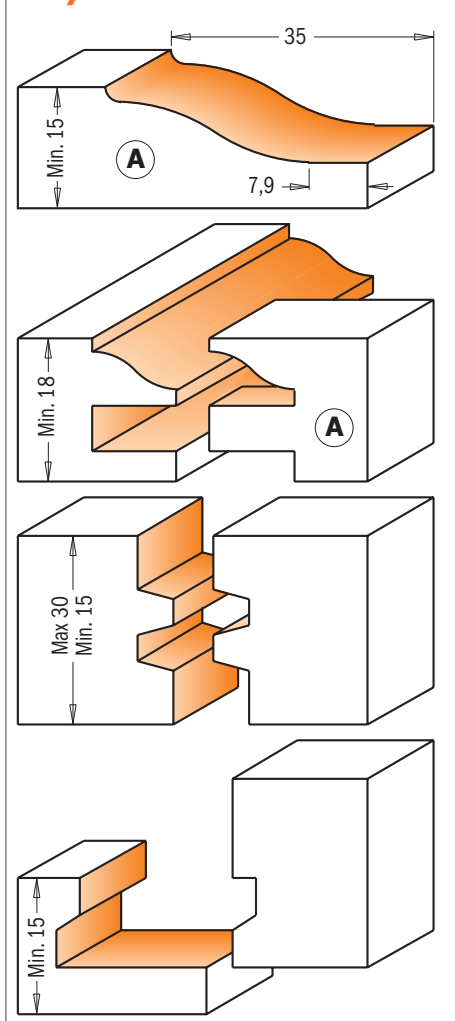

8/900.510.11

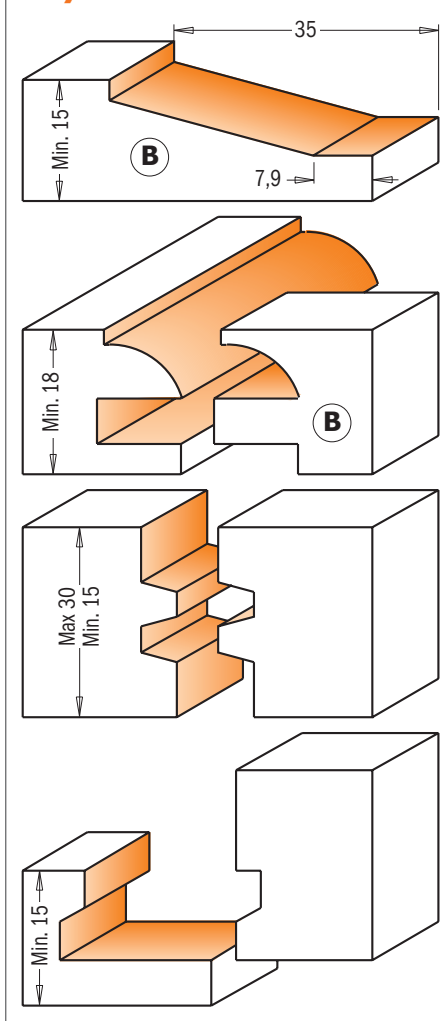

8/900.511.11

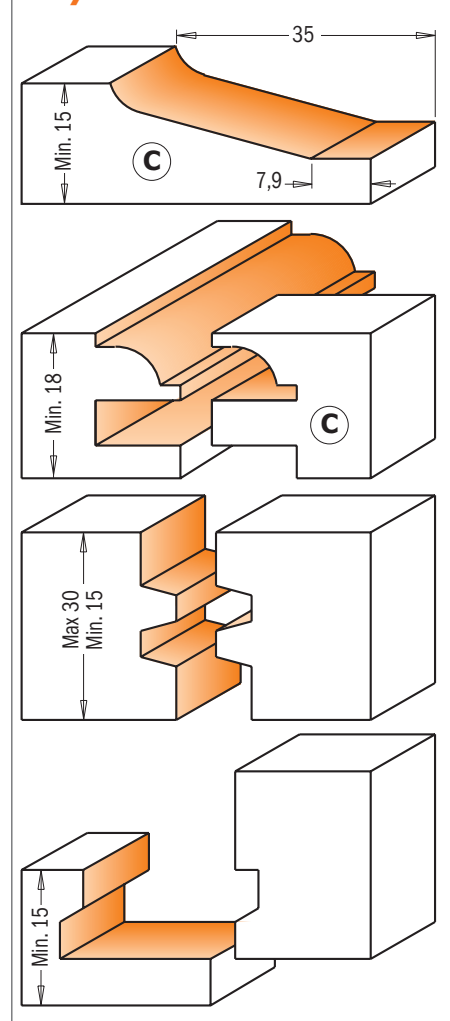

Drawing is 1:1 scale

Panelign Strips

Beautiful panel doors can be ruined by a poorly-aligned panel. Next time, slip panelign strips into the rails to keep panels perfectly centred while allowing for expansion. Unlike carpet foam, which eventually loses elasticity and ceases to work, the rubber in panelign strips is specially designed to spring back indefinitely. The rectangular shape makes the strips easy to handle. Typical doors require 4 to 8 strips each.

DESCRIPTION	DIMENSION mm	QTY.	1	ORDER NO.
Panelign Strips	27x7x7mm	200	1	PNL-001

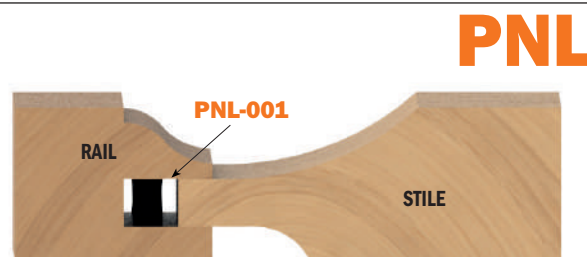

Adjustable Shaker Router Bit Sets



8/900.624

These new bit sets are excellent for producing adjustable tongue and groove joints with a bevel, in order to eliminate panel rattle that may occur with the production of standard cabinets. Cut precise grooves into your plywood veneered panels and make perfect rattle-free fits. To be used on table-mounted routers. Avoid using these bits in hand-held power tools.

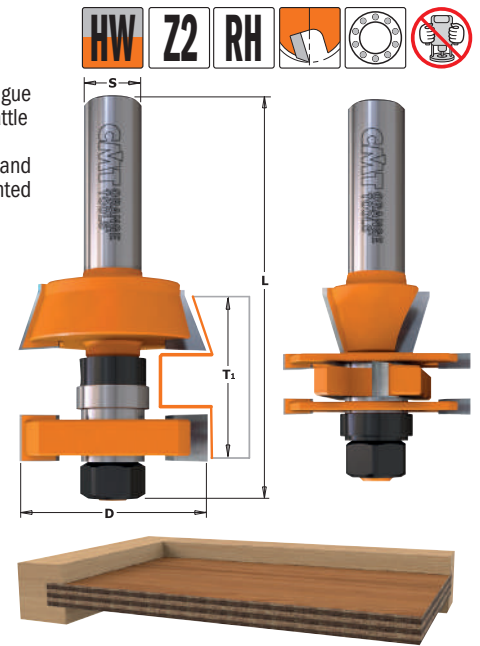
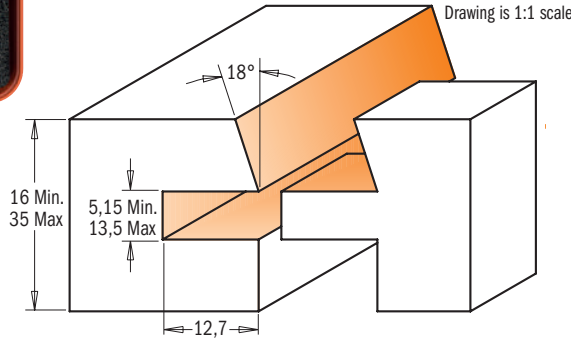

D mm	T1 mm	A	L mm	Box	ORDER NO. S=Ø12mm	ORDER NO. S=Ø12,7mm
41,2	16-35	18°	87	5	900.624.11	800.624.11

Spare parts

791.025.00	3,7mm 822.025.11	7,14mm 822.026.11	3,7mm 822.027.11	10,4mm 822.028.11	990.020.00
------------	------------------	-------------------	------------------	-------------------	------------

Spare parts: 541.515.00 0,1mm spacer
541.516.00 0,3mm spacer
541.517.00 0,5mm spacer

541.518.00 1mm spacer
541.500.00 3mm spacer
541.519.00 5,8mm spacer

Adjustable Tongue & Groove Bit Set for Mission Style Cabinet Doors



8/900.625

Exclusive CMT design which allows the perfect fit for undersized plywood panel. The tongue cutter features opposing shear angles to obtain flawless finishing on a large variety of materials such as plywood, softwood and hardwood.

For use on a table-mounted router. Not for handheld routers.

- Adjustable in 0.050mm (0.002") increments;
- For groove width from 5mm to 13,5mm;
- Cut stock thickness of 12,7mm to 31,7mm;
- Features micrograin carbide for longer life.
- Features micrograin carbide for longer life.

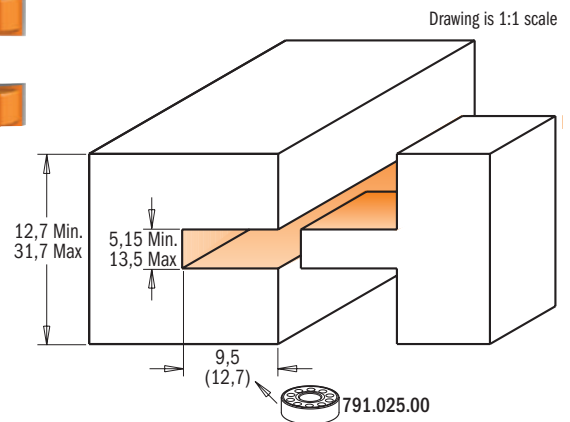
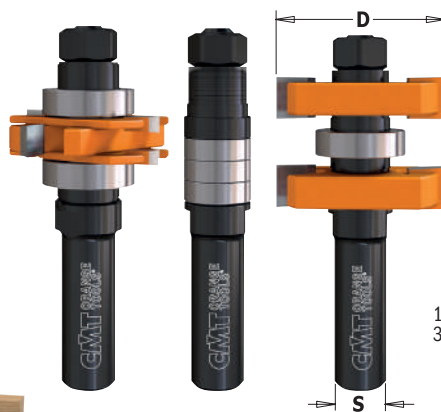

D mm	T1 mm	Box	ORDER NO. S=Ø12mm	ORDER NO. S=Ø12,7mm
41,2	5,15-13,5	5	900.625.11	800.625.11
41,2	12,7-31,7	5		800.625.11

Spare parts

924.136.00	8-22mm 791.012.00	3,7mm 822.025.11	7,14mm 822.026.11	3,7mm 822.027.11	10,4mm 822.028.11	990.020.00
824.136.00	791.012.00	822.025.11	822.026.11	822.027.11	822.028.11	990.020.00

Spare parts: 541.515.00 0,1mm spacer
541.516.00 0,3mm spacer
541.517.00 0,5mm spacer

541.518.00 1mm spacer
541.500.00 3mm spacer
541.519.00 5,8mm spacer

Slot Cutter Sets



8/923.001

Create slots, grooves and rabbets on all materials using these slot cutter sets. Ideal for biscuit and tongue and groove joints. These sets include 4 different bearings to allow a cutting depth of 8mm, 9,5mm, 12,8mm and 14,3mm. Please refer to the chart below for applications and the correct cutter combinations.

SAFETY TIPS: never use the slot cutter sets without shims between cutters, whose distance can vary from 1mm to 1,7mm. Shims can also be positioned between the ball bearings and the cutters.



ASSEMBLY ILLUSTRATION

924.081.10 S=8mm
824.121.10 S=12,7mm
924.082.10 S=8mm
824.122.10 S=12,7mm
924.080.10 S=8mm
824.127.10 S=12,7mm
924.083.10 S=8mm
824.128.10 S=12,7mm

47,6

H

Spare parts		
H mm	Order No.	Order No.
14,3	8-19	791.034.00
12,7	8-22	791.005.00
9,5	8-28,5	791.030.00
8	8-31,5	791.033.00

DESCRIPTION	Box	ORDER NO. S=Ø8mm	Spare parts								
			2mm	3mm	4mm	5mm	6mm	924.081.10	924.082.10	924.080.10	924.083.10
Slot cutter set	1	923.001.11	822.320.11	823.330.11	823.340.11	823.350.11	822.360.11	924.081.10	924.082.10	924.080.10	924.083.10

DESCRIPTION	Box	ORDER NO. S=Ø12,7mm	Spare parts								
			1,6mm	3,2mm	4mm	4,8mm	6,4mm	824.121.10	824.122.10	824.127.10	824.128.10
Slot cutter set	1	823.001.11	822.316.11	823.332.11	823.340.11	822.348.11	822.364.11	824.121.10	824.122.10	824.127.10	824.128.10

5-Piece Straight Bit Set & Profile Bit Set

A three 5-piece set with a selection of straight bits and the most popular profile router bits. Sold in a robust protective carry case.



900.005.01

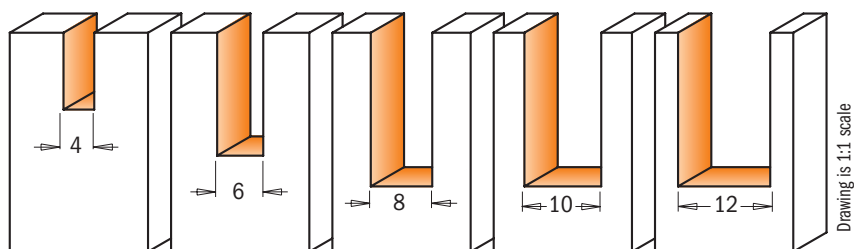

DESCRIPTION	Box	ORDER NO. S=Ø8mm
5-Piece Straight Bit Set	5	900.005.01

7/900.005.03

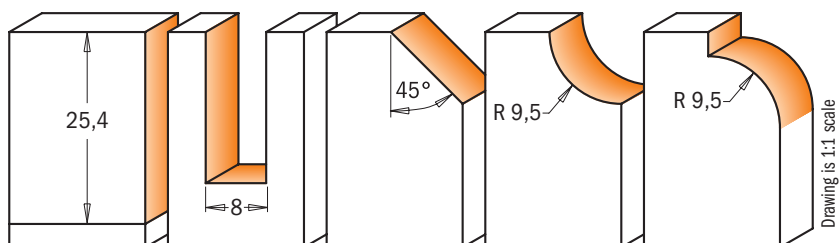

DESCRIPTION	Box	ORDER NO. S=Ø6mm	ORDER NO. S=Ø8mm
5-Piece Profile Bit Set	5	700.005.03	900.005.03

Router Bit Set with Insert Knives



600.005.01

This set is the perfect companion for the professional craftsman. We offer the 5 most popular bits with reversible knives complete with 10 spare knives and 2 TORX® keys. They are perfect for working on all materials such as solid wood, wood derivatives, laminates, MDF, and plastic materials. For use with a hand held, point-to-point machine or CNC router.



SAFETY TIPS:



The **TW-006** Torque Screwdriver is recommended for the proper fastening of screws (see page 406).

DESCRIPTION		ORDER NO. S=Ø8mm
Router Bit Set with Insert Knives	1	600.005.01

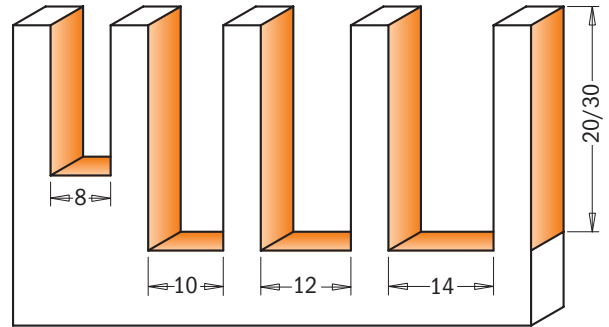

Drawing is 1:1 scale

10 spare knives and 2 TORX® keys included

SET CONTAINS	D mm	I mm	KNIVES		ORDER NO. S=Ø8mm
Straight Router Bit with Knife	8	20	790.200.01 - 20 x 4,1 x 1,1mm		651.080.11
Straight Router Bit with Knife	10	30	790.300.01 - 30 x 5,5 x 1,1mm		651.100.11
Straight Router Bit with Knife	12	30	790.300.01 - 30 x 5,5 x 1,1mm		651.120.11
Straight Router Bit with Knife	14	30	790.300.01 - 30 x 5,5 x 1,1mm		651.140.11
Flush Trim Bit with Knife	19	30	790.300.00 - 30 x 12 x 1,5mm	791.007.00	657.191.11

5-Piece Spiral Bit Sets



191.0/192.0



This new set of high quality solid tungsten carbide upcut and downcut spiral bits come in the most popular diameters: 4-8-10-12mm. These bits featuring sharp long-lasting cutting edges guarantee perfect high quality cuts, and the spiral layout allows for a more efficient chip ejection. Recommended for use on hardwood, wood derivatives, laminates and plastic materials.

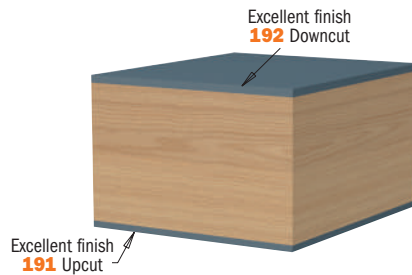

DESCRIPTION		ORDER NO. S=Ø8mm	ORDER NO. S=Ø6,35-12,7mm
5-Piece Upcut Spiral Bit Sets (Ø4 - 6 - 8 - 10 - 12mm)	5	191.000.01	
5-Piece Downcut Spiral Bit Sets (Ø4 - 6 - 8 - 10 - 12mm)	5	192.000.01	
5-Piece Upcut Spiral Bit Sets (Ø4,76 - 6,35 - 8 - 9,5 - 12,7mm)	5		191.000.02
5-Piece Downcut Spiral Bit Sets (Ø4,76 - 6,35 - 8 - 9,5 - 12,7mm)	5		192.000.02

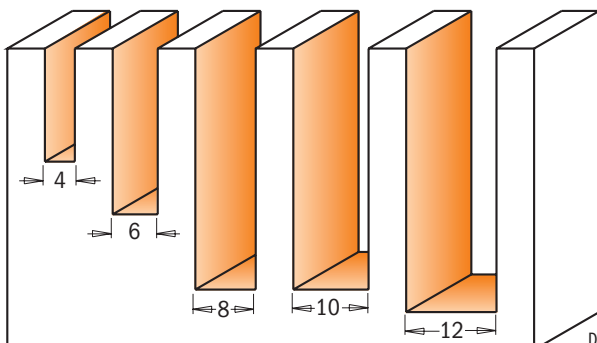

Drawing is 1:1 scale

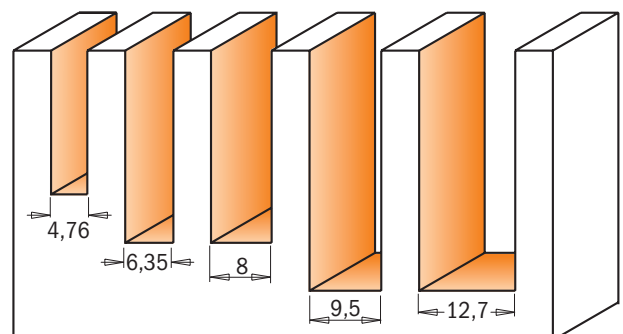

CONTRACTOR ROUTER BIT FROM CMT



Deluxe packaging



For value-driven contractors, remodelers and DIYers. Great quality/price ratio and long-lasting performance.



HEAT-TREATED SHANK & BODY FOR GREATER DURABILITY

The bits are made from the finest steel hardened to reach 58 Rockwell which ensures durability and good cutting performance.



ANTI-KICKBACK DESIGN

Controls depth of cut and minimizes kickback reducing your risk of injury.



SINTERHIP HI-DENSITY CARBIDE

New process called SinterHIP (Hot Isostatic Pressing), helps prevent material failure and increases cutting life.



CORROSION-FREE BLACK COATING

Protects against corrosion and provides a longer bit life.

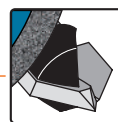

PRECISION GROUND CUTTING EDGES

Each cutting edge is precisely sharpened to obtain a sharp and durable cutting angle.

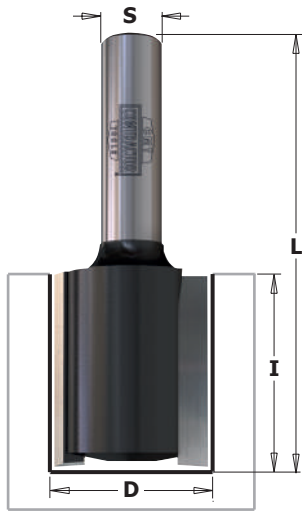

K911-K912

Designed for making slots and routing channels in wood and wood composites. Hi-Density carbide-tipped cutting edges provide smooth performance and a precise cut. Engineered for efficient chip clearance.



D mm	I mm	L mm	Z		ORDER NO. S=Ø8mm
3	8	51	1	10	K911-030
4	11	51	1	10	K911-040
5	12,7	51	1	10	K911-050
6	16	51	1	10	K911-060
6	25,4	57	2	10	K912-060
8	20	51	2	10	K911-080
8	32	62	2	10	K912-080
10	20	51	2	10	K911-100
10	32	62	2	10	K912-100
12	20	51	2	10	K911-120
12	32	62	2	10	K912-120
14	25,4	56	2	10	K911-140
15	25,4	56	2	10	K911-150
16	25,4	56	2	10	K911-160
18	25	56	2	10	K911-180
20	25	56	2	10	K911-200
22	25,4	56	2	10	K911-220
24	25,4	56	2	10	K911-240
25	25,4	57	2	10	K911-250

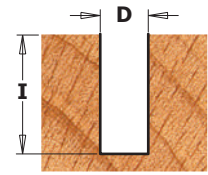

Drawing is 1:1 scale

Straight Bits with Centre Tip

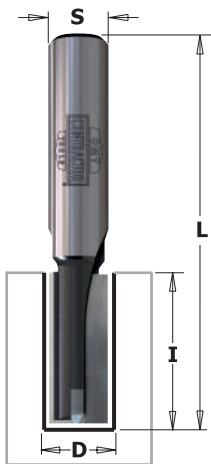

K174

Thanks to the center tip the cutting edge allows you to execute any kind of plunge drilling and trimming jobs on soft or hardwood, wood composites and plastic or laminated materials.



D mm	I mm	L mm	Z		ORDER NO. S=Ø8mm
8	20	51	2+1	10	K174-080
8	40	90	2+1	10	K174-082
10	20	51	2+1	10	K174-100
10	40	90	2+1	10	K174-101
12	20	51	2+1	10	K174-120
12	40	90	2+1	10	K174-121
16	20	51	2+1	10	K174-160
16	40	90	2+1	10	K174-161
18	20	51	2+1	10	K174-180
20	20	51	2+1	10	K174-200
22	20	70	2+1	10	K174-220

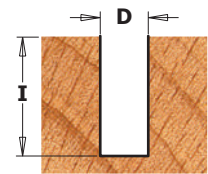

Drawing is 1:1 scale

PLUNGE CENTRE TIP

This particular kind of cutting edge guarantees long-lasting performance during plunging operations.

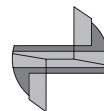

Pattern Bits

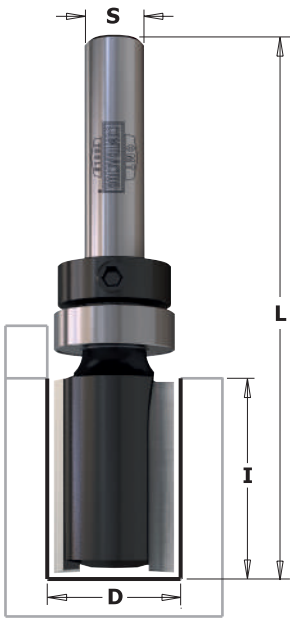

K911B

Our pattern bit makes template routing easy and accurate. Create cabinets, furniture, signs, toys or just about any other project you can imagine. Our smooth-running top bearing will glide along your template creating a perfect copy in the wood piece below.



D mm	I mm	L mm	Z		ORDER NO. S=Ø8mm
16	25,4	70	2	10	K911-160B
22	25,4	70	2	10	K911-220B

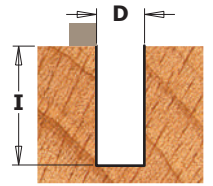

Drawing is 1:1 scale

Flush Trim Bits



K906

Precise flush trimming of wood or laminate material. Bottom bearing runs effortlessly against finished work piece delivering a smooth to the touch flush trim cut. Two carbide-tipped cutting edge design optimizes performance.



I mm	D mm	L mm	Z		ORDER NO. S=Ø8mm
14	9,5	56	2	10	K906-096
25,4	12,7	67	2	10	K906-127
25,4	19	67	2	10	K906-191

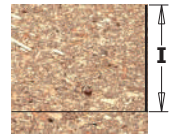

Drawing is 1:1 scale

Round Nose Bits

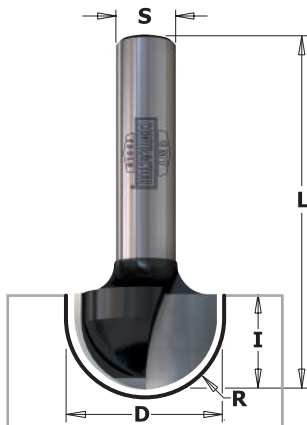

K914

Designed for sign and cabinet makers. Use the round nose to make decorative doors, drawer fronts, signs or add a design to any other creative project. Features two carbide-tipped cutting edges that provide a smooth cut in wood and wood derivatives.



R mm	D mm	I mm	L mm		ORDER NO. S=Ø8mm
3	6	9,5	40	10	K914-060
4,75	9,5	9,5	40	10	K914-095
6,35	12,7	12,7	40	10	K914-127
8	16	12,7	45	10	K914-160
9,5	19	12,7	46	10	K914-190

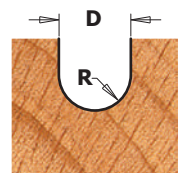

Drawing is 1:1 scale

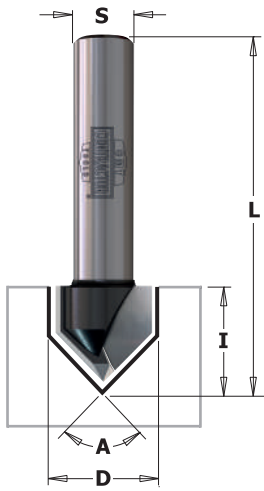

K915-K958



Make a clean sharp v-groove in panel and drawer fronts for decorative projects. Good for engraving letters for signs, they feature two sharp carbide-tipped cutting edges for smooth fast cutting. Choose from our 60° or 90° V-groove angle.

D mm	I mm	A	L mm	Z		ORDER NO. S=Ø8mm
12,7	12,7	90°	45	2	10	K915-127
16	16	90°	45	2	10	K915-160
31,8	20	90°	60	2	10	K915-317
11	14	60°	45	2	10	K958-110

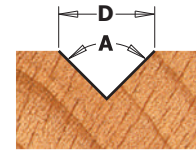

Drawing is 1:1 scale

Decorative Ogee Bit



K965



This new CMT bit produces a classic single or double-edged bead. Ideal for creating a marked decorative effect on panel, door and drawer work.

D mm	d mm	I mm	R mm	L mm		ORDER NO. S=Ø8mm
10	1,3	10	5	50,8	10	K965-100

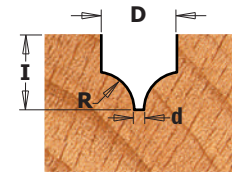

Drawing is 1:1 scale

Keyhole Bit



K950



Easily create a hardware-free way to hang pictures and plaques on a wall. Cuts a key-holed groove or slot in a variety of materials such as wood, plywood and laminates.

D mm	d mm	I mm	L mm		ORDER NO. S=Ø8mm
9,5	4,76	11,1	48	10	K950-095

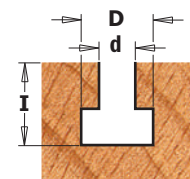

Drawing is 1:1 scale

Dovetail Bit

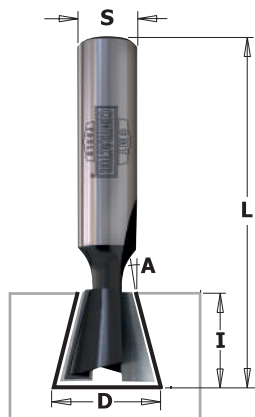

K918

Use our bits with some of the most popular dovetail jigs on the market to create clean dovetail joints in wood and wood composite material. Balanced for good performance.



D mm	I mm	L mm	A		ORDER NO. S=Ø8mm
12,7	12	45	14°	10	K918-127

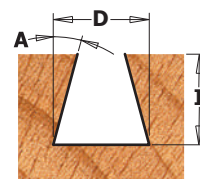

Drawing is 1:1 scale

Slot Cutters

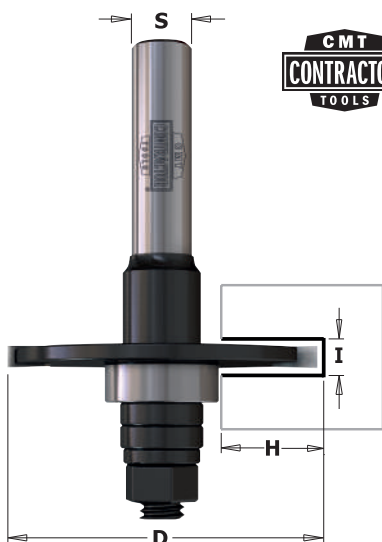

K922

Uses for these 2 wing slot cutter are almost infinite. Cut slots and grooves for splines, biscuits, T-molding or tongue and groove joints.



NOTE: For biscuit joints, use I=4mm slot cutter.

I mm	D mm	H mm	Z		ORDER NO. S=Ø8mm
3	40	12,5	2	10	K922-330A
4	40	12,5	2	10	K922-340A
5	40	12,5	2	10	K922-350A
6	40	12,5	2	10	K922-360A

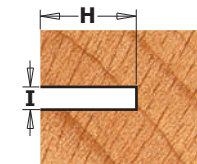

Drawing is 1:1 scale

Chamfer Bit

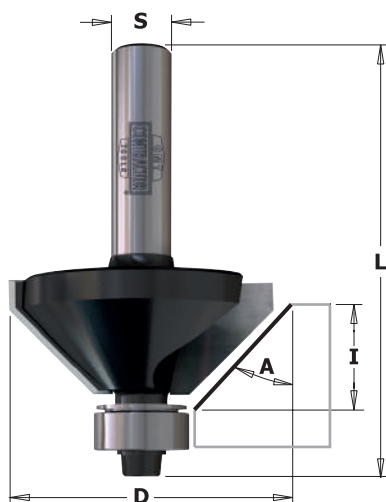

K936

Produce clean, accurate bevel or chamfer edges for edge jointing, decorative edges or perfectly aligned boxes. Features two carbide-tipped cutting edges, anti-kickback design with heat treated shank and body for durability. Bottom bearing included.



D mm	I mm	A	L mm		ORDER NO. S=Ø8mm
35	15	45°	56	10	K936-350

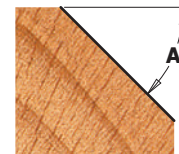

Drawing is 1:1 scale

Rabbeting Bit

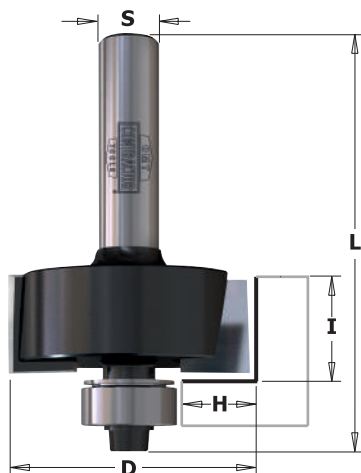

K935



Ideal for creating inset doors and drawer fronts or to re-groove old window frames to accept a panel of glass. Features two carbide-tipped cutting edges, anti-kickback design with heat treated shank and body for durability. Bottom bearing included.

D mm	I mm	H mm	L mm		ORDER NO. S=Ø8mm
31,8	12,7	9,5	54	10	K935-317

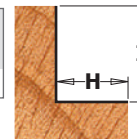

Drawing is 1:1 scale

Cove Bits

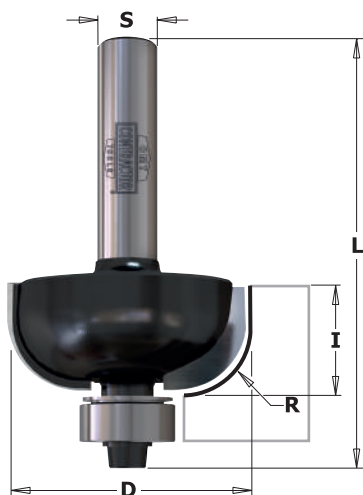

K937



Give your doors and drawer fronts an elegant touch. Pair a cove bit with a roundover bit to create decorative elements on your furniture projects. Features two carbide-tipped cutting edges, anti-kickback design, heat treated shank and body for durability. Bottom bearing included.

D mm	I mm	R mm	L mm		ORDER NO. S=Ø8mm
31,8	14	9,5	56	10	K937-317
38,1	16	12,7	62	10	K937-380

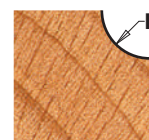

Drawing is 1:1 scale

Ovolo Bit



K927



Ideal for furniture makers, you get a roundover with top and bottom bead all in one. Bit equipped with two carbide-tipped cutting edges, features anti-kickback design and heat treated shank and body for increased durability.

D mm	I mm	R mm	L mm		ORDER NO. S=Ø8mm
25,4	14,3	6,3	46	10	K927-064

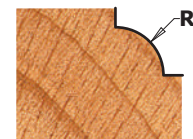

Drawing is 1:1 scale



K938

A popular profile for taking the edge off a sharp corners. When partnered with a cove bit, you can create a drop-leaf table or other intricate projects. Bits equipped with two carbide-tipped cutting edges, anti-kickback design, and heat treated shank/body for increased durability. Bottom bearing included.



D mm	I mm	R mm	L mm		ORDER NO. S=Ø8mm
16,7	7,9	2	51	10	K938-167
18,7	10,5	3	53	10	K938-187
22,2	12,7	4,8	54	10	K938-222
25,4	13,5	6,3	55	10	K938-254
28,7	15,5	8	53	10	K938-287
31,8	16,5	9,5	58	10	K938-317
38,1	19	12,7	61	10	K938-380
44,7	22,2	16	67	10	K938-445

Roundover

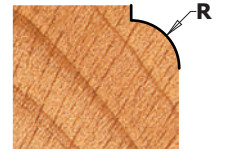

Beading

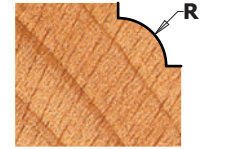

Drawing is 1:1 scale



EACH BIT INCLUDES A 9mm (3/8") BEARING FOR BEADING PROFILES

Roman Ogee Bit

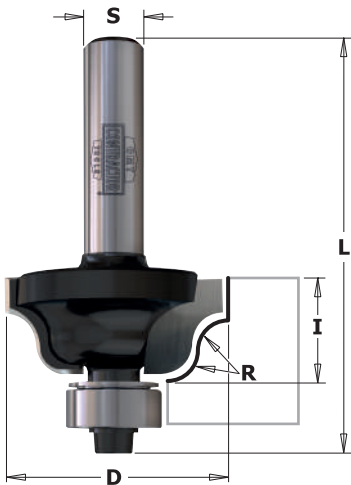

K940

A very popular bit for making a wavy profile which, gives a touch of class to your furniture. These bits feature an anti-kickback design, rust-resistant black coating and include a smooth running bearing for template work.



D mm	I mm	R mm	L mm		ORDER NO. S=Ø8mm
28,6	12,7	4	54	10	K940-286



Drawing is 1:1 scale

Classical Ogee Bits

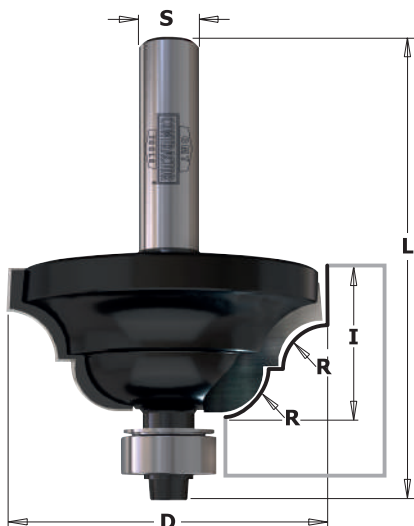

K941

This bit produces both a concave and a convex profile on your work piece for smooth eye-catching detail! They feature 2 sharp cutting edges, rust-resistant black coating and are equipped with a bottom bearing for easy template work on both natural wood and wood-based materials.



D mm	I mm	R mm	L mm		ORDER NO. S=Ø8mm
42,9	18	6,3	60	10	K941-430

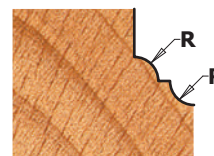

Drawing is 1:1 scale

Finger Pull Bit

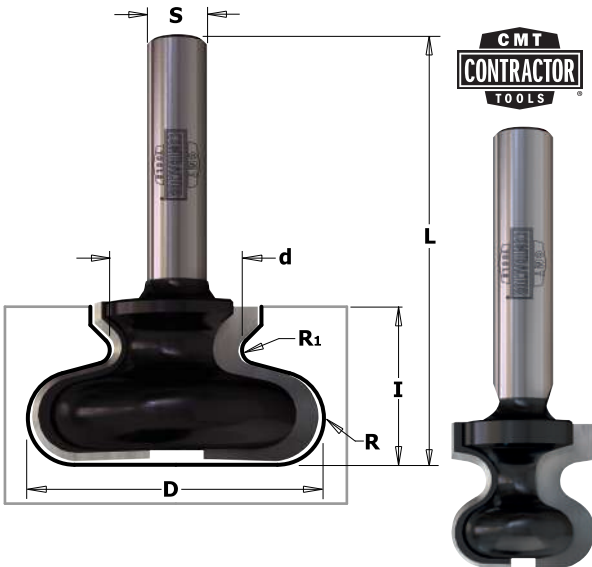

K955



Why interrupt the subtle linearity of an all-wood drawer front or cabinet door with a metal knob or handle? Use these finger pull bits and make a harmonious wooden handle. Two options are available: a template profile made directly in the wood or a European-style hardwood pull as illustrated below.

D mm	d mm	I mm	R mm	R ₁ mm	L mm		ORDER NO. S=Ø8mm
19,05	9,5	19,05	4,8	2,4	57,2	10	K955-190
38,1	17	20,7	6	1,8	55,4	10	K955-380

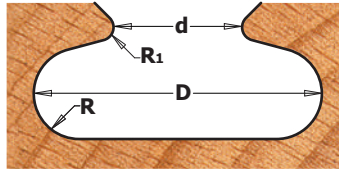

Drawing is 1:1 scale

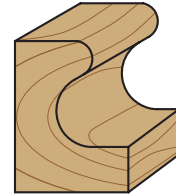

5-Piece Straight Router Bit Set

new



K900-005-01



D mm	I mm	L mm	Z	ORDER NO. S=Ø8mm
4	11	51	1	K911-040
6	16	51	1	K911-060
8	20	51	2	K911-080
10	20	51	2	K911-100
20	25	56	2	K911-200

5-Piece Basic Router Bit Set

new



K900-005-02



D mm	I mm	R mm	L mm	A	ORDER NO. S=Ø8mm
12	20		51		K911-120
16	25,4		70		K911-160B
12,7	25,4		67		K906-127
25,4	13,5	6,3	55		K938-254
35	15		56	45°	K936-350

Replacement Bearing Set

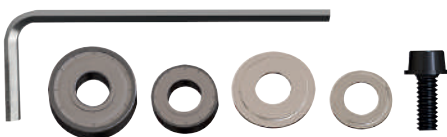

79101

PACK QTY. 10

SET INCLUDES	PIECES
3/8" Bearing	1
1/2" Bearing	1
3/8" Dust Shields	1
1/2" Dust Shields	1
Screw	1
Hex Key	1

What work parameters are best when routing?

Answering the following questions will provide you with the answer!

- **What equipment are you using?** Using brand new equipment of high quality is not the same as using outdated machinery! It is important to understand that vibration is the direct result of wear and tear, which can lead to a poor quality finish. Feed rate should be chosen in order to dampen vibration, and quite often, higher feed rates are associated with better finishing results.
- **What factors influence the performance of the bit I am using?** Many factors affect performance and the ultimate finish of the workpiece: the power of the collet chuck, the rigidity and eccentricity of the couplings, conditions and quality of the collets, reverse locking system, sharpened tool edge, the dust-collection system in use and even the relative humidity of the workplace environment.
- **What bit should I use?** The number of cutting edges as well as the cutting diameter significantly affect work parameters. In general, the more cutting edges and the wider the blade diameter, the higher the feed rate.
- **What is the cutting depth I hope to carry out?** In order to increase cutting depth, it is necessary to reduce the feed rate and vice versa for shallower cuts.
- **At what speed does my machine run?** By increasing the spindle speed (rpm), the quality of the finished edge improves. However, at the same time friction also increases between the tool and the workpiece. As a result, tool longevity is compromised. Ideally, the objective is to select the slowest rotation speed possible compatible with the quality of finishing you hope to achieve.
- **What edge finish am I looking to achieve?** Coarse routing and fine routing are definitely not the same thing! You need to figure out what is more important: quality or quantity. In order to prolong the life of your cutting tool, its best to choose the highest feed rate possible best suited to achieve the finish you want.
- **Above all...what materials am I working with?** Wood is a good example of natural fiber composite. It is made up of a natural fibrous material, both elastic and flexible (cellulose: long molecular polymer chains), bound together by a very rigid substance (lignin: cross-linked polymer) as well as a compatibilizer (hemicellulose: a polysaccharide). It is an anisotropic material, that is, directionally dependent, changing with direction along the object. How many types of wood and wood derivatives are you familiar with? Remember, no two pieces of wood are the same! In fact, the same work parameters carried out on two different pieces of wood will provide two very different results.

Feed rate is dependent of several factors, like the ones mentioned above - and these are just a few examples. It is important to weigh all factors in order to select an optimum feed rate suitable for the tools and work objectives involved. CMT is synonymous with quality and to produce high quality cuts you just can't randomly shoot off a bunch of numbers. Be wary of those who provide you with random numbers.

I get it....but where do I start? *The best way to go forward is step-by-step using reliable test data.* To quickly achieve the results best suited for your specific work expectations, you can always turn to theory!

One rule of thumb, which may prove advantageous, is to use a simple gauge to measure chipload wherever possible. On the one hand, it should be noted that when chips are too thick, breakage will occur, resulting in a poor, rough finish. On the other hand, when chips are too thin, it will negatively affect tool longevity and cause rapid wear and tear of the cutting edge because the teeth of the tool are rubbing more than removing material.

The next time you experiment, you need to properly assess the specific demands of the work involved, assess chipload measurements and try to orient yourself towards a different thickness by taking into account the aforementioned factors. Then, with the aid of the formulas listed below, proceed to establish the appropriate feed rate for your next test. This will help you to achieve better results faster and you will have the essential information you will need for the next work project.

PARAMETERS:

V = Feed rate (m/min)

Z = Cutting edges

C = Chipload (mm)

FORMULAS:

V = (RPM x Z x C)/1000

RPM = V x 1000 / (Z x C)

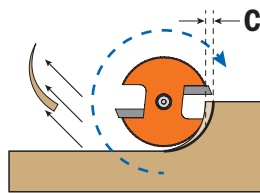

EXAMPLE:

with caliper take measurement of a good result chipload (C=0,2mm).

Z=2

RPM=18000

V = (RPM x Z x C)/1000 = (18000x2x0,2)/1000 = 7,2m/min

PROBLEM SOLVING

PROBLEM

Bad finishing
Cutting edge wear
Cutting edge burns
Cutting edge debris
Vibrations
Cutter breakage

SOLUTIONS

• Cutting depth • Vibrations
• Rotation speed • Vibrations
• Rotation speed • Number of cutting-edges
• Cutting depth
• Rotation speed • Cutting depth
• Feed speed • Cutting depth • Vibrations

INCREASE

• Rotation speed • Dust extraction • Number of cutting edges • Clamping cutter/chuck
• Feed speed
• Feed speed
• Rotation speed • Feed speed • Dust extraction
• Machine firmness • Workpiece firmness
• Shank diameter • Collet clamping • Change tool material (solid carbide or DENSIMET®)

DECREASE

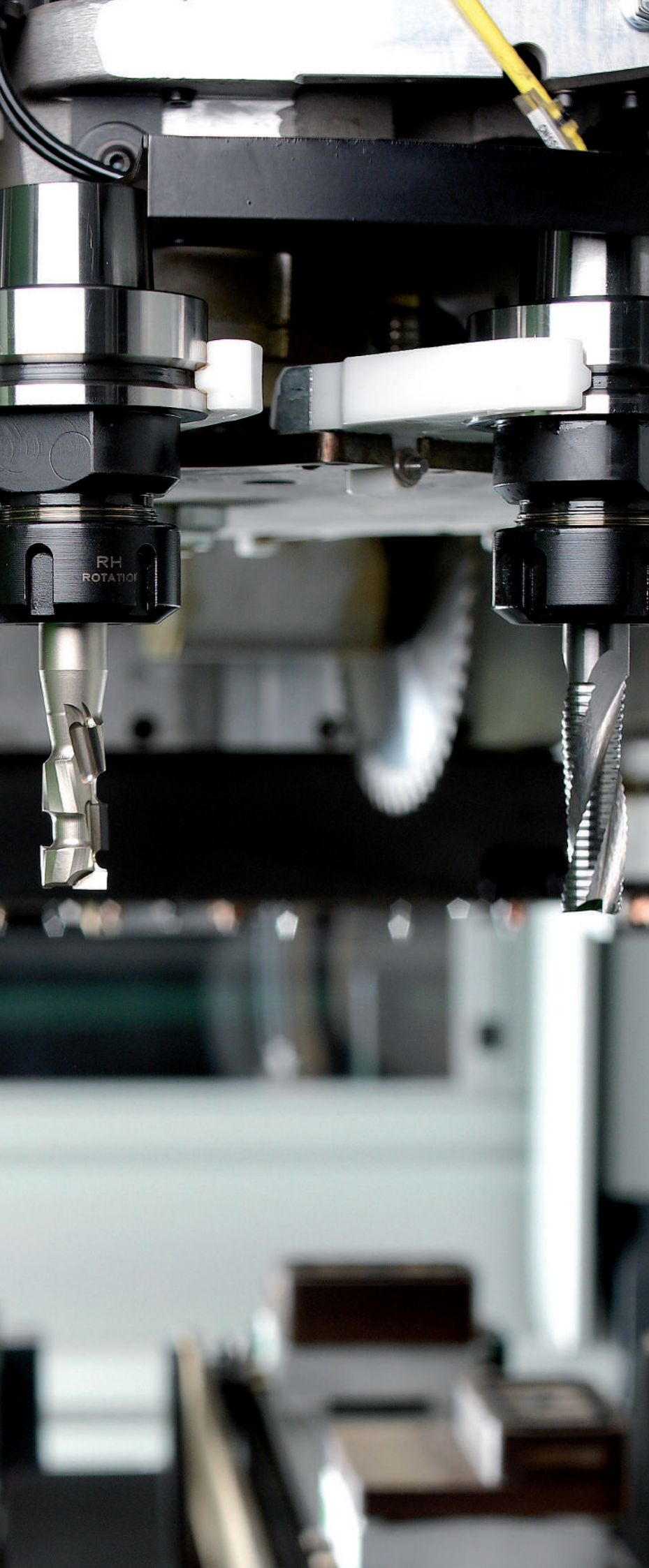

CNC ROUTER CUTTERS & CHUCKS

PRODUCTS	PAGE
Kinetic Dust Extractor	272
CNC Chucks	273~275
Precision Collets	276-277
Clamping Nuts	277
C-Spanner & Retaining Studs	278
HSK Chucks for Grooving Blade	278-279
Cutter Arbor	280
Universal Assembly Supports for Chucks	280
DLCS Coating Solid Carbide Spiral Bits	281-282, 285, 289
Solid Carbide Spiral Bits	282~290, 292
Spiral Bits for Locksets	291
HSS Upcut Spiral Bits	291
Solid Surface and Fiberglass Bits	293
CNC DP Straight Cutters	294~298
CNC Straight Carbide Cutters	298~301
CNC Cutters with Insert Knives	302~309
Slot & Mortise Bits	310~316



Kinetic Dust Extractor



992 Removes MDF & Chipboard dust from the workpiece

DESCRIPTION	D mm		ORDER NO.
Kinetic Dust Extractor for chucks with ER20	80	1	992.081.ER20
Kinetic Dust Extractor for chucks with ER25	80	1	992.081.ER25
Kinetic Dust Extractor for chucks with DIN6388/EOC25 collets	100	1	992.101.EOC25
Kinetic Dust Extractor for chucks with ER32 collets	100	1	992.101.ER32
Kinetic Dust Extractor for chucks with ER40 collets	100	1	992.101.ER40

Spare parts: **991.285.00** C-Spanner 80-90mm (ER20/ER25)
991.284.00 C-Spanner 95-100mm (EOC25/ER32/ER40)



EASY TO USE!

Installation and removal just like a clamping nut

- Better health & safety on the worksite
- Better air quality on the worksite
- Improves tool performance & cut quality
- Longer tool life & reduced labor costs
- Recommended for Nesting and routing operations
- No wasted time throughout operation
- Replaces the standard clamping nut
- Suitable for any collet chucks with standard router bits
- Available for ER32 - ER40 - EOC25 (DIN6388) collets
- Tough ceramic coating offers anti-corrosion, anti-friction and anti-static protection.
- Tool body in light alloy
- Lightweight and quiet
- Performs even at low RPM: from 6,000 up to 20,000 rpm
- Materials: chipboard, coated chipboard, MDF, CORIAN®, plasterboard, OSB, HPL.

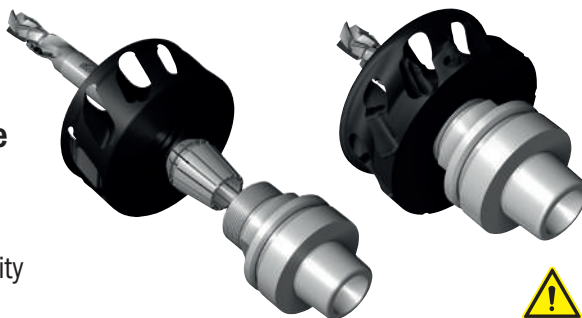

SAFETY TIPS:

The **TW-200** Torque Wrench is recommended for the proper fastening of clamping nuts (see page 406)

Always use vacuum system.

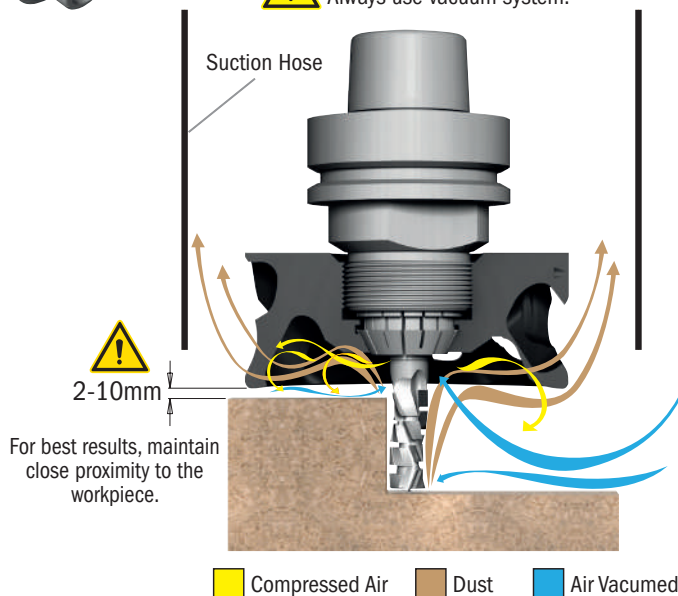

Download Instruction



Watch the video on
YouTube

Working **WITHOUT** Kinetic Dust Extractor



Working **WITH** Kinetic Dust Extractor



HSK-63F Chuck for "ER32" Precision Collets

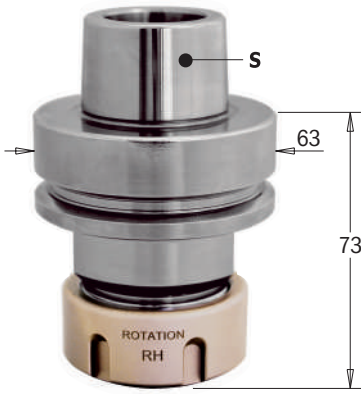

183.300 XTREME



S	TO BE USED WITH COLLET	ORANGE CHROME	NOTE	BOX	ORDER NO. Right-hand rotation	ORDER NO. Left-hand rotation
HSK-63F	ER32	✓	Clamping nut without bearing	1	183.300.01	183.300.02
HSK-63F	ER32	✓	Clamping nut with bearing	1	183.300.11*	
HSK-63F	ER32		Clamping nut without bearing	1	183.300.91	
HSK-63F	ER32		Clamping nut with bearing	1	183.300.93*	

Optional: 990.118.00 M6x10mm screw

* Suitable for right-hand and left-hand rotation.

For HOMAG®, EIMA®, IMA® FROM 9/94, WEEKE®, BIESSE®, SCM®, MORBIDELLI® and MASTERWOOD® machines.



Non-Stick Orange Chrome® SHIELD COATING

- prevents overheating
- protects against corrosion and rust
- reduces resin build-up
- longer life and greater tool performance

SAFETY TIPS:



The **TW-200** Torque Wrench is recommended for the proper fastening of clamping nuts (see page 406)

HSK-63F Chucks for "ER40" Precision Collets

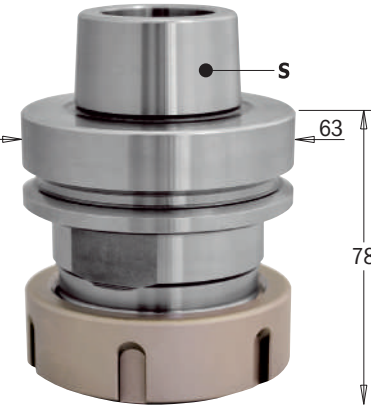

183.310 XTREME



S	TO BE USED WITH COLLET	ORANGE CHROME	NOTE	BOX	ORDER NO. Right-hand rotation	ORDER NO. Left-hand rotation
HSK-63F	ER40	✓	Clamping nut without bearing	1	183.310.01	183.310.02
HSK-63F	ER40	✓	Clamping nut with bearing	1	183.310.11*	
HSK-63F	ER40		Clamping nut without bearing	1	183.310.91	
HSK-63F	ER40		Clamping nut with bearing	1	183.310.93*	

Optional: 990.117.00 M6x6mm screw

* Suitable for right-hand and left-hand rotation.

For HOMAG®, EIMA®, IMA® FROM 9/94, WEEKE®, BIESSE®, SCM®, MORBIDELLI® and MASTERWOOD® machines.



Non-Stick Orange Chrome® SHIELD COATING

- prevents overheating
- protects against corrosion and rust
- reduces resin build-up
- longer life and greater tool performance

SAFETY TIPS:



The **TW-200** Torque Wrench is recommended for the proper fastening of clamping nuts (see page 406)

HSK-63F Chucks for "EOC25" Precision Collet "DIN6388"

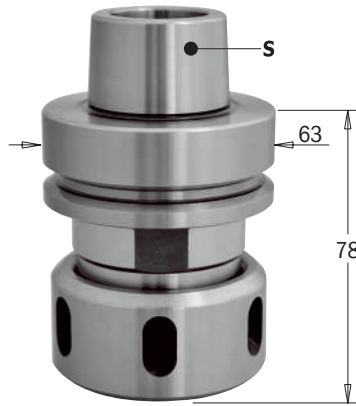

183.320



S	TO BE USED WITH COLLET	NOTE	BOX	ORDER NO. Right-hand rotation	ORDER NO. Left-hand rotation
HSK-63F	EOC25	Clamping nut with bearing	1	183.320.01*	
HSK-63F	EOC25	Clamping nut without bearing	1	183.320.03	

Spare parts: 992.283.01 Clamping nut without bearing
992.283.11 Clamping nut with bearing

* Suitable for left-hand rotation too.

For HOMAG®, EIMA®, IMA® FROM 9/94, WEEKE®, BIESSE®, SCM®, MORBIDELLI® and MASTERWOOD® machines.



Non-Stick Orange Chrome® SHIELD COATING

- prevents overheating
- protects against corrosion and rust
- reduces resin build-up
- longer life and greater tool performance

SAFETY TIPS:



The **TW-200** Torque Wrench is recommended for the proper fastening of clamping nuts (see page 406)

HSK-63F Chucks for Shrink Fit Holders

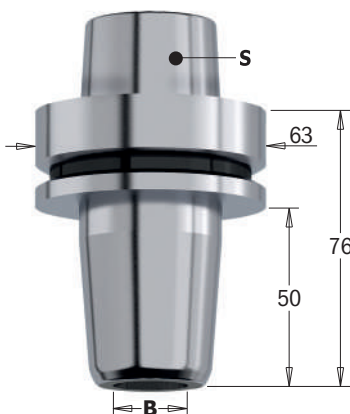

183.075



S	B mm	BOX	ORDER NO.
HSK-63F	12	1	183.075.12
HSK-63F	16	1	183.075.16
HSK-63F	20	1	183.075.20
HSK-63F	25	1	183.075.25

SPECIAL STEEL UNI 1.2344

- prevents overheating
- protects against corrosion and rust
- longer life and greater tool performance

ISO30 Chucks for "ER32" Precision Collets

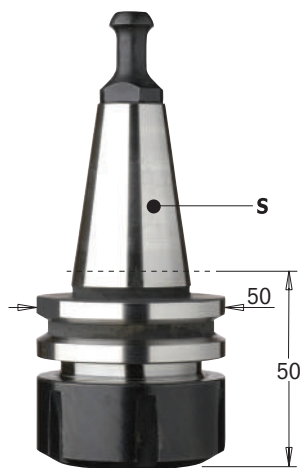

995.200

183.200

S	TO BE USED WITH COLLET	RETAINING STUD mm		ORDER NO. Right-hand rotation	ORDER NO. Left-hand rotation
ISO30	ER32	Ø12-8	 1	183.200.01	183.200.02

For BIESSE® machines.

RH LH



995.201

183.210

S	TO BE USED WITH COLLET	RETAINING STUD mm		ORDER NO. Right-hand rotation	ORDER NO. Left-hand rotation
ISO30	ER32	Ø13-9	 1	183.210.01	183.210.02

For BIESSE® machines with OMLAT® engine, NUOVA BULLERI BREVETTI®, BUSELLATO®, CMS® and IMA® machines.

RH LH



995.202

183.220

S	TO BE USED WITH COLLET	RETAINING STUD mm		ORDER NO. Right-hand rotation	ORDER NO. Left-hand rotation
ISO30	ER32	Ø12,8-9	 1	183.220.01	183.220.02

For ALBERTI® and MASTERWOOD® machines.

RH LH

SAFETY TIPS:



The **TW-200** Torque Wrench is recommended for the proper fastening of clamping nuts (see page 406)

ISO30 Chucks for "ER40" Precision Collets

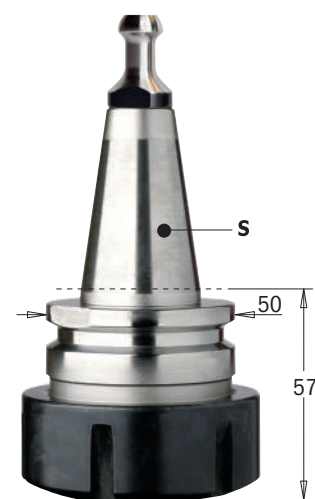

995.200

183.201

S	TO BE USED WITH COLLET	RETAINING STUD mm		ORDER NO. Right-hand rotation	
ISO30	ER40	Ø12-8	 1	183.201.01	

For BIESSE® machines.

RH



995.201

183.211

S	TO BE USED WITH COLLET	RETAINING STUD mm		ORDER NO. Right-hand rotation	
ISO30	ER40	Ø13-9	 1	183.211.01	

For BIESSE® machines with OMLAT® engine, NUOVA BULLERI BREVETTI®, BUSELLATO®, CMS® and IMA® machines.

RH



995.202

183.221

S	TO BE USED WITH COLLET	RETAINING STUD mm		ORDER NO. Right-hand rotation	
ISO30	ER40	Ø12,8-9	 1	183.221.01	

For ALBERTI® and MASTERWOOD® machines.

RH

SAFETY TIPS:



The **TW-200** Torque Wrench is recommended for the proper fastening of clamping nuts (see page 406)

ISO30 Chucks for "ER32" Precision Collets

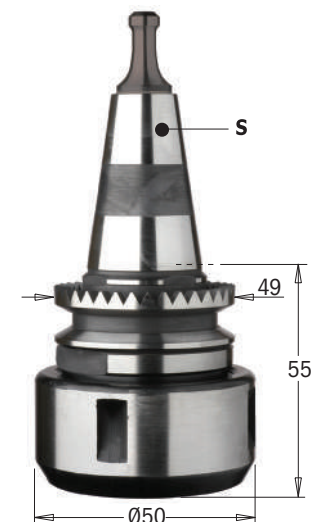

995.250

183.250

S	TO BE USED WITH COLLET	RETAINING STUD mm		ORDER NO. Right-hand rotation	ORDER NO. Left-hand rotation
ISO30	ER32	Ø8,5	 1	183.250.01	183.250.02

For MORBIDELLI® and SCM® machines.

RH LH

SAFETY TIPS:



The **TW-200** Torque Wrench is recommended for the proper fastening of clamping nuts (see page 406)

Chucks for "ER32" Precision Collets

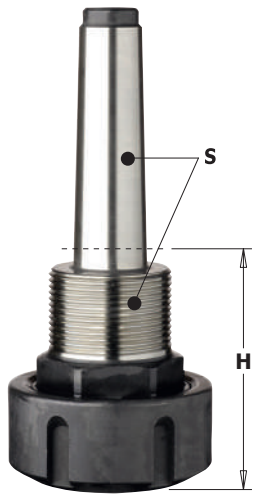

183.000/100

RH LH

S mm	TO BE USED WITH COLLET	H mm		ORDER NO. Right-hand rotation	ORDER NO. Left-hand rotation
MK2/M30x1,5	ER32	62	1	183.000.01	183.000.02
MK3/M30x1,5	ER32	70	1	183.100.01	

MK2/MK3 tapered shank

SAFETY TIPS:

The **TW-200** Torque Wrench is recommended for the proper fastening of clamping nuts (see page 406)

Chucks for "ER32" Precision Collets

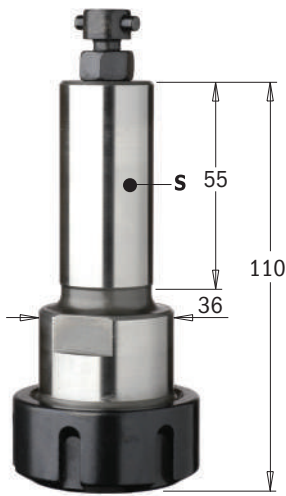

183.400

RH

S mm	TO BE USED WITH COLLET	RETAINING STUD		ORDER NO. Right-hand rotation	
Ø25x55	ER32	LEUCO® P-SYSTEM®	1	183.400.01	

For machines with LEUCO® P-SYSTEM®.

SAFETY TIPS:

The **TW-200** Torque Wrench is recommended for the proper fastening of clamping nuts (see page 406)

Collet Chucks Clamp with MK2 Tapered Shank

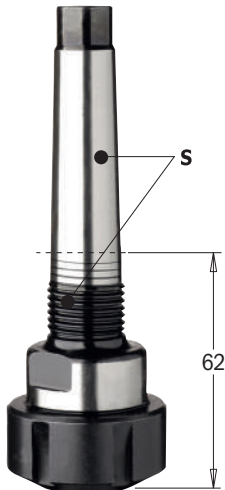

123

RH LH

S		ORDER NO. Right-hand rotation	ORDER NO. Left-hand rotation
MK2/Ø20x14Fx1"	1	123.000.01	123.000.02

Spare parts: **992.123.01** Clamping nut RH
992.123.02 Clamping nut LH
991.123.00 C-spanner

SAFETY TIPS:

The **TW-200** Torque Wrench is recommended for the proper fastening of clamping nuts. The **TW-2836** Hook Insert can be used with this item (see page 406).

Collets for 123 Chucks



124

B mm		ORDER NO.	B mm		ORDER NO.
6	1	124.060.00	10	1	124.100.00
6,35	1	124.064.00	12,7	1	124.120.00
8	1	124.080.00	12,7	1	124.127.00
9,5	1	124.095.00	14	1	124.140.00

Precision Collets "DIN6499"

184

TECHNICAL DETAILS:

Replaceable **Standard Precision 0.015** collets. 0; -0,7mm wide clamping tolerance.
 Replaceable **High Precision 0.005** collets. 0; -1mm wide clamping tolerance.
 Suitable for most conical chucks. Fit most tapered spindle noses.

☐ **Special dimensions available on request.**



RUN-OUT
 This tolerance is guaranteed only on the nominal diameter



ER11

B mm	ORDER NO. STANDARD
2	184.020.11
3	184.030.11
4	184.040.11
5	184.050.11
6	184.060.11

10 pcs. Masterpack



ER16

B mm	B inches	ORDER NO. STANDARD	B mm	B inches	ORDER NO. STANDARD
2		184.020.16	7		184.070.16
3		184.030.16	8	5/16	184.080.16
4		184.040.16	9		184.090.16
5		184.050.16	10		184.100.16
6		184.060.16			

10 pcs. Masterpack



ER20

B mm	B inches	ORDER NO. STANDARD	B mm	B inches	ORDER NO. STANDARD
2	5/16	184.020.20	8	5/16	184.080.20
3		184.030.20	9		184.090.20
4		184.040.20	10		184.100.20
5		184.050.20	11		184.110.20
6		184.060.20	12		184.120.20
6,35	1/4	184.064.20	12,7	1/2	184.127.20
7		184.070.20			

10 pcs. Masterpack



ER25

B mm	B inches	ORDER NO. STANDARD
3		184.030.25
4		184.040.25
5		184.050.25
6		184.060.25
6,35	1/4	184.064.25
8	5/16	184.080.25
9		184.090.25
10		184.100.25
12		184.120.25
12,7	1/2	184.127.25
14		184.140.25
16	5/8	184.160.25

10 pcs. Masterpack



For chucks:

183.000/100/200/250/300/400

ER32



B mm	B inches	ORDER NO. STANDARD	ORDER NO. HIGH new	B mm	B inches	ORDER NO. STANDARD	ORDER NO. HIGH new
3		184.030.00		11		184.110.00	
4		184.040.00	184.040.00H	12		184.120.00	184.120.00H
5		184.050.00		12,7	1/2	184.127.00	
6		184.060.00	184.060.00H	14		184.140.00	
6,35	1/4	184.065.00		15		184.150.00	
7		184.070.00		16	5/8	184.160.00	184.160.00H
8	5/16	184.080.00	184.080.00H	17		184.170.00	
9		184.090.00		18		184.180.00	
9,52	3/8	184.095.00		19	3/4	184.190.00	
10		184.100.00		20		184.200.00	184.200.00H

10 pcs. Masterpack



For chucks:

183.201/211/221/310

ER40



B mm	B inches	ORDER NO. STANDARD	ORDER NO. HIGH new	B mm	B inches	ORDER NO. STANDARD	ORDER NO. HIGH new
3		184.032.00		12		184.122.00	184.122.00H
4		184.042.00		12,7	1/2	184.128.00	
5		184.052.00		14		184.142.00	
6		184.062.00	184.062.00H	16	5/8	184.162.00	184.162.00H
6,35	1/4	184.064.00		18		184.182.00	
7		184.072.00		19	3/4	184.192.00	
8	5/16	184.082.00	184.082.00H	20		184.202.00	184.202.00H
9,52	3/8	184.096.00		25		184.252.00	184.252.00H
10		184.102.00					

10 pcs. Masterpack

Precision Collets "DIN6388"

185

TECHNICAL DETAILS:

Replaceable **Standard Precision 0.015** collets. 0; -0,7mm wide clamping tolerance.
Suitable for most conical chucks. Fit most tapered spindle noses.

Special dimensions available on request.



EOC25

mm	B inches		ORDER NO.	mm	B inches		ORDER NO.
3		10	185.030.00	12		10	185.120.00
4		10	185.040.00	12,7	1/2	10	185.127.00
5		10	185.050.00	14		10	185.140.00
6		10	185.060.00	16	5/8	10	185.160.00
6,35	1/4	10	185.064.00	18		10	185.180.00
8	5/16	10	185.080.00	19	3/4	10	185.191.00
9,5	3/8	10	185.095.00	20		10	185.200.00
10		10	185.100.00	25		10	185.250.00

EOC16

mm	B inches		ORDER NO.	mm	B inches		ORDER NO.
6		10	185.060.16	12		10	185.120.16
8	5/16	10	185.080.16	14		10	185.140.16
10		10	185.100.16	16	5/8	10	185.160.16

Clamping Nuts



992.583 for «ER25»

RH LH

new

DESCRIPTION	D mm	S mm		ORDER NO. Right-hand rotation	ORDER NO. Left-hand rotation
Clamping nut without bearing					
Clamping nut with bearing ER25	42	M32x1,5	1	992.583.01	992.583.02

992.183 for «ER32»

RH LH

DESCRIPTION	D mm	S mm		ORDER NO. Right-hand rotation	ORDER NO. Left-hand rotation
Clamping nut without bearing					
For 183.000/100/200/250/300/400 chucks	50	M40x1,5	1	992.183.01	992.183.02
Clamping nut with bearing					
For 183.000/100/200/250/300/400 chucks	50	M40x1,5	1	992.183.11	992.183.12

992.383 for «ER40»

RH LH

DESCRIPTION	D mm	S mm		ORDER NO. Right-hand rotation	ORDER NO. Left-hand rotation
Clamping nut without bearing					
For 183.201/211/221/310 chucks	63	M50x1,5	1	992.383.01	992.383.02
Clamping nut with bearing					
For 183.201/211/221/310 chucks	63	M50x1,5	1	992.383.11	

992.283 for «EOC25»

RH

DESCRIPTION	D mm	S mm		ORDER NO. Right-hand rotation	
Clamping nut without bearing for chuck 183.320	60	M48x2	1	992.283.01	
Clamping nut with bearing for chuck 183.320	60	M48x2	1	992.283.11	

C-Spanner

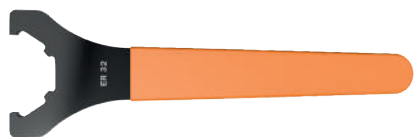

991.183 for «ER32»

DESCRIPTION		ORDER NO.
C-Spanner for "ER32"	1	991.183.00

991.184 for «ER40»

DESCRIPTION		ORDER NO.
C-Spanner for "ER40"	1	991.184.00



991.283 for «DIN6388» and «ER40»

DESCRIPTION		ORDER NO.
C-Spanner for 58-62-65	1	991.283.00

Cap Nuts for CNC Machines

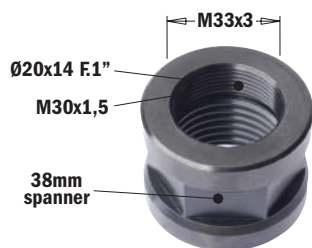

993.0

RH LH

INTERNAL THREAD		ORDER NO. Right-hand rotation	ORDER NO. Left-hand rotation
Ø20x14F1"	1	993.020.01	993.020.02
M30x1,5	1		993.030.02

For machines with M33x3 threaded spindle nose.

ISO30 Retaining Studs



DESCRIPTION	D mm	D ₂ mm	ORDER NO.
For 183.200/201 BIESSE® chucks	8	12,8	995.200.00
For 183.210/211 BIESSE®, OMLAT®, NUOVA BULLERI BREVETTI®, BUSELLATO®, WEEKE®, IMA® chucks	9	13	995.201.00
For 183.220/221 ALBERTI® - MASTERWOOD® chucks	9	12,8	995.202.00
For 183.250/251 SCM® - MORBIDELLI® chucks	6,5	8,5	995.250.00
For LEUCO® P-SYSTEM® 183.400 chucks	M8		995.400.00

Saw Blade Arbor with Parallel Shank

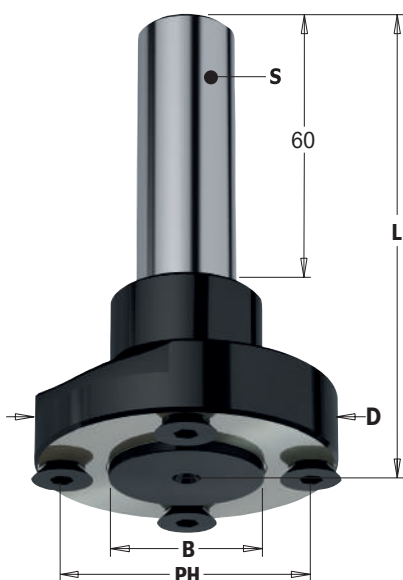

183.410

LH RH

S mm	D mm	B mm	PIN HOLE	L mm		ORDER NO.
20	59	30	4/M6/48	97,5	1	183.410.30

Spare parts: 990.116.00 M6x8,7x12mm TSPEI screw (to use with Plate Thickness ≥ 2,2mm)
 991.067.00 3mm allen key
 991.064.00 4mm allen key



Optional: 990.083.00 M6x8x10mm TSPEI screw (to use with Plate Thickness < 2,2mm)

SAFETY TIPS:

The **TW-006** Torque Screwdriver is recommended for the proper fastening of screws (see page 406).

Grooving saw blades available at page 60 on request.

HSK Chuck for Grooving Blade

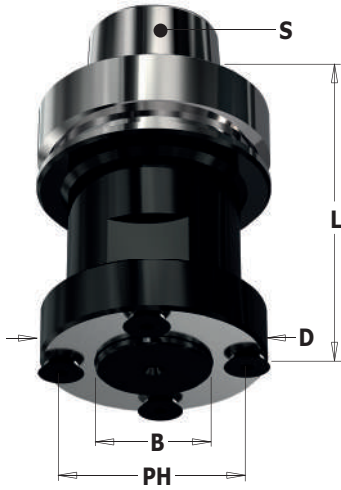

183.420

LH RH

S	D mm	B mm	PIN HOLE	L mm		ORDER NO.
HSK-63F	59	30	4/M6/48	78	1	183.420.30

Spare parts: 990.116.00 M6x8,7x12mm TSPEI screw
991.064.00 4mm allen key



Max saw blade \varnothing 250mm for chuck 183.420.30

Do not exceed maximum RPM indicated on the blade.

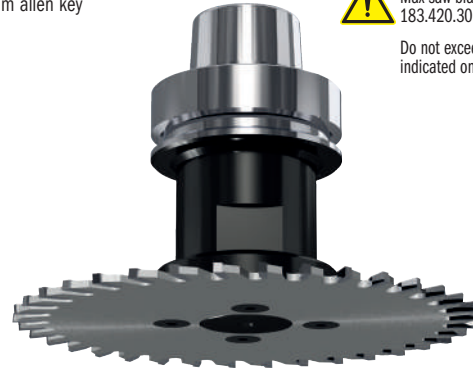

Grooving saw blades available at page 60 on request.

SAFETY TIPS:



The **TW-006** Torque Screwdriver is recommended for the proper fastening of screws (see page 406).

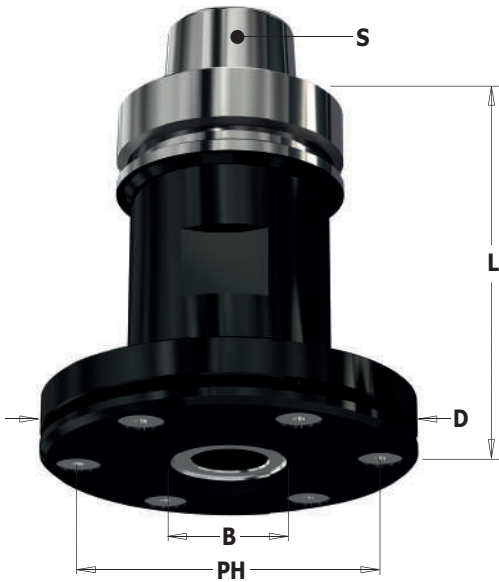

183.421

LH RH

S	D mm	B mm	PIN HOLE	L mm		ORDER NO.
HSK-63F	98	30	6/M6/80	94	1	183.421.30

Spare parts: 990.119.00 M6x12x16mm TSPEI screw
991.064.00 4mm allen key



Max saw blade \varnothing 300mm for chuck 183.421.30

Do not exceed maximum RPM indicated on the blade.

with flange \varnothing 98mm



Grooving saw blades available on request.

SAFETY TIPS:



The **TW-006** Torque Screwdriver is recommended for the proper fastening of screws (see page 406).

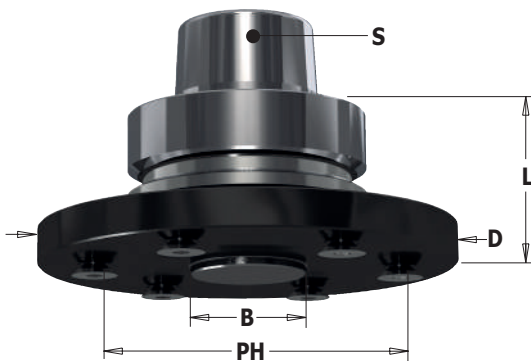

183.422

LH RH

S	D mm	B mm	PIN HOLE	L mm		ORDER NO.
HSK-63F	110	30	6/M6/80	40	1	183.422.30

Spare parts: 990.116.00 M6x8,7x12mm TSPEI screw
991.064.00 4mm allen key



Max saw blade \varnothing 350mm for chuck 183.422.30

Do not exceed maximum RPM indicated on the blade.



Grooving saw blades available on request.

SAFETY TIPS:



The **TW-006** Torque Screwdriver is recommended for the proper fastening of screws (see page 406).

Cutter Arbor with HSK Tapered Shank

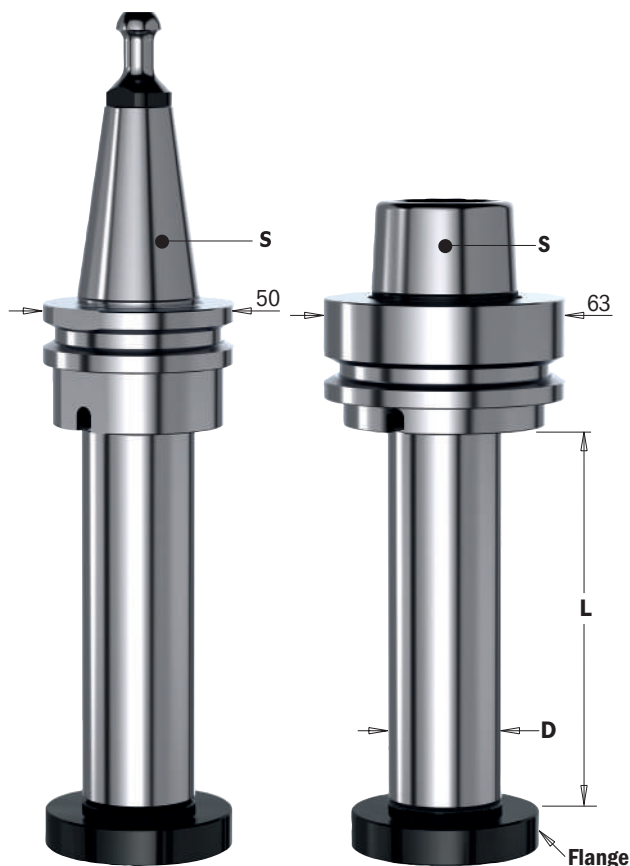

183.260

LH RH

S	DESCRIPTION	D x L mm		ORDER NO.
ISO30	Cutter arbor with ISO30 tapered shank	30x100	1	183.260.00

For BIESSE® machines.

REMARK: special dimensions available on request.

183.360

LH RH

S	DESCRIPTION	D x L mm		ORDER NO.
HSK-63F	Cutter arbor with HSK tapered shank	30x100	1	183.360.00
HSK-63F	Cutter arbor with HSK tapered shank	30x150	1	183.360.10
HSK-63F	Cutter arbor with HSK tapered shank	35x100	1	183.361.00
HSK-63F	Cutter arbor with HSK tapered shank	40x100	1	183.362.00

For HOMAG®, EIMA®, IMA® FROM 9/94, WEEKE®, BIESSE®, SCM®, MORBIDELLI® and MASTERWOOD® machines.

SAFETY TIPS: The **TW-006** Torque Screwdriver is recommended for the proper fastening of screws (see page 406).

Spare Parts for Chucks



DESCRIPTION	ORDER NO.	DESCRIPTION	ORDER NO.
M6x25 TCEI screw	990.098.00	Optional Steel Flange	
Steel flange for with Ø30mm arbors - Male	992.560.30M	For with Ø30mm arbors - Female	992.560.30F
Steel flange for with Ø35mm arbors - Male	992.560.35M	For with Ø35mm arbors - Female	992.560.35F
Steel flange for with Ø40mm arbors - Male	992.560.40M	For with Ø40mm arbors - Female	992.560.40F

Universal Assembly Supports for Chucks



183

SUITABLE FOR	D mm		ORDER NO.
HSK-63, BT40, ISO40 DIN 2080, SK40 DIN 69871, CAPTO® C6	63	1	183-HSK
ISO30, DIN 2080, SK30 DIN 69871, HSK50, CAPTO® C5	50	1	183-ISO*

*Not compatible with chucks **183.250** and **183.251**

CMT now offers new universal assembly supports for HSK-63F and ISO30 chucks. Thanks to the bi-directional roller bearings, which clamp the Left-hand rotation to the flange, the system offers the highest protection to the tool taper and clamps are no longer needed.

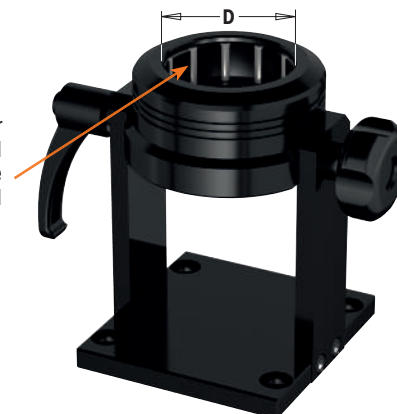



XTREME COATING

THE ULTIMATE TECHNOLOGY FOR INDUSTRIAL CNC TOOLS

DLCS is a modified diamond-like carbon coating with superior load bearing capacity. This hard, durable metal-based finish (chromium nitride) provides an higher hardness surface and enhances the tribological properties of the carbon coating. Its application prevents excessive heat build up which is detrimental to performance. This means cutting tools remain fully effective after every use.

<p>Extreme Coating Hardness >HV 2.500</p> <p>Offers impressive hardness on cutting edges as well as outstanding protection against wear and tear.</p>	<p>Minimal coating thickness µm 2-4</p> <p>This micron thin finish guarantees perfectly sharpened edges for high cutting quality.</p>	<p>Provides the lowest coefficient of friction 0,1-0,2</p> <p>Very good running-in and low friction losses. Reduction of sticking. Ideal for high speeds in Nesting applications.</p>	<p>Optimal resistance to heat build up</p> <p>Reduced overheating. Cutting edges resist excessive wear up to 400°C.</p>
--	---	---	--

BENEFITS



3X
LONGER LIFE
THAN UNCOATED

DLCS CHROME COATING
provides 3 times longer life than uncoated tools!



Test performed in U.S. with 1/2" solid carbide compression spiral bit

- MACHINE:** FELDER® Profit H10 Nested Base/Overhead CNC Router
- WORKING PARAMETERS:** RPM = 18,000 - Feed = 20 mts/minute
- MATERIAL:** 19mm Melamine Chipboard
- APPLICATION:** Nesting Full Dimensioning
- PERFORMANCE:** DLCS coated bit cut 165 melamine panels
Uncoated bit cut 56 melamine panels

FELDER® Profit H10



DLCS coated bit



Melamine Chipboard



Cut quality after 165 panels

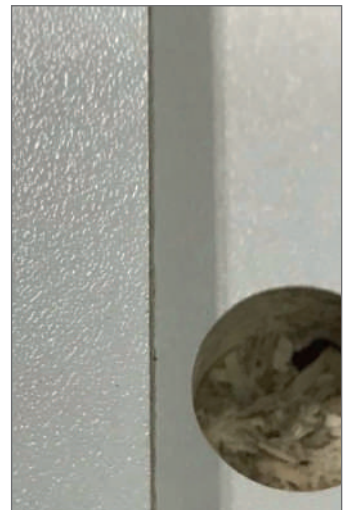

Solid Carbide Upcut & Downcut Spiral Bits



NEW
NEW
NEW

190.41 DLCS Chrome Coating Long Life



D mm	I mm	I ₁ mm	L mm	S mm	Z		ORDER NO. Right-hand rotation
8	32	7	80	8	2+2	10	190.080.41
9,52	28,6	7	76,2	9,52	2+2	10	190.504.41
10	32	7	80	10	2+2	10	190.100.41
10	42	7	90	10	2+2	10	190.101.41
12	42	7	90	12	2+2	10	190.120.41
12	52	7	100	12	2+2	10	190.121.41
12,7	25,4	12	76,2	12,7	2+2	10	190.505.41
12,7	28,6	12	76,2	12,7	2+2	10	190.506.41
12,7	34,9	12	88,9	12,7	2+2	10	190.507.41
12,7	41,3	12	101,6	12,7	2+2	10	190.508.41

...up & downcut mortising bits

9,52	22,2	4,8	76,2	9,52	2+2	10	190.513.41
9,52	25,4	5,2	76,2	9,52	3+3	10	190.813.41
12	25	5,2	83	12	3+3	10	190.320.41
12,7	22,2	5,2	76,2	12,7	2+2	10	190.515.41
12,7	34,9	5,2	88,9	12,7	2+2	10	190.517.41
12,7	28,5	6	76,2	12,7	3+3	10	190.815.41



190



D mm	I mm	I ₁ mm	L mm	S mm	Z		ORDER NO. Right-hand rotation
4	15	5	50	4	1+1	10	190.040.11
5	22	8	60	5	1+1	10	190.050.11
6	22	8	60	6	1+1	10	190.060.11
6,35	22,2	7	63,5	6,35	2+2	10	190.008.11
8	32	7	80	8	2+2	10	190.080.11
9,52	28,6	7	76,2	9,52	2+2	10	190.504.11
10	32	7	80	10	2+2	10	190.100.11
10	42	7	90	10	2+2	10	190.101.11
12	42	7	90	12	2+2	10	190.120.11
12	52	7	100	12	2+2	10	190.121.11
12,7	25,4	12	76,2	12,7	2+2	10	190.505.11
12,7	28,6	12	76,2	12,7	2+2	10	190.506.11
12,7	34,9	12	88,9	12,7	2+2	10	190.507.11
12,7	41,3	12	101,6	12,7	2+2	10	190.508.11
16	55	24	110	16	2+2	10	190.160.11
18	55	30	110	18	2+2	10	190.180.11

...up & downcut mortising bits

9,52	22,2	4,8	76,2	9,52	2+2	10	190.513.11
9,52	25,4	5,2	76,2	9,52	3+3	10	190.813.11
12	25	5,2	83	12	3+3	10	190.320.11
12,7	22,2	5,2	76,2	12,7	2+2	10	190.515.11
12,7	34,9	5,2	88,9	12,7	2+2	10	190.517.11
12,7	28,5	6	76,2	12,7	3+3	10	190.815.11

TECHNICAL DETAILS:

- Premium quality HWM.
- 1+1 spiral cutting edges [Z1+1].
- 2+2 spiral cutting edges [Z2+2].
- 3+3 spiral cutting edges [Z3+3].
- Provide an excellent finish on both the upper and the lower side of the workpiece.

APPLICATION:

used for efficient contour cutting, end-trimming and panel sizing on solid wood, wood composites, plastic materials and laminates at high feed speed. Ensure to properly clamp workpieces. Can be used on machining centres, point-to-point boring machines, CNC routers and hand-held routers equipped with chucks or adapters.



Results shown in this diagram are purely empirical, based merely on informative and hypothetical calculation. Each application may require different parameters in consideration of materials in use and machining conditions. CMT is not responsible for direct, indirect, incidental or consequential damages resulting from any defect, error or failure due to this diagram.

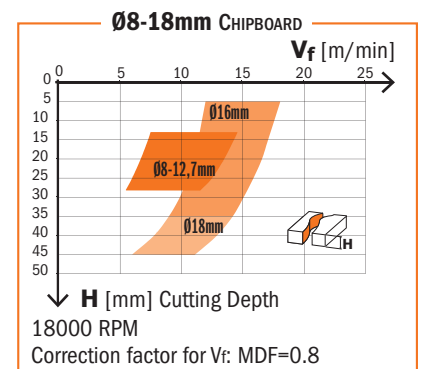
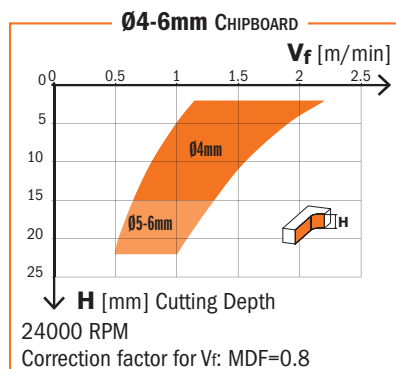



198 Upcut Spiral



D mm	I mm	L mm	S mm		ORDER NO. Right-hand rotation
3	12	50	3	10	198.030.11
3,18	12,7	50,8	6,35	10	198.001.11
4	15	50	4	10	198.040.11
4,76	15,87	50,8	6,35	10	198.005.11
5	17	50	5	10	198.050.11
6	22	60	6	10	198.060.11
6,35	19,05	50,8	6,35	10	198.007.11
6,35	25,4	63,5	6,35	10	198.008.11
8	22	70	8	10	198.080.11
8	32	80	8	10	198.081.11
9,52	28,57	76,2	9,52	10	198.504.11
10	32	70	10	10	198.100.11
10	42	80	10	10	198.101.11
10	52	90	10	10	198.102.11
12	32	83	12	10	198.120.11

TECHNICAL DETAILS:

- Premium quality HWM.
- 1 spiral cutting edge [Z1].
- Provide an excellent finish on the lower side of the workpiece.
- **Upward chip ejection.**

APPLICATION:

used for efficient contour cutting, end-trimming and panel sizing on solid wood, wood composites, plastic materials and laminates at high feed speed. Ensure to properly clamp workpieces.
Can be used on machining centres, point-to-point boring machines, CNC routers and hand-held routers equipped with chucks or adapters.



198 Downcut Spiral



D mm	I mm	L mm	S mm		ORDER NO. Right-hand rotation
6	27	60	6	10	198.660.11

TECHNICAL DETAILS:

- Premium quality HWM.
- 1 spiral cutting edge [Z1].
- Provide an excellent finish on the top side of the workpiece.
- **Upward chip ejection.**

APPLICATION:

used for efficient contour cutting, end-trimming and panel sizing on solid wood, wood composites, plastic materials and laminates at high feed speed. Ensure to properly clamp workpieces.
Can be used on machining centres, point-to-point boring machines, CNC routers and hand-held routers equipped with chucks or adapters.

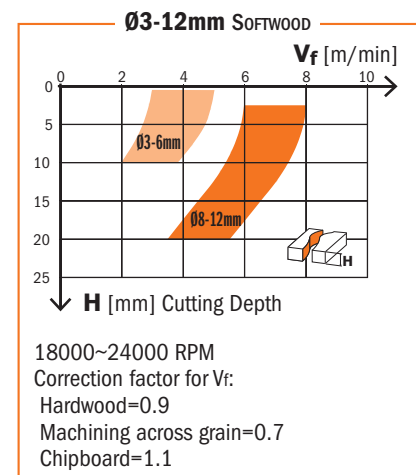
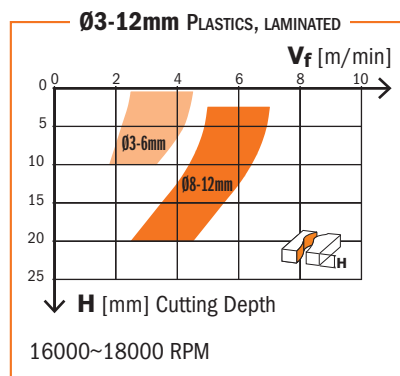

Results shown in this diagram are purely empirical, based merely on informative and hypothetical calculation. Each application may require different parameters in consideration of materials in use and machining conditions. CMT is not responsible for direct, indirect, incidental or consequential damages resulting from any defect, error or failure due to this diagram.



191



D mm	I mm	L mm	S mm		ORDER NO. Right-hand rotation
3	12	50	3	10	191.030.11
3	12	60	6	10	191.630.11
3	12	60	8	10	191.830.11
3,18	12,7	50,8	6,35	10	191.001.11
3,5	12	60	6	10	191.635.11
3,97	12,7	50,8	6,35	10	191.003.11
4	15	50	4	10	191.040.11
4	15	60	6	10	191.640.11
4	15	60	8	10	191.840.11
4,76	19,05	50,8	6,35	10	191.005.11
5	17	50	5	10	191.050.11
5	17	60	6	10	191.650.11
5	17	60	8	10	191.850.11
6	27	70	6	10	191.060.11
6	27	70	8	10	191.860.11
6,35	19,05	50,8	6,35	10	191.007.11
6,35	25,4	63,5	6,35	10	191.008.11
7	32	80	8	10	191.870.11
7,94	25,4	76,2	12,7	10	191.501.11
8	22	70	8	10	191.080.11
8	32	80	8	10	191.081.11
8	42	90	8	10	191.082.11
9	32	83	12	10	191.890.11
9,52	31,75	82,5	12,7	10	191.503.11
10	32	80	8	10	191.800.11
10	32	80	10	10	191.100.11
10	32	83	12	10	191.900.11
10	42	90	10	10	191.101.11
10	42	90	12	10	191.901.11
12	35	83	8	10	191.820.11
12	35	83	12	10	191.120.11
12	42	90	12	10	191.121.11
12	52	100	12	10	191.122.11
12,7	31,75	76,2	12,7	10	191.505.11
12,7	38,1	88,9	12,7	10	191.506.11
12,7	50,8	101,6	12,7	10	191.507.11
14	50	110	14	1	191.140.11
16	55	110	16	1	191.160.11
16	35	90	16	1	191.161.11
16	72	120	16	1	191.165.11
20	72	120	20	1	191.200.11

Ø12-14mm PLASTICS, LAMINATED

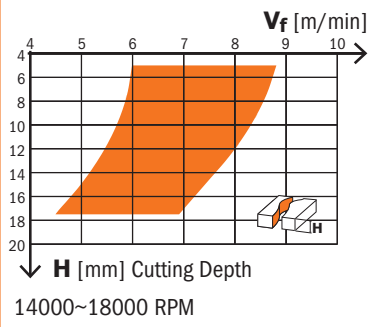

Ø12-20mm SOFTWOOD

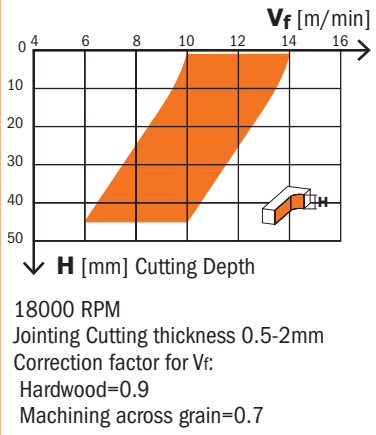

TECHNICAL DETAILS:

- Premium quality HWM.
- 2 spiral cutting edges [Z2].
- Provide an excellent finish on the lower side of the workpiece.
- **Upward chip ejection.**

APPLICATION:

used for efficient contour cutting, end-trimming and panel sizing on solid wood, wood composites, plastic materials and laminates at high feed speed. Ensure to properly clamp workpieces. Can be used on machining centres, point-to-point boring machines, CNC routers and hand-held routers equipped with chucks or adapters.



Results shown in this diagram are purely empirical, based merely on informative and hypothetical calculation. Each application may require different parameters in consideration of materials in use and machining conditions. CMT is not responsible for direct, indirect, incidental or consequential damages resulting from any defect, error or failure due to this diagram.

Solid Carbide Downcut Spiral Bits

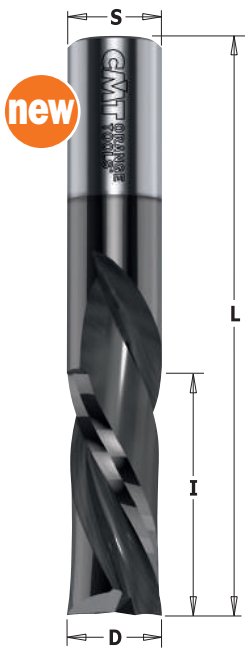

new



192.41 DLCS Chrome Coating Long Life



D mm	I mm	L mm	S mm	Box	ORDER NO. Right-hand rotation
6,35	19,05	50,8	6,35	10	192.007.41
6,35	25,4	63,5	6,35	10	192.008.41
9,52	31,75	82,5	12,7	10	192.503.41
12,7	31,75	76,2	12,7	10	192.505.41
12,7	38,1	88,9	12,7	10	192.506.41
12,7	50,8	101,6	12,7	10	192.507.41

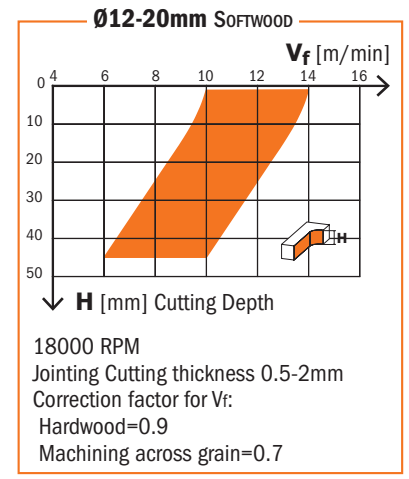
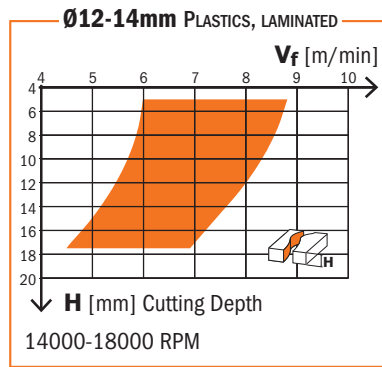

Results shown in this diagram are purely empirical, based merely on informative and hypothetical calculation. Each application may require different parameters in consideration of materials in use and machining conditions. CMT is not responsible for direct, indirect, incidental or consequential damages resulting from any defect, error or failure due to this diagram.



192



D mm	I mm	L mm	S mm	Box	ORDER NO. Right-hand rotation
3	12	50	3	10	192.030.11
3	12	60	6	10	192.630.11
3	12	60	8	10	192.830.11
3,18	12,7	50,8	6,35	10	192.001.11
3,97	12,7	50,8	6,35	10	192.003.11
4	15	50	4	10	192.040.11
4	15	60	6	10	192.640.11
4	15	60	8	10	192.840.11
4,76	19,05	50,8	6,35	10	192.005.11
5	17	50	5	10	192.050.11
5	17	60	6	10	192.650.11
5	17	60	8	10	192.850.11
6	27	70	6	10	192.060.11
6	27	70	8	10	192.860.11
6,35	19,05	50,8	6,35	10	192.007.11
6,35	25,4	63,5	6,35	10	192.008.11
7,94	25,4	76,2	12,7	10	192.501.11
8	22	70	8	10	192.080.11
8	32	80	8	10	192.081.11
8	42	90	8	10	192.082.11
9,52	31,75	82,5	12,7	10	192.503.11
10	32	80	8	10	192.800.11
10	32	80	10	10	192.100.11
10	42	90	10	10	192.101.11
10	32	83	12	10	192.900.11
12	35	83	8	10	192.820.11
12	35	83	12	10	192.120.11
12,7	31,75	76,2	12,7	10	192.505.11
12,7	38,1	88,9	12,7	10	192.506.11
12,7	50,8	101,6	12,7	10	192.507.11
14	52	110	14	1	192.140.11
16	55	110	16	1	192.160.11

TECHNICAL DETAILS:

- Premium quality HWM.
- 2 spiral edges [Z2].
- Provide an excellent finish on the upper side of the workpiece.
- **Downward chip ejection.**

APPLICATION:

used for efficient contour cutting, end-trimming and panel sizing on solid wood, wood composites, plastic materials and laminates at high feed speed. Ensure to properly clamp workpieces. Can be used on machining centres, point-to-point boring machines, CNC routers and hand-held routers equipped with chucks or adapters.

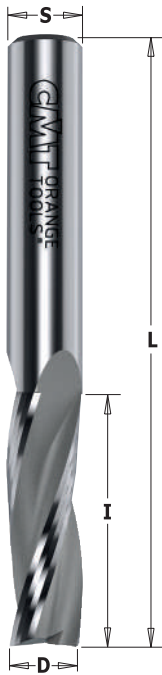

193



D mm	I mm	L mm	S mm		ORDER NO. Right-hand rotation	ORDER NO. Left-hand rotation
8	32	80	8	10	193.081.11	193.081.12
10	32	80	10	10	193.100.11	193.100.12
10	42	90	10	10	193.101.11	
12	35	83	12	10	193.120.11	193.120.12
12	42	90	12	10	193.121.11	
12	52	100	12	10	193.122.11	
14	58	110	14	1	193.140.11	
16	55	110	16	1	193.160.11	193.160.12
16	35	90	16	1	193.161.11	
16	72	120	16	1	193.165.11	
18	55	110	18	1	193.180.11	
20	60	120	20	1	193.200.11	193.200.12
20	70	120	20	1	193.201.11	
20	102	165	20	1	193.202.11	

NEW

TECHNICAL DETAILS:

- Premium quality HWM.
- 3 spiral cutting edges [Z3].
- Provide an excellent finish on the lower side of the workpiece.
- **Upward chip ejection.**

APPLICATION:

used for efficient contour cutting, end-trimming and panel sizing on solid wood, wood composites, plastic materials and laminates at high feed speed. Ensure to properly clamp workpieces. Can be used on machining centres, point-to-point boring machines, CNC routers and hand-held routers equipped with chucks or adapters.

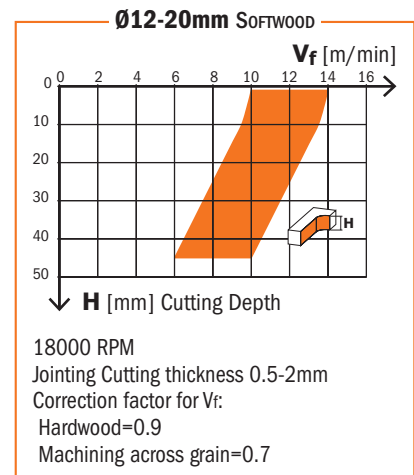
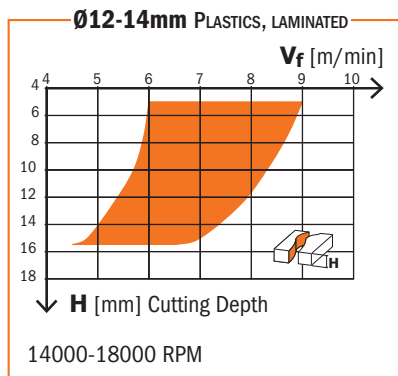

Results shown in this diagram are purely empirical, based merely on informative and hypothetical calculation. Each application may require different parameters in consideration of materials in use and machining conditions. CMT is not responsible for direct, indirect, incidental or consequential damages resulting from any defect, error or failure due to this diagram.

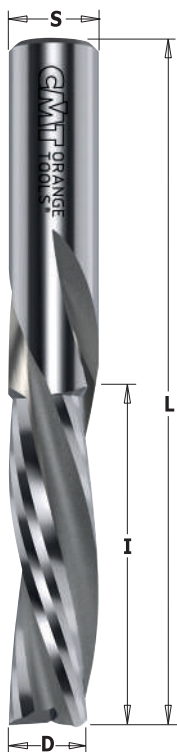

194



D mm	I mm	L mm	S mm		ORDER NO. Right-hand rotation	ORDER NO. Left-hand rotation
10	32	80	10	10	194.100.11	
10	42	90	10	10	194.101.11	
12	35	83	12	10	194.120.11	194.120.12
12	42	90	12	10	194.121.11	
14	50	110	14	1	194.140.11	
16	55	110	16	1	194.160.11	194.160.12
16	35	90	16	1	194.161.11	
18	55	110	18	1	194.180.11	
20	60	120	20	1	194.200.11	194.200.12
20	72	120	20	1	194.201.11	
20	102	165	20	1	194.202.11	

TECHNICAL DETAILS:

- Premium quality HWM.
- 3 spiral cutting edges [Z3].
- Provide an excellent finish on the upper side of the workpiece.
- **Downward chip ejection.**

APPLICATION:

used for efficient contour cutting, end-trimming and panel sizing on solid wood, wood composites, plastic materials and laminates at high feed speed. Ensure to properly clamp workpieces. Can be used on machining centres, point-to-point boring machines, CNC routers and hand-held routers equipped with chucks or adapters.

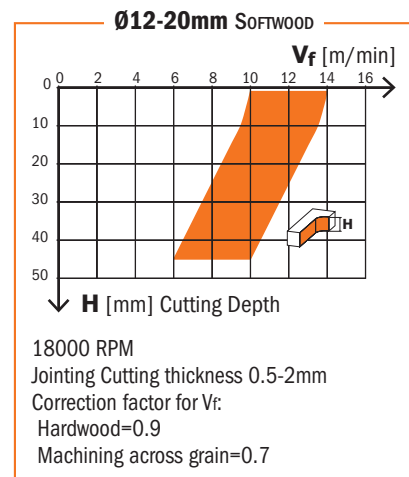
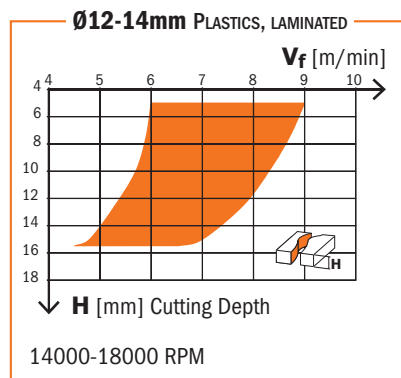

Results shown in this diagram are purely empirical, based merely on informative and hypothetical calculation. Each application may require different parameters in consideration of materials in use and machining conditions. CMT is not responsible for direct, indirect, incidental or consequential damages resulting from any defect, error or failure due to this diagram.

Solid Carbide Upcut Spiral Bits with Chip-Breaker



195



D mm	I mm	L mm	S mm		ORDER NO. Right-hand rotation	ORDER NO. Left-hand rotation
8	32	80	8	10	195.081.11	195.081.12
8	42	90	8	10	195.082.11	
10	32	80	10	10	195.100.11	195.100.12
10	42	90	10	10	195.101.11	
12	35	83	12	10	195.120.11	195.120.12
12	42	90	12	10	195.121.11	
12	52	100	12	10	195.122.11	
12,7	38,1	88,9	12,7	10	195.506.11	
14	58	110	14	1	195.140.11	
16	55	110	16	1	195.160.11	195.160.12
16	35	90	16	1	195.161.11	
16	72	120	16	1	195.165.11	
18	55	110	18	1	195.180.11	
20	60	120	20	1	195.200.11	195.200.12
20	72	120	20	1	195.201.11	
20	102	165	20	1	195.202.11	

TECHNICAL DETAILS:

- Premium quality HWM.
- 3 spiral cutting edges [Z3R].
- Chip breaker teeth.
- Max 0.3mm tooth depth.
- Provide an excellent finish on the lower side of the workpiece.
- **Upward chip ejection.**

APPLICATION:

used for efficient contour cutting, end-trimming and panel sizing on solid wood, wood composites, plastic materials and laminates at high feed speed. Ensure to properly clamp workpieces. Can be used on machining centres, point-to-point boring machines, CNC routers and hand-held routers equipped with chucks or adapters.

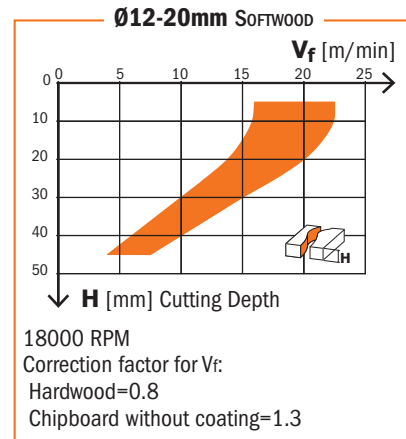
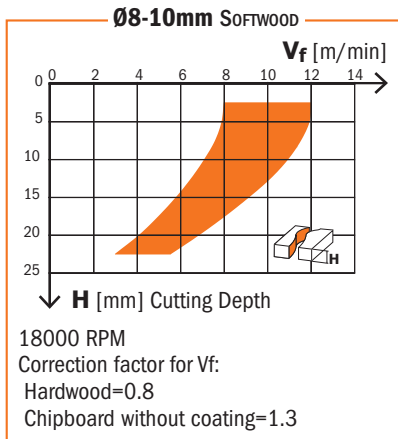

Results shown in this diagram are purely empirical, based merely on informative and hypothetical calculation. Each application may require different parameters in consideration of materials in use and machining conditions. CMT is not responsible for direct, indirect, incidental or consequential damages resulting from any defect, error or failure due to this diagram.

Solid Carbide Upcut Spiral Bits

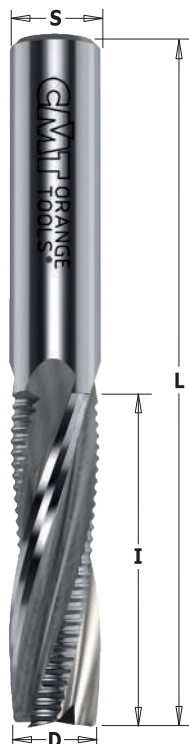

197



D mm	I mm	L mm	S mm		ORDER NO. Right-hand rotation	
12	42	90	12	10	197.121.11	
14	50	110	14	1	197.140.11	
16	55	110	16	1	197.160.11	
16	35	90	16	1	197.161.11	
18	55	110	18	1	197.180.11	
20	60	120	20	1	197.200.11	
20	72	120	20	1	197.201.11	

TECHNICAL DETAILS:

- Premium quality HWM.
- 4 spiral cutting edges (2 with chip-breaker) [Z2+2R].
- Max 0.1mm tooth depth.
- Provide excellent finish on the lower side of the workpiece.
- **Upward chip ejection.**

APPLICATION:

used for efficient contour cutting, end-trimming and panel sizing on solid wood and wood composites. Can be used on machining centres, point-to-point boring machines, CNC routers and hand-held routers equipped with chucks or adapters.



The special 4 flute design (Z2 finishing + Z2R with chipbreaker) allows high speed with excellent finish on the workpiece.

Solid Carbide Downcut Spiral Bits with Chip-Breaker

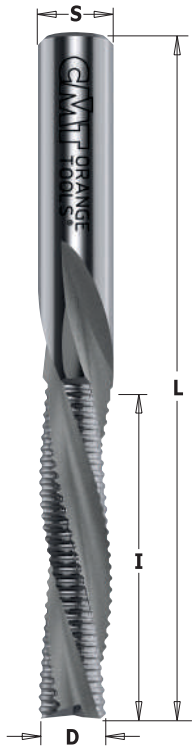

196



D mm	I mm	L mm	S mm		ORDER NO. Right-hand rotation	ORDER NO. Left-hand rotation
8	32	80	8	10	196.081.11	
10	42	90	10	10	196.101.11	
12	35	83	12	10	196.120.11	196.120.12
12	42	90	12	10	196.121.11	
12	52	100	12	10	196.122.11	
12,7	38,1	88,9	12,7	10	196.506.11	
14	50	110	14	1	196.140.11	
16	55	110	16	1	196.160.11	196.160.12
18	55	110	18	1	196.180.11	
20	60	120	20	1	196.200.11	
20	72	120	20	1	196.201.11	

TECHNICAL DETAILS:

- Premium quality HWM.
- 3 spiral cutting edges [Z3R].
- Chip breaker teeth.
- Max 0.3mm tooth depth.
- Provide excellent finish on the upper side of the workpiece.
- **Downward chip ejection.**

APPLICATION:

used for efficient contour cutting, end-trimming and panel sizing on solid wood, wood composites, plastic materials and laminates at high feed speed. Ensure to properly clamp workpieces. Can be used on machining centres, point-to-point boring machines, CNC routers and hand-held routers equipped with chucks or adapters.

Ø8-10mm SOFTWOOD

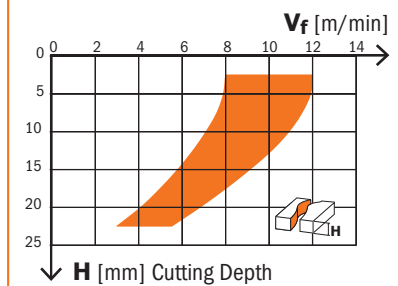

18000 RPM
Correction factor for Vr:
Hardwood=0.8
Chipboard without coating=1.3

Ø12-20mm SOFTWOOD

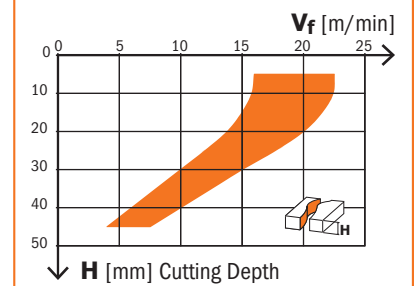

18000 RPM
Correction factor for Vr:
Hardwood=0.8
Chipboard without coating=1.3



Results shown in this diagram are purely empirical, based merely on informative and hypothetical calculation. Each application may require different parameters in consideration of materials in use and machining conditions. CMT is not responsible for direct, indirect, incidental or consequential damages resulting from any defect, error or failure due to this diagram.

Solid Carbide Upcut & Downcut Spiral Bit with DLCS Chrome Coating



190.04



D mm	d mm	I mm	L mm	S mm	Z		ORDER NO. Right-hand rotation
9,8	7	25	83	12	2+2	10	190.001.04

LAMELLO® P-SYSTEM® components can be crafted on a CNC machining center. Groovework is carried out along the edge workpiece with a spiral cutter coated with DLCS for long life.

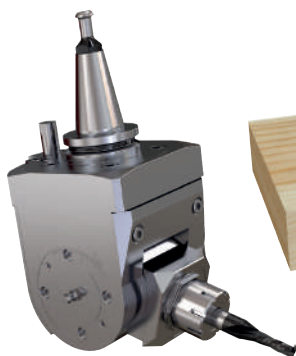

For use only on 5 axis CNC machines.



1



2



3



4



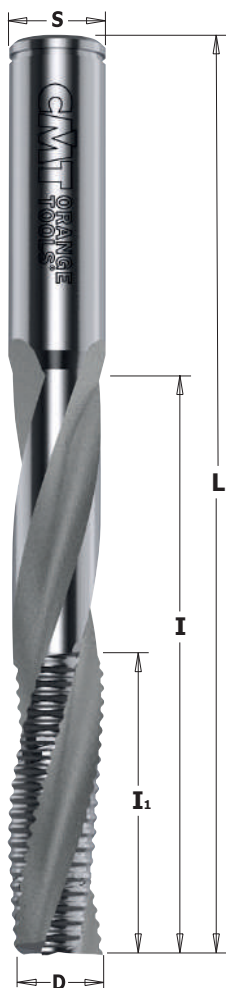

195



D mm	I mm	I ₁ mm	L mm	S mm		ORDER NO. Right-hand rotation
With Chip-Breaker						
14	95*	45	150	14	1	195.142.11
14	125*	45	170	14	1	195.144.11
16	95*	45	150	16	1	195.162.11
16	120*	50	170	16	1	195.164.11
18	95*	45	150	18	1	195.182.11
Without Chip-Breaker						
16	95*	45	150	16	1	193.162.11

* The maximum cutting length is achieved in 2-3 passes.

TECHNICAL DETAILS:

- Premium quality HWM.
- 3 spiral cutting edges [Z3] and [Z3R].
- Max 0.3mm tooth depth.
- Provide an excellent finish on the lower side of the workpiece.
- Seat for seeger ring (*not included*).
- **Upward chip ejection.**

APPLICATION:

used for efficient contour cutting, end-trimming and panel sizing on solid wood, wood composites, plastic materials and laminates at high feed speed. Ensure to properly clamp workpieces. Can be used on machining centres, point-to-point boring machines, CNC routers and hand-held routers equipped with chucks or adapters.

GUIDE FOR MACHINING DEEP SLOTS

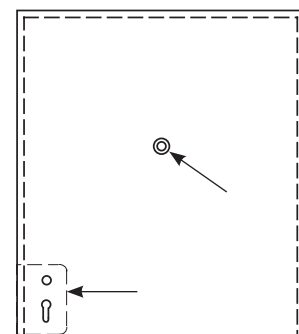
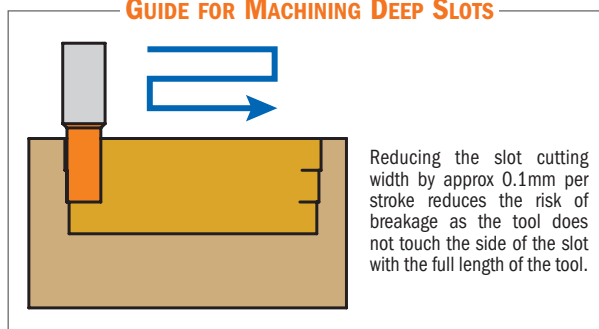

Solid Carbide Upcut Spiral Bits with Chip-Breaker for 60° V-Point Locksets



195.143/163

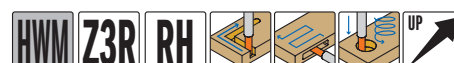

D mm	I mm	L mm	S mm		ORDER NO. Right-hand rotation
14	58	110	14	1	195.143.11
16	55	110	16	1	195.163.11

Solid Carbide Upcut Spiral Bits without Chip-Breaker for 60° V-Point Locksets

191.143/163

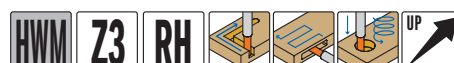

D mm	I mm	L mm	S mm		ORDER NO. Right-hand rotation
14	50	110	14	1	191.143.11
16	55	110	16	1	191.163.11

TECHNICAL DETAILS:

- Premium quality HWM.
- 3 spiral cutting edges [Z3].
- Provide an excellent finish on the lower side of the workpiece.
- **Upward chip ejection.**

APPLICATION:

used for efficient contour cutting, end-trimming and panel sizing on solid wood, wood composites, plastic materials and laminates at high feed speed. Ensure to properly clamp workpieces. Can be used on machining centres, CNC routers and hand-held routers equipped with chucks or adapters.

Spiral Bits with Insert Knives & Chip-Breaker for Locksets

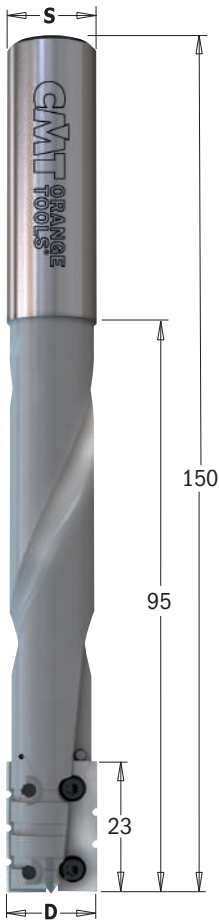

662

D mm	I mm	L mm	S mm		ORDER NO. Right-hand rotation
16	23/95*	150	16	1	662.160.11



Spare parts

790.230.2R - 790.230.3R	990.082.00	991.063.00

Spare parts: **790.230.2R** 23x7x1.5mm 2-RT HWM K2020 knives (Minimum 10 pieces or multiple)
790.230.3R 23x7x1.5mm 3-RT HWM K2020 knives (Minimum 10 pieces or multiple)

* The 95mm length is achieved in 4-5 passes.

TECHNICAL DETAILS:

- DENSIMET® high density tungsten alloy for low-vibration.
- 2 cutting edges [Z2R] with chip-breakers

APPLICATION:

used for efficient contour cutting, end-trimming and panel sizing on solid wood, wood composites, plastic materials and laminates at high feed speed. Ensure to properly clamp workpieces. Can be used on machining centres, point-to-point boring machines, CNC routers and hand-held routers equipped with chucks or adapters. Cost-effective solution with respect to brazed and spiral in tungsten carbide.

SAFETY TIPS:

The **TW-006** Torque Screwdriver is recommended for the proper fastening of screws (see page 406).

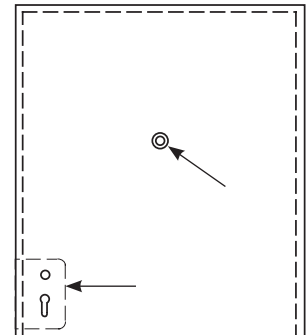
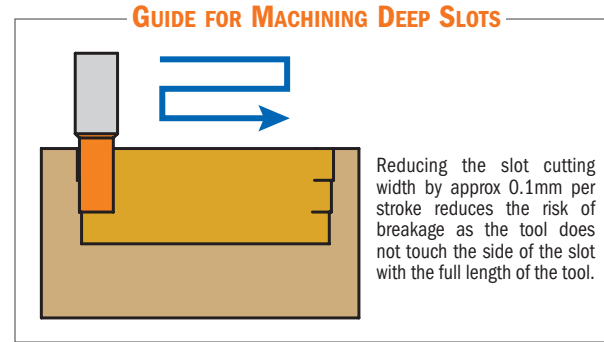

Upcut Spiral Bits with Chipbreaker for Glue-Laminated Wooden Beams



195

D mm	I mm	L mm	S mm		ORDER NO. Right-hand rotation
□ 30	170	235	30	1	Y195.300.51
40	165	235	30	1	195.400.51
50	215	295	30	1	195.500.51

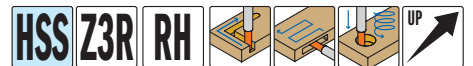

□ On request

Available by special request bits without chip breaker, with left-hand rotation and/or custom dimensions.

TECHNICAL DETAILS:

- High speed cobalt steel.
- 3 upcut spiral cutting edges with chipbreaker [Z3R].
- Resharpenable cutters.
- Max 6000~10000 RPM.
- Maximum feed speed 2m/minute.
- **Upward chip ejection.**

APPLICATION:

used for cutting, copying, and routing on glue-laminated wooden beams. For use on HUNDEGGER® machines.

Solid Carbide Upcut 2D/3D Carving Tapered Ball Nose Spiral Bits



152



D mm	R mm	A	I mm	L mm	S mm	Z		ORDER NO. Right-hand rotation
0,8	0,4	5,5°	25	70	6	3	10	152.060.082
0,8	0,4	6,2°	25,4	76,2	6,35	3	10	152.064.082
1,6	0,8	4,5°	25	70	6	3	10	152.060.162
1,6	0,8	5,4°	25,4	76,2	6,35	3	10	152.064.162
1,6	0,8	5,5°	30	80	8	3	10	152.080.163
2	1	3°	80	120	12	2	10	152.120.208
3,2	1,6	2,5°	30	70	6	3	10	152.060.323
3,2	1,6	3,6°	25,4	76,2	6,35	3	10	152.064.322
3,2	1,6	2,5°	50	90	8	3	10	152.080.325
6	3	3°	50	100	12	2	10	152.120.605
6,4	3,2	3°	50,8	101,6	12,7	2	10	152.127.635

TECHNICAL DETAILS:

- Premium quality HWM.
- Upcut spiral cutting edges [Z2/Z3].
- **Excellent finish on the lower side of the work piece.**
- Upward chip ejection.

APPLICATION:

- specially designed for 2D and 3D CNC profiling and carving in plastic, aluminum & wood for several uses like:
- A perfect bit for 3D carving
 - Precision 2D and 3D large scale carving
 - Great for deep profiling
 - Dimensional signage
 - 3D millwork
 - 2D and 3D contouring, profiling, modeling and pattern making for cabinetry, sign making, furniture making and jewelry mold making
 - Perfect for model-makers on large 3D milling profiles in abrasive EPS foam and other materials.
 - **Ideal on aluminum, plastic and wood-based materials.**

EXCELLENCE FOR CUTTING

- Acrylonitrile-Butadiene-Styrene (ABS)
- Acrylic
- Acrylic Stone
- Aluminum
- Brass
- Bronze
- Composite
- Copper
- Ethylene-vinyl Acetate Foam (EVA)
- Expanded Polypropylene (EPP)
- Expanded Polystyrene Foam (EPS)
- Extruded Polystyrene Foam (XPS)
- Fiberglass
- Fiberglass PCB Board
- Foam Board

- Graphite
- HDPE
- HDU
- 20lbs High Density Urethane
- MDF/HDF
- Phenolics
- Phenolic Composites
- Plastics
- Poly (methyl methacrylate) (PMMA)
- Polyethylene Foam
- Polyurethane Foam
- PVC
- PVC Foam Board
- Sign Board
- Sign Foam

- Titanium
- Tooling Board
- Wood
- XPE (Cross Linked Polyethylene) Foam

ALSO EXCELLENCE FOR

- CORIAN®
- COROPLAST®
- DIBOND®
- ETHAFOAM®
- LEXAN®
- PALFOAM®
- POLYLAM®

TIPS FOR MILLING PLASTICS

- pay attention to heat input
- pay attention to chip-loads when using small diameters
- use air-blast to keep chip away and cooling the tool

Round Nose Solid Carbide Upcut Spiral Bits



199



D mm	R mm	I mm	L mm	S mm		ORDER NO. Right-hand rotation
3,18	1,6	12,7	50,8	6,35	10	199.001.11
6	3	27	70	6	10	199.060.11
6,35	3,18	25,4	63,5	6,35	10	199.008.11
8	4	32	80	8	10	199.081.11
9,52	4,76	28,57	76,2	9,52	10	199.504.11
10	5	32	80	10	10	199.100.11
12	6	35	80	12	10	199.120.11
12,7	6,35	31,75	76,2	12,7	10	199.505.11
15,88	7,94	57,15	109,5	15,88	1	199.509.11
16	8	55	110	16	1	199.160.11
19,05	9,52	57,15	109,5	19,05	1	199.511.11

TECHNICAL DETAILS:

- Premium quality HWM.
- 2 upcut spiral cutting edges [Z2].
- Excellent finish on the lower side of the work piece.
- **Upward chip ejection.**

APPLICATION:

used for efficient contour cutting, end-trimming and panel sizing on solid wood, wood composites, plastic materials and laminates at high feed speed. Ensure to properly clamp workpieces. Can be used on machining centres, point-to-point boring machines, CNC routers and hand-held routers equipped with chucks or adapters. Cost-effective solution with respect to brazed and spiral in tungsten carbide.

Solid Surface and Fiberglass Bit with DLCS Chrome Coating



151 XTREME PERFORMANCE



D mm	I mm	L mm	S mm		ORDER NO. Right-hand rotation
6	19	60	6	10	151.060.19E
6,35	25,4	63,5	6,35	10	151.064.25E
8	25	60	8	10	151.080.25E
12	25	75	12	10	151.120.25E
12,7	38	89	12,7	10	151.127.38E

TECHNICAL DETAILS:

- Premium quality HWM
- Special positively ground cutting edge sharpening for excellent finish

APPLICATION:

used for efficient contour cutting, end-trimming and panel sizing on glass fiber and fiberglass, phenolic and composite material.
For use on machining centres, point-to-point boring machines, CNC routers and hand-held routers equipped with chucks or adapters.



DLCS CHROME COATING:

- Superb wear resistance
- Better chip clearance
- Superior cutting quality
- Less overheating
- More productivity



DLCS CHROME COATING provides 3 times longer life than uncoated tools!

Solid Surface and Fiberglass Bit with DLCS Chrome Coating



151 XTREME PERFORMANCE



D mm	I mm	L mm	S mm		ORDER NO. Right-hand rotation
6	19	60	6	10	151.060.19D
6,35	25,4	63,5	6,35	10	151.064.25D
8	25	60	8	10	151.080.25D
12	25	75	12	10	151.120.25D
12,7	38	89	12,7	10	151.127.38D

TECHNICAL DETAILS:

- Premium quality HWM
- Special positively ground cutting edge sharpening for excellent finish

APPLICATION:

used for efficient contour cutting, end-trimming and panel sizing on fiberglass, glass fiber phenolic and composite material. The 135° tooth geometry allows vertical feeding minimizing the bending of the workpiece. To be used on machining centres, point-to-point boring machines, CNC routers and hand-held routers equipped with chucks or adapters.



DLCS CHROME COATING:

- Superb wear resistance
- Better chip clearance
- Superior cutting quality
- Less overheating
- More productivity

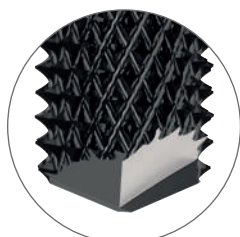

Sharpening 135°



DLCS CHROME COATING provides 3 times longer life than uncoated tools!

DP - Router Cutters with Negative Shear Angle

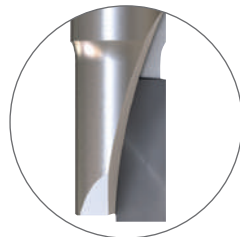

Negative Cutting Edge

141 (HWM tool body)



D mm	I mm	L mm	S mm	Z		ORDER NO. Right-hand rotation
6	10	60	6	1 neg.	1	141.260.61
8	15	65	8	1 neg.	1	141.280.61
10	15	65	10	1 neg.	1	141.300.61
12	20	70	12	1 neg.	1	141.320.61

TECHNICAL DETAILS:

- Special super-micrograin carbide formulation
- Straight cutting edge.
- DP (H3).
- Resharpener cutter (max 3 times).
- Feed speed on MDF 3-4 m/min for cutter Ø6 and Ø8mm and 4-5m/minute for Ø10 and Ø12mm

APPLICATION:

for boring, contour cutting and panel sizing on veneered and wood-based materials. For use on machining centers, point to point boring machines and CNC pantographs equipped with adaptors and chucks.

DP - Router Cutters



* Construction Z1+1
for 141.101.61 item

141



D mm	I mm	L mm	S mm	Z		ORDER NO. Right-hand rotation
6	8	65	12x40	1	1	141.060.61
8	12	65	12x40	1	1	141.080.61
*10	22	75	12x40	1+1	1	141.101.61

TECHNICAL DETAILS:

- Super strength steel.
- DP cutting edge (H2,5).
- HW plunging tip for diagonal plunge-cutting.
- Resharpener cutter (max 3 times).
- Max feed speed 4 m/min.

APPLICATION:

for boring, contour cutting and panel sizing on veneered and wood-based materials. For use on machining centers, point to point boring machines and CNC pantographs equipped with adaptors and chucks.

DP - Router Cutters with Shear Angle



140

D mm	I mm	L mm	S mm	Z		ORDER NO. Right-hand rotation
10	25	72	12x40	1+1 (3 DP+1 HW)	1	140.03956
12	27	75	12x40	1+1 (3 DP+1 HW)	1	140.120.61
12	35	85	12x40	1+1 (4 DP+1 HW)	1	140.121.61
12,7	27	75	12,7x40	1+1 (3 DP+1 HW)	1	140.127.61
12,7	35	85	12,7x40	1+1 (4 DP+1 HW)	1	140.128.61
15,87	27	85	15,87x50	1+1 (3 DP+1 HW)	1	140.158.61
15,87	45	103	15,87x50	1+1 (5 DP+1 HW)	1	140.159.61
16	27	85	16x50	1+1 (3 DP+1 HW)	1	140.160.61
16	35	93	16x50	1+1 (4 DP+1 HW)	1	140.161.61
18	27	85	20x50	1+1 (3 DP+1 HW)	1	140.180.61
18	35	95	20x50	1+1 (4 DP+1 HW)	1	140.181.61
18	45	105	20x50	1+1 (5 DP+1 HW)	1	140.182.61
19,05	27	85	19,05x50	1+1 (3 DP+1 HW)	1	140.190.61
19,05	45	105	19,05x50	1+1 (5 DP+1 HW)	1	140.192.61
20	27	85	20x50	1+1 (3 DP+1 HW)	1	140.200.61
20	35	95	20x50	1+1 (4 DP+1 HW)	1	140.201.61
20	45	105	20x50	1+1 (5 DP+1 HW)	1	140.202.61
20	55	115	20x50	1+1 (6 DP+1 HW)	1	140.203.61

CARACTÉRISTIQUES TECHNIQUES:

- Super strength steel.
- Shear angle. - DP cutting edge (H2,5).
- HW plunging tip for diagonal plunge-cutting.
- Resharpeable (max 3 times).
- Max feed speed 5 m/min.

UTILISATION: for contour cutting and panel sizing on hard and abrasive materials such as laminates, MDF and melamine. For use on machining centers, point to point boring machines and CNC pantographs equipped with adaptors and chucks.



Results shown in this diagram are purely empirical, based merely on informative and hypothetical calculation. Each application may require different parameters in consideration of materials in use and machining conditions. CMT is not responsible for direct, indirect, incidental or consequential damages resulting from any defect, error or failure due to this diagram.

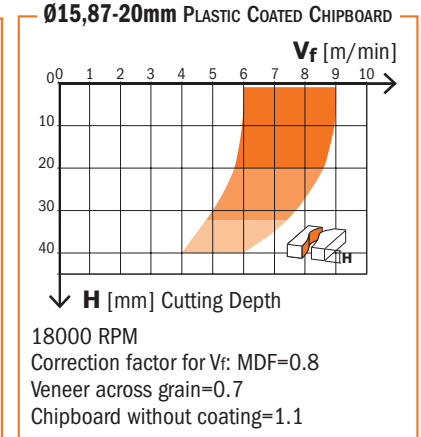
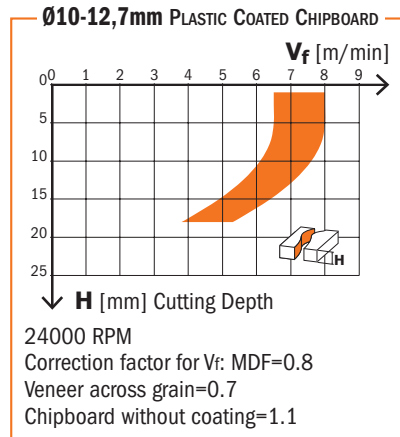

DP - Router Cutters with 45° Shear Angle

140



D mm	I mm	L mm	S mm	Z		ORDER NO. Right-hand rotation
20	25	85	20x50	1+1 (6 DP+1 HW)	1	140.720.61
20	35	95	20x50	1+1 (8 DP+1 HW)	1	140.721.61
20	45	105	20x50	1+1 (9 DP+1 HW)	1	140.722.61

TECHNICAL DETAILS:

- Super strength steel.
- Diamond cutting edges featuring 45° shear angle (H4).
- HW plunging tip for plunge cutting.
- Resharpenable cutters (max 8-9 times).
- Max feed speed 5 m/min.

APPLICATION:

for contour cutting and panel sizing on hard and abrasive materials such as laminates, MDF and melamine. For use on machining centers, point to point boring machines and CNC pantographs equipped with adaptors and chucks.

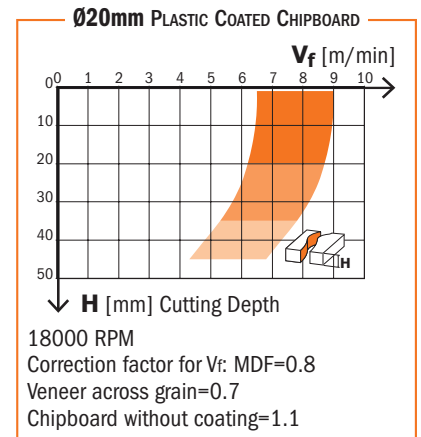

DP - Router Cutters with Shear Angle



142



D mm	I mm	L mm	S mm	Z		ORDER NO. Right-hand rotation
20	27	85	20x50	2+2 (6 DP+1 HW)	1	142.200.61
20	36	95	20x50	2+2 (8 DP+1 HW)	1	142.201.61
20	45	105	20x50	2+2 (10 DP+1 HW)	1	142.202.61
20	55	115	20x50	2+2 (12 DP+1 HW)	1	142.203.61
25	27	90	25x55	2+2 (6 DP+1 HW)	1	142.250.61
25	36	100	25x55	2+2 (8 DP+1 HW)	1	142.251.61
25	45	110	25x55	2+2 (10 DP+1 HW)	1	142.252.61
25	55	120	25x55	2+2 (12 DP+1 HW)	1	142.253.61

TECHNICAL DETAILS:

- Super strength steel.
- DP cutting edge (H2,5").
- HW plunging tip for diagonal plunge-cutting (Z-axis tool entrance).
- Resharpenable cutter (max 3 times).
- Feed speed: max 10m/min

APPLICATION:

for use on CNC routers for jointing, rabbeting, grooving, on laminates, MDF, HPL, veneer and melamine-faced panels.

Ø20-25mm PLASTIC COATED CHIPBOARD

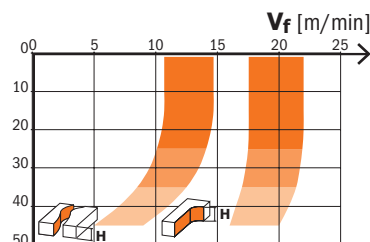

↓ **H [mm] Cutting Depth**

18000 RPM
 Jointing Cutting thickness=0.5-2mm
 Correction factor for Vf: MDF=0.6
 Veneer across grain=0.7

DP - Router Cutters with 20° Shear Angle



142



D mm	I mm	L mm	S mm	Z		ORDER NO. Right-hand rotation
20	25	85	20x45	2+2 (8 DP+1 HW)	1	142.720.61
20	30	90	20x45	2+2 (10 DP+1 HW)	1	142.721.61
20	35	95	20x45	2+2 (12 DP+1 HW)	1	142.722.61
20	40	100	20x45	2+2 (14 DP+1 HW)	1	142.723.61
20	45	105	20x45	2+2 (16 DP+1 HW)	1	142.724.61
20	50	110	20x45	2+2 (18 DP+1 HW)	1	142.725.61
20	55	115	20x45	2+2 (20 DP+1 HW)	1	142.726.61

TECHNICAL DETAILS:

- Super strength steel.
- Diamond cutting edges featuring 20° shear angle (H4).
- HW plunging tip for diagonal plunge-cutting (Z-axis tool entrance).
- Resharpenable cutters (max 8-10 times).
- Max feed speed 20 m/min.

APPLICATION:

for use on CNC routers for jointing, rabbeting, grooving, on laminates, MDF, HPL, veneer and melamine-faced panels.

Ø20-25mm PLASTIC COATED CHIPBOARD

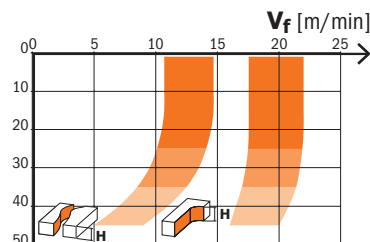

↓ **H [mm] Cutting Depth**

18000 RPM
 Jointing Cutting thickness=0.5-2mm
 Correction factor for Vf: MDF=0.6
 Veneer across grain=0.7



Results shown in this diagram are purely empirical, based merely on informative and hypothetical calculation. Each application may require different parameters in consideration of materials in use and machining conditions. CMT is not responsible for direct, indirect, incidental or consequential damages resulting from any defect, error or failure due to this diagram.

DP - Router Cutters with Shear Angle for Nesting (DENSIMET® Tungsten Heavy Metal Alloys)



143



D mm	I mm	L mm	S mm	Z		ORDER NO. Right-hand rotation
12	25	70	12x40	3 (9 DP)	1	143.120.61
12	31	80	12x40	3 (12 DP)	1	143.121.61

TECHNICAL DETAILS:

- DENSIMET® tungsten heavy metal alloys for low-vibration.
- DP cutting edge (H3).
- Resharpenable cutter (max 6 times).
- Max feed speed 25 m/min.

APPLICATION:

for use on CNC routers for jointing, rabbeting, grooving, on laminates, MDF, HPL, veneer and melamine-faced panels. High performance pre-finishing and finish-routing.

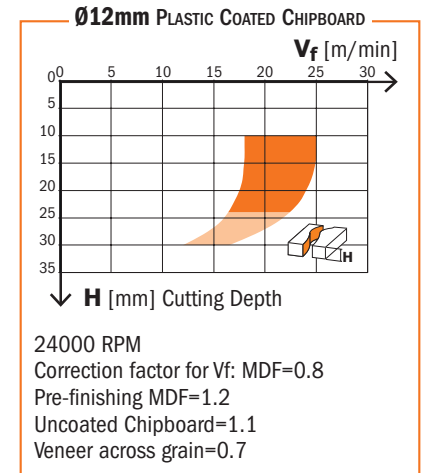

DP - Spiral Router Cutters with Shear Angle



143



D mm	I mm	L mm	S mm	Z		ORDER NO. Right-hand rotation	
18	25	82	20x50	3 (10 DP+1 HW)	1	143.180.61	
18	30	87	20x50	3 (13 DP+1 HW)	1	143.181.61	
18	35	92	20x50	3 (15 DP+1 HW)	1	143.182.61	
20	25	82	20x50	3 (10 DP+1 HW)	1	143.200.61	
20	30	85	20x50	3 (13 DP+1 HW)	1	143.201.61	
20	35	92,5	20x50	3 (15 DP+1 HW)	1	143.202.61	
20	40	97	20x50	3 (18 DP+1 HW)	1	143.203.61	
20	45	102	20x50	3 (21 DP+1 HW)	1	143.204.61	
20	50	106,5	20x50	3 (24 DP+1 HW)	1	143.205.61	
20	55	111	20x50	3 (27 DP+1 HW)	1	143.206.61	
20	60	116,5	20x50	3 (30 DP+1 HW)	1	143.207.61	
20	65	121,5	20x50	3 (31 DP+1 HW)	1	143.208.61	
22	30	92	25x50	3 (13 DP+1 HW)	1	143.220.61	
	22	35	97	25x50	3 (15 DP+1 HW)	1	143.221.61
	22	40	102	25x50	3 (18 DP+1 HW)	1	143.222.61
	22	45	107	25x50	3 (21 DP+1 HW)	1	143.223.61
	22	50	112	25x50	3 (24 DP+1 HW)	1	143.224.61
	22	55	117	25x50	3 (27 DP+1 HW)	1	143.225.61
	22	60	122	25x50	3 (30 DP+1 HW)	1	143.226.61
	22	65	127	25x50	3 (31 DP+1 HW)	1	143.227.61
	22	70	132	25x50	3 (36 DP+1 HW)	1	143.228.61

On request

TECHNICAL DETAILS:

- Super strength steel.
- DP cutting edge (H4).
- HW plunging tip for diagonal plunge-cutting (Z-axis tool entrance).
- Resharpenable cutter (max 8-10 times).

APPLICATION:

for use on CNC routers for jointing, rabbeting, grooving, on laminates, MDF, HPL, veneer and melamine-faced panels. High performance pre-finishing and finish-routing.

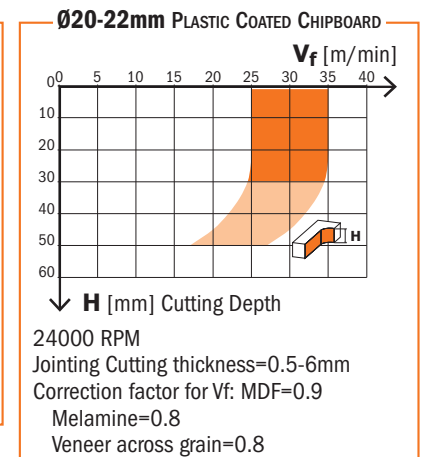
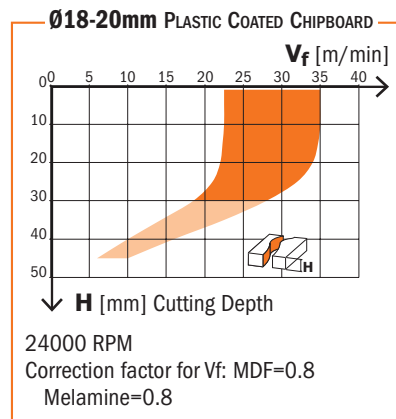

Results shown in this diagram are purely empirical, based merely on informative and hypothetical calculation. Each application may require different parameters in consideration of materials in use and machining conditions. CMT is not responsible for direct, indirect, incidental or consequential damages resulting from any defect, error or failure due to this diagram.

DP - Router Cutters with 40° Shear Angle



145

D mm	I mm	L mm	S mm	Z		ORDER NO. Right-hand rotation
<input type="checkbox"/> 50	23	80	25x55	3+3 (9 DP)	1	145.501.61
<input type="checkbox"/> 50	23	80	25x55	4+4 (12 DP)	1	145.511.61
<input type="checkbox"/> 50	28	85	25x55	3+3 (12 DP)	1	145.502.61
<input type="checkbox"/> 50	28	85	25x55	4+4 (16 DP)	1	145.512.61
<input type="checkbox"/> 50	38	95	25x55	3+3 (18 DP)	1	145.503.61
<input type="checkbox"/> 50	38	95	25x55	4+4 (24 DP)	1	145.513.61

On request

TECHNICAL DETAILS:

- Super strength steel.
- "H4" diamond cutting edges featuring 40° shear angle.
- Resharpenable cutters (max 10 times).
- Maximum feed speed 30m/minute.

APPLICATION:

used on all CNC routers for jointing, rabbeting, grooving, copying and dividing raw material, melamine, laminated, MDF, HPL and veneered panels. High performance routing.

Straight Bits for Industrial Nesting Application **DLCS Chrome Coating**

new



8/912



D mm	I mm	L mm		ORDER NO. S=Ø10mm	ORDER NO. S=Ø12mm	ORDER NO. S=Ø12,7mm
6	21	73	10		912.561.11	
6	26	73	10		912.560.11	
6,35	26	73	10			812.564.11
8	21	73	10		912.582.11	
8	28,7	76	10		912.581.11	
8	28,7	76	10			812.581.11
8	32	76	10		912.583.11	
10	21	75	10	912.610.11		
10	32	75	10	912.611.11		

TECHNICAL DETAILS:

- Premium quality HWM.
- Special positively ground cutting edge sharpening for excellent finish.



DLCS CHROME COATING:

- Superb wear resistance
- Better chip clearance
- Superior cutting quality
- Less overheating
- More productivity

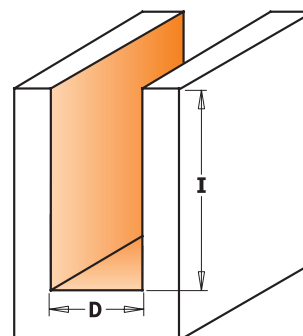

Drawing is 1:1 scale

3X
LONGER LIFE
THAN UNCOATED

DLCS CHROME COATING

provides 3 times longer life than uncoated tools!



174



D mm	I mm	L mm	S mm		ORDER NO. Right-hand rotation
3	10	55	8	10	174.030.11
4	10	55	8	10	174.040.11
5	12	55	8	10	174.050.11
6	14	55	8	10	174.060.11
7	20	55	8	10	174.070.11

TECHNICAL DETAILS:

- Premium quality HWM.
- 2 radial relief cutting edges [Z2].
- 1 HW [Z1] plunge cutting edge.

Router Cutters

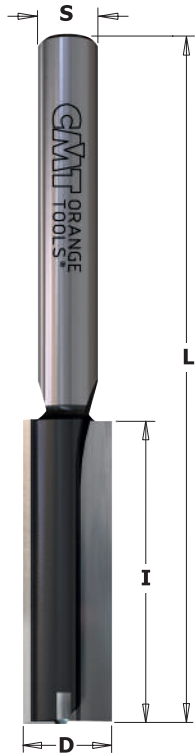

174



D mm	I mm	L mm	S mm		ORDER NO. Right-hand rotation
8	20	55	8	10	174.080.11
8	30	70	8	10	174.081.11
8	40	90	8	10	174.082.11
9	20	55	8	10	174.090.11
10	20	60	8	10	174.100.11
10	30	70	8	10	174.102.11
10	40	90	8	10	174.101.11
11	20	60	8	10	174.110.11
12	20	60	8	10	174.120.11
12	30	70	8	10	174.122.11
12	40	90	8	10	174.121.11
13	20	60	8	10	174.130.11
14	20	60	8	10	174.140.11
14	30	70	8	10	174.142.11
14	40	90	8	10	174.141.11
15	20	60	8	10	174.150.11
16	20	70	8	10	174.160.11
16	30	70	8	10	174.162.11
16	40	90	8	10	174.161.11
18	20	70	8	10	174.180.11
18	30	70	8	10	174.181.11
18	40	80	8	10	174.182.11
19	20	70	8	10	174.190.11
20	20	70	8	10	174.200.11
20	30	70	8	10	174.201.11
20	40	90	8	10	174.202.11
22	20	70	8	10	174.220.11
22	30	70	8	10	174.221.11
22	40	90	8	10	174.222.11
23,5	20	70	8	10	174.235.11
24	20	70	8	10	174.240.11
24	30	70	8	10	174.241.11
24	40	90	8	10	174.242.11
25	20	70	8	10	174.250.11
26	20	70	8	10	174.260.11
26	30	70	8	10	174.261.11
28	20	70	8	10	174.280.11
28	30	70	8	10	174.281.11
29	20	70	8	10	174.290.11
30	20	70	8	10	174.300.11
32	20	70	8	10	174.320.11

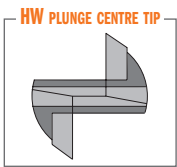

TECHNICAL DETAILS:

- Super strength steel.
- 2 precision ground HW cutting edges and 1 HW plunge centre tip [Z2+1].

APPLICATION:

used for drilling, grooving or jointing on solid wood and wood composites. Can be used on machining centres, CNC routers and hand-held routers equipped with chucks or adapters.

new

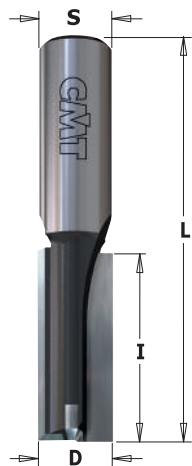

112



D mm	I mm	L mm	S mm		ORDER NO. Right-hand rotation
• 3	10	48	9,5	50	112.030.11
• 4	10	48	9,5	50	112.040.11
• 5	12	48	9,5	50	112.050.11
• 6	14	41	9,5	50	112.060.11
• 7	16	43	9,5	50	112.070.11
• 8	18	48	9,5	50	112.080.11
• 8	30	60	9,5	50	112.081.11
• 9	20	55	9,5	50	112.090.11
10	22	52	9,5	50	112.100.11
10	35	65	9,5	50	112.101.11
11	26	52	9,5	10	112.110.11
12	26	52	9,5	10	112.120.11

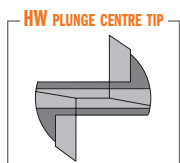

• HWM

TECHNICAL DETAILS:

- Super strength steel.
- 2 precision ground HW cutting edges
- 1 HW plunge centre tip [Z2+1].

Router Cutters



113



D mm	I mm	L mm	S mm		ORDER NO. Right-hand rotation
12	26	52	12	10	113.120.11
12	40	70	12	10	113.121.11
13	26	52	12	10	113.130.11
14	28	56	12	10	113.140.11
14	40	72	12	10	113.141.11
15	32	60	12	10	113.150.11
16	32	60	12	10	113.160.11
16	40	72	12	10	113.161.11
18	35	64	12	10	113.180.11
19	38	68	12	1	113.190.11
20	38	68	12	1	113.200.11
22	40	72	12	1	113.220.11
24	40	72	12	1	113.240.11
25	40	72	12	1	113.250.11
26	42	74	12	1	113.260.11
28	42	74	12	1	113.280.11
30	42	74	12	1	113.300.11

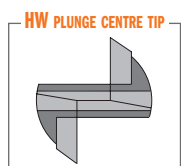

TECHNICAL DETAILS:

- Super strength steel.
- 2 precision ground HW cutting edges
- 1 HW plunge centre tip [Z2+1].

APPLICATION:

used for plunging cutting and grooving on solid wood and wood derivatives as well as laminates and plastic materials. For use on CNC machining centres, CNC routers, hand-held routers and point-to-point machines equipped with chucks or adapters.

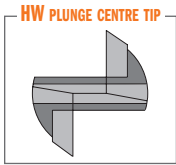
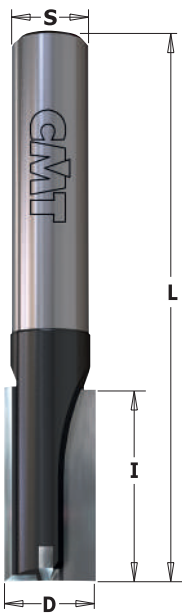

TECHNICAL DETAILS:

- Premium quality HWM.
- 2 radial relief cutting edges [Z2].
- 1 HW [Z1] plunge centre tip.

APPLICATION:

used for plunging cutting and grooving on solid wood and wood derivatives as well as laminates and plastic materials. For use on CNC machining centres, CNC routers, hand-held routers and point-to-point machines equipped with chucks or adapters.

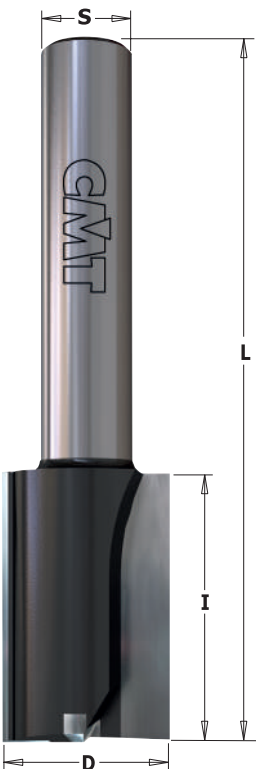

175



D mm	I mm	L mm	S mm		ORDER NO. Right-hand rotation
• 4	10	65	10	50	175.040.11
• 5	12	65	10	50	175.050.11
• 6	14	65	10	50	175.060.11
• 7	16	65	10	50	175.070.11
8	20	65	10	50	175.080.11
10	25	70	10	50	175.100.11
12	25	70	10	10	175.120.11
14	25	70	10	10	175.140.11
15	25	70	10	10	175.150.11
16	25	70	10	10	175.160.11
18	25	70	10	10	175.180.11
20	25	70	10	10	175.200.11
22	25	70	10	10	175.220.11
24	25	70	10	10	175.240.11
25	25	70	10	10	175.250.11
26	25	70	10	10	175.260.11
30	25	70	10	10	175.300.11
35	25	70	10	10	175.350.11

• HWM

176



D mm	I mm	L mm	S mm		ORDER NO. Right-hand rotation
10	40	87	10	10	176.100.11
12	40	87	10	10	176.120.11
14	40	87	10	10	176.140.11
15	40	87	10	10	176.150.11
16	40	87	10	10	176.160.11
18	40	87	10	10	176.180.11
20	40	87	10	10	176.200.11

177



D mm	I mm	L mm	S mm		ORDER NO. Right-hand rotation
10	35	90	12	10	177.100.11
12	35	90	12	10	177.120.11
12	50	100	12	10	177.121.11
14	35	90	12	10	177.140.11
16	35	90	12	10	177.160.11
16	60	110	12	10	177.161.11
18	35	90	12	10	177.180.11
18	60	110	12	10	177.181.11
20	35	90	12	10	177.200.11
22	35	90	12	10	177.220.11
24	35	90	12	10	177.240.11
25	35	90	12	10	177.250.11
26	35	90	12	10	177.260.11
28	35	90	12	10	177.280.11
30	35	90	12	10	177.300.11
35	35	90	12	10	177.350.11

TECHNICAL DETAILS:

- Super strength steel.
- 2 precision ground HW cutting edges
- 1 HW plunge centre tip [Z2+1].

APPLICATION:

used for plunge cutting and grooving on solid wood, wood derivatives as well as laminates and plastic materials. For use on CNC machining centres, CNC routers and hand-held routers.

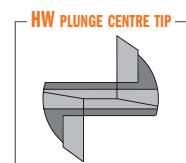

XTreme Plunge CNC Cutters with Insert Knives



653 XTREME



D mm	I mm	L mm	S mm	Box	ORDER NO. Right-hand rotation	Spare parts	
40	29,5	100	20	10	653.001.11		
						790.295.12	790.120.00

Spare parts: 990.075.00 M4x6mm TORX® screw
 991.061.00 T15 TORX® key
 990.036.00 M8x25mm TE screw
 990.020.00 Hex nut for threaded arbors M8

TECHNICAL DETAILS:
 - Super strength steel.
 - 4 cutting edges [Z2+2]

APPLICATION:
 the new CNC cutter is designed with 2 plunging knives and two-sided knives fixed by special TORX® screws. It is ideal for direct plunge into the material and fast removal over a large surface area leaving an improved finish at the bottom of the cut. For cutting soft/hard wood, chipboard, melamine, MDF. For use on pantograph CNC machines.

SAFETY TIPS:
 The **TW-006** Torque Screwdriver is recommended for the proper fastening of screws (see page 406).

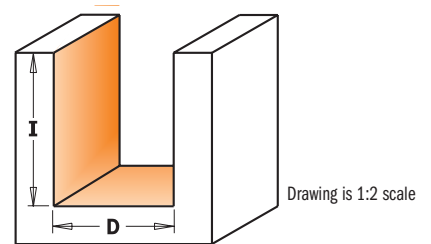
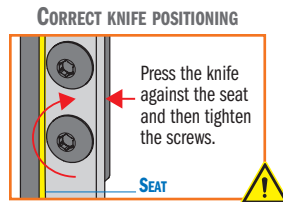

Straight Router Cutters with Insert Knives



653



D mm	I mm	L mm	S mm	Box	ORDER NO. Right-hand rotation	Spare parts	
16	28,3	92	20	10	653.661.11		
16	48,3	111,5	20	10	653.662.11	790.283.12	790.075.00
18	48,3	111,5	20	10	653.681.11	790.483.12	790.075.00
20	48,3	111,5	20	10	653.701.11	790.483.12	790.075.00

Spare parts: 990.072.00 M3,5x3,5mm TORX® screw
 990.074.00 M4x3,5mm TORX® screw
 990.075.00 M4x6mm TORX® screw
 991.061.00 T15 TORX® key

TECHNICAL DETAILS:
 - Super strength steel.
 - 2 cutting edges [Z1+1].

APPLICATION:
 straight router bits with on replaceable plunging knife and side knife fixed by a special TORX® screw. The tool bodies are precisely balanced. For finishing, routing, plunging and grooving on board materials (laminated chipboards and MDF) and hardwood. For use on portable routers or CNC machining centres.

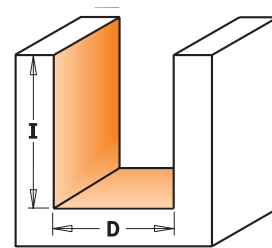
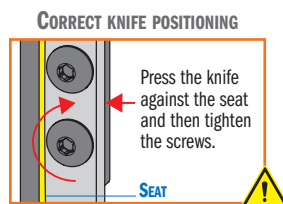

SAFETY TIPS:
 The **TW-006** Torque Screwdriver is recommended for the proper fastening of screws (see page 406).

Spoilboard Surfacing Router Cutters with Insert Knives

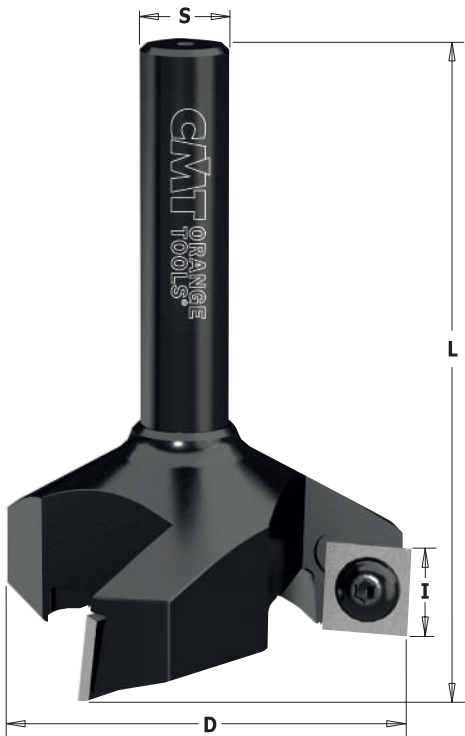

663



D mm	I mm	L mm	Z	S mm	Box	ORDER NO. Right-hand rotation
35	10,5	60	3	8x38	10	663.007.11
38	12	60	3	12x38	10	663.005.11
new 38	12	60	3	12,7x38	10	663.015.11
new 60	12	80	3	12x50	10	663.004.11
60	12	80	3	12,7x50	10	663.014.11
80	12	90	3	20x60	10	663.003.11
100	12	90	4	20x50	1	663.006.11

Spare parts

790.105.03*	990.078.00
790.120.03*	990.075.00
790.120.03*	990.075.00
790.120.03*	990.075.00
790.120.03*	990.075.00
790.120.03*	990.075.00
790.120.03*	990.075.00

Spare parts: **991.061.00** T15 TORX® key
990.036.00 M8x25mm TE screw (for 663.003.11 and 663.006.11)
990.020.00 Hex nut for threaded arbors M8 (for 663.003.11 and 663.006.11)

*Minimum 10 pieces or multiple

TECHNICAL DETAILS:
 - Super strength steel.
 - 3 cutting edges [Z3].
 - 4 cutting edges [Z4].

APPLICATION:
 the new router bit for CNC routers is ideal for fast removal of material over a large surface area leaving an improved finish at the bottom of the cut. Used on soft and hardwood, particle board and MDF. The cutter uses 4-sided inserts in super micrograin carbide.

A cost effective solution compared to brazed router bits and solid carbide spiral bits.

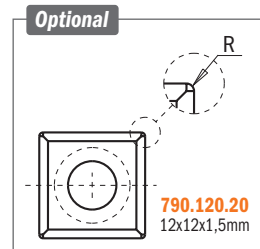

SAFETY TIPS:



The **TW-006** Torque Screwdriver is recommended for the proper fastening of screws (see page 406).

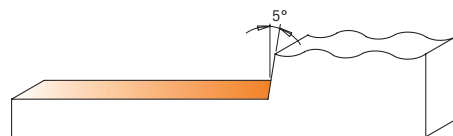
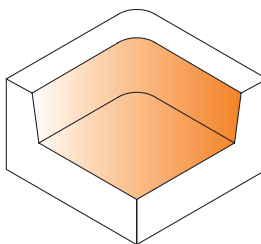

Drawing is 1:2 scale

Spoilboard Surfacing Router Cutters

new



178



D mm	I mm	L mm	Z	S mm	Box	ORDER NO. Right-hand rotation
25,4	6,35	41	3	6,35	1	178.701.11
34,9	9,5	57	3	8	1	178.702.11
50,8	12,7	63,5	4	12	1	178.703.11
50,8	12,7	63,5	4	12,7	1	178.704.11

TECHNICAL DETAILS:
 - Super-strength steel.
 - 3 cutting edge [Z3]
 - 4 cutting edge [Z4]

APPLICATION:
 The new router bit for CNC routers is ideal for fast removal of material over a large surface area leaving an improved finish at the bottom of the cut. Used on soft and hardwood, particle board and MDF. The cutter uses 4-sided inserts in super micrograin carbide. A cost effective solution compared to brazed router bits and solid carbide spiral bits.

XTreme Spoilboard Surfacing Router Cutter with Insert Knives

new

CMT ORANGE TOOLS®

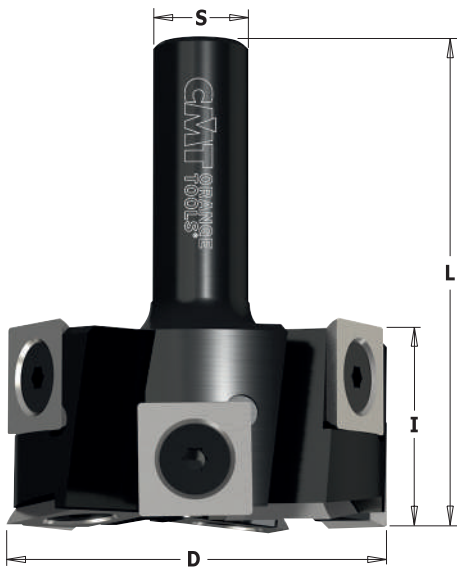

663.5 XTREME



D mm	I mm	L mm	S mm	Box	ORDER NO. Right-hand rotation	Spare parts	
50,8	25,4	63,5	12	10	663.502.11		
50,8	25,4	63,5	12,7	10	663.501.11	790.140.20*	990.080.00
						790.140.20*	990.080.00

TECHNICAL DETAILS:
 - Super strength steel
 - 6 + 3 cutting edges [Z6+V3]

APPLICATION: this new router bit designed for CNC router machines and stationary router machine work centers are ideal for rabbeting joints and for quick chip removal on large surface areas and leaves a good finish at the bottom of the cut. Ideal for soft and hard wood, particle board and MDF. This bit is equipped with 4 sided insert knives in super micrograin carbide - an economical solution for brazed and solid carbide spiral bits.



*Minimum 10 pieces or multiple

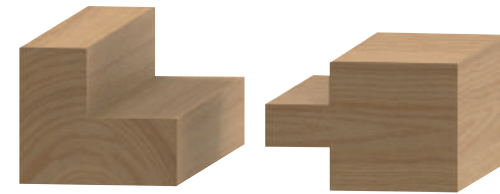
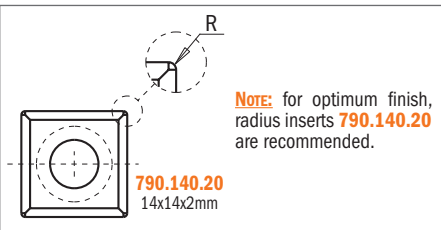

SAFETY TIPS:
 The **TW-006** Torque Screwdriver is recommended for the proper fastening of screws (see page 406).

Universal Profile Cutter for CNC Machines



KNIVES NOT INCLUDED

663.301



D mm	I mm	L mm	S mm	Box	ORDER NO. Right-hand rotation
65	40-50	93	20	1	663.301.11

Spare parts: **692.999.01** 38x15x16mm wedge for cutter
990.064.00 M8x16mm STEI screw
991.064.00 Hex key 4mm

TECHNICAL DETAILS:
 - Super Strength steel.
 - 2 cutting edges [Z2] for knives 40x4mm and 50x4mm.

APPLICATION: for universal profiling of solid wood on CNC router machines. For cutting width 40mm and 50mm (serie **690**). Profile knives may only be ordered and used in pairs.

USEFUL TIPS: for enhanced safety, when using 50mm knives, it is recommended to carry out the cut in several passes.

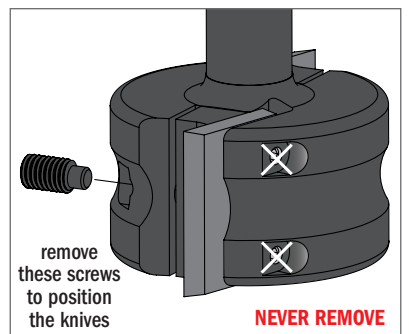

SAFETY TIPS:
 The **TW-006** Torque Screwdriver is recommended for the proper fastening of screws (see page 406).

Suggested MAX RPM 12.000

TO BE USED WITH SP KNIVES SERIES 690 (SEE PAGE 118~131)

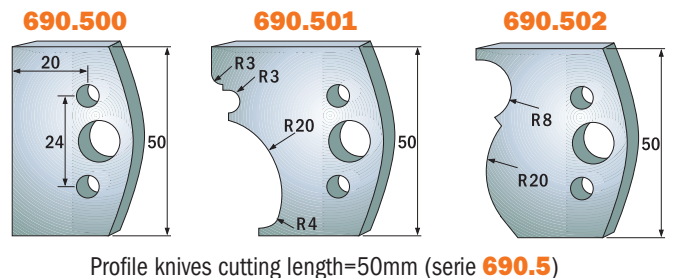
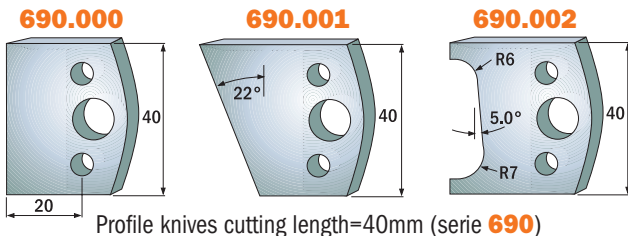

Adjustable Chamfering CNC Cutter

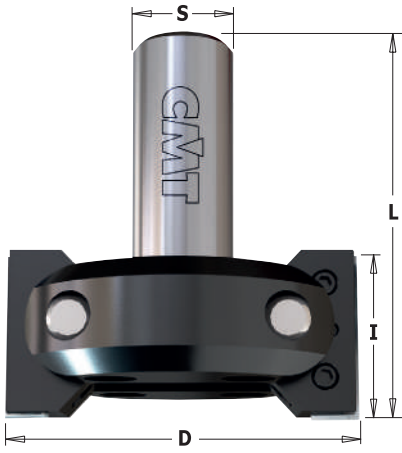

663.201



D mm	D_Max 45° mm	I mm	A	L mm	S mm	Box	ORDER NO.
85	102	39,5	0°-45° - 0°+90°	92	20	1	Right-hand rotation 663.201.11

- Spare parts:**
- 790.395.12** 39,5x12x1,5mm knife (Minimum 10 pieces or multiple)
 - 663.999.01** 38x6x12mm wedge
 - 990.087.00** M6x8mm STEI screw (4x2mm threaded pin)
 - 991.067.00** 3mm hex key
 - 663.999.02** Kit with 2 wedges and 1 screw for blocking rotation
 - 990.099.00** M8x25mm TCEI screw
 - 990.023.00** M8 (4mm) nut
 - 991.081.00** 4mm "T" hex key

SAFETY TIPS:

The **TW-006** Torque Screwdriver is recommended for the proper fastening of screws (see page 406).

TECHNICAL DETAILS:

- Tool body in steel
- 2 reversible HWM knives 39,5x12x1,5mm [Z2]
- Peripheral cutting on both sides
- Adjustable swivelling blade (Rotates at 7,5° intervals; Precision = 7,5°)
- Swivelling range 0-45° towards top, and 0-90° towards bottom

APPLICATION:

for jointing, rebating and chamfering of solid wood and wooden boards. Suitable for CNC router machines and stationary router machine with manual or mechanical feed. Never modify the chamfering angle whilst changing the knives. RH rotation.

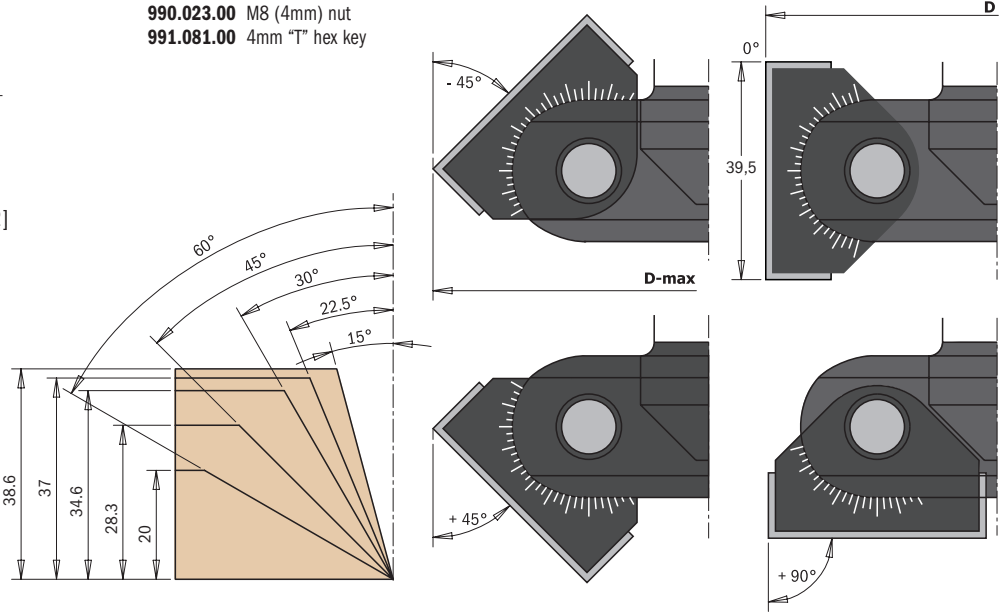

V-Groove - Folding - Signmaking CNC Router Cutters with Insert Knives



663.1



D mm	I mm	L mm	A	S mm	Z	Box	ORDER NO.
34	40	115	45°	20	1	10	Right-hand rotation 663.103.11
44	38	115	60°	20	1	5	663.102.11
52	25	102	91°	20	1	1	663.101.11
60	21	95	110°	20	1	1	663.110.11
87,5	24	95	120°	20	2	1	663.120.11
91	20	95	130°	20	2	1	663.130.11
96,5	12,4	95	150°	20	2	1	663.150.11

Spare parts

790.580.01*	
790.580.01*	
790.360.01*	
790.360.01*	
790.496.01*	
790.496.01*	
790.496.01*	

- Spare parts:**
- 990.073.00** M3,5x5x7,2mm TORX® T15 screw (for 790.580.01 and 790.360.01)
 - 990.075.00** M4x6x8,2mm TORX® T15 screw (for 790.496.01)
 - 991.061.00** T15 TORX® key
 - 990.036.00** M8x25mm TE screw
 - 990.020.00** Hex nut for threaded arbors M8

Optional 5790.360.03* 36x12x1,5mm HW-SMG replaceable knife (4 cutting edges 35°)

*Minimum 10 pieces or multiple

SAFETY TIPS:

The **TW-006** Torque Screwdriver is recommended for the proper fastening of screws (see page 406).

CORRECT KNIFE POSITIONING

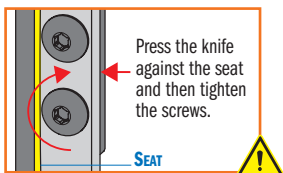

TECHNICAL DETAILS:

- Super strength steel.
- 1 cutting edge [Z1]
- 2 cutting edges [Z2]

APPLICATION:

this innovative CNC router bit offers you an endless range of possibilities for V-Groove, miter folds, signmaking, lettering and chamfer edges. The tool mounts a high grade HWM reversible knife ideal for general purpose, chipboard and plywood, but knives with increased hardness are available for laminated and MDF material.

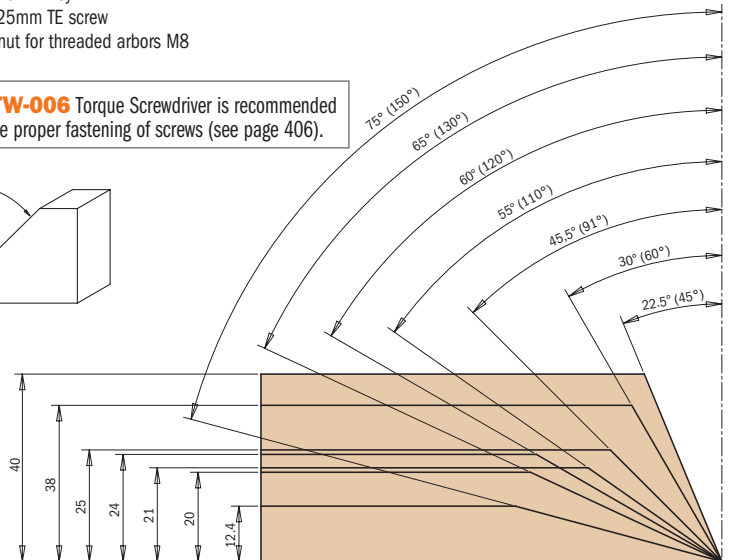
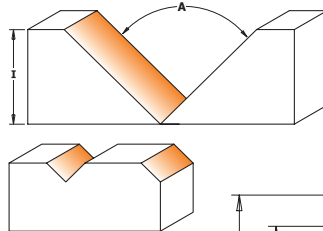



300.023.01 Basic CNC Kit

DESCRIPTION	Q.TY	ORDER NO.
CHUCK -XTREME- HSK-63F (H73) "ER32" PRECISION COLLET RH	1	183.300.01
C-SPANNER FOR "ER32" PRECISION COLLET	1	991.183.00
PRECISION COLLET DIN6499 "ER32" (33x40mm) D=12mm	1	184.120.00
PRECISION COLLET DIN6499 "ER32" (33x40mm) D=20mm	1	184.200.00
STRAIGHT ROUTER CUTTER WITH INSERT KNIVES HW Z1+1 S=20 D=18x48.3mm RH	1	653.681.11
HWM REVERSIBLE KNIVES STD (4/35°) 48.3x12x1.5mm RH	10	790.483.12
HWM REVERSIBLE KNIVES STD (2/35°) 7.5x12x1.5mm	10	790.075.00
KEY TORX® T15	1	991.061.00
SOLID CARBIDE UPCUT SPIRAL BITS Z3 POS. HWM D=12x42x90mm RH	1	193.121.11
2 FLUTE DOWEL DRILL HW S=10x30mm D=5x35x70mm RH	2	311.050.11
2 FLUTE DOWEL DRILL HW S=10x30mm D=5x35x70mm LH	2	311.050.12
2 FLUTE DOWEL DRILL HW S=10x30mm D=8x35x70mm RH	4	311.080.11
2 FLUTE DOWEL DRILL HW S=10x30mm D=8x35x70mm LH	4	311.080.12
HINGE BORING BITS HW Z2+2 S=10x26mm D=15x70mm RH	1	369.150.11
HINGE BORING BITS HW Z2+2 S=10x26mm D=35x70mm RH	1	369.350.11

At request available with ER40



300.025.01 Expert for "Nesting" CNC Kit

DESCRIPTION	Q.TY	ORDER NO.
CHUCK -XTREME- HSK-63F (H73) "ER32" PRECISION COLLET RH	2	183.300.01
C-SPANNER FOR "ER32" PRECISION COLLET	1	991.183.00
PRECISION COLLET DIN6499 "ER32" (33x40mm) D=12mm	1	184.120.00
PRECISION COLLET DIN6499 "ER32" (33x40mm) D=20mm	1	184.200.00
KINETIC DUST EXTRACTOR FOR CHUCK WITH "ER32" D=100mm RH	1	992.101.ER32
C-SPANNER 95-100mm FOR KINETIC "ER32"/"ER40"	1	991.284.00
SPOILBOARD SURFACING ROUTER CUTTER W/INSERT KNIVES HW Z3 S=20x50mm D=80x12x90mm	1	663.003.11
HWM REVERSIBLE KNIVES STD (4/35°) 12x12x1.5mm	10	790.120.03
KEY TORX® T15	1	991.061.00
ROUTER CUTTERS WITH SHEAR ANGLE FOR NESTING Z3 9DP S=12mm D=12x25x70mm RH	1	143.120.61
2 FLUTE DOWEL DRILL HW S=10x30mm D=5x35x70mm RH	2	311.050.11
2 FLUTE DOWEL DRILL HW S=10x30mm D=5x35x70mm LH	2	311.050.12
2 FLUTE DOWEL DRILL HW S=10x30mm D=8x35x70mm RH	4	311.080.11
2 FLUTE DOWEL DRILL HW S=10x30mm D=8x35x70mm LH	4	311.080.12
HINGE BORING BITS HW Z2+2 S=10x26mm D=15x70mm RH	1	369.150.11
HINGE BORING BITS HW Z2+2 S=10x26mm D=35x70mm RH	1	369.350.11



Includes:

KINETIC
DUST EXTRACTOR

At request available with ER40



616.000.01

This unique system includes a tool body with 22 profile knives designed for multiple applications on your CNC routers. Ideal for MDF, laminates, veneers, plastic, wood and solid surface materials.

TECHNICAL DETAILS:

Knives 20x20x2mm.

We recommend re-sharpening the knives on profile cutting edge.

SAFETY TIPS:



The **TW-006** Torque Screwdriver is recommended for the proper fastening of screws (see page 406).

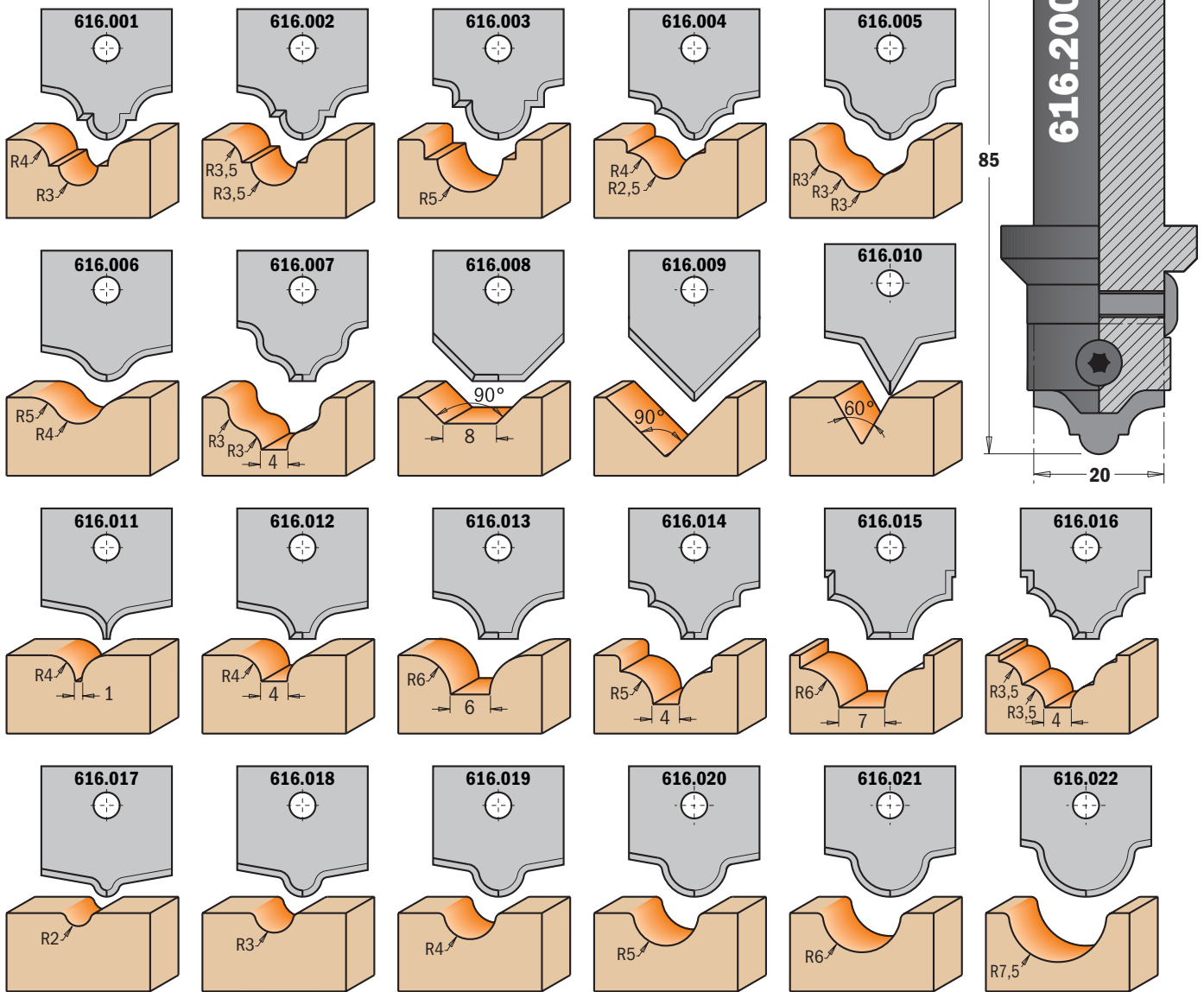

Drawing is 1:1 scale

DESCRIPTION	S mm		ORDER NO. Right-hand rotation	Spare parts		
Complete Set for Decorating on MDF	20	10	616.000.01			
Router cutter body with shank Ø20mm (insert knives not included)	20	10	616.200	616.200	990.077.00	991.061.00
Router cutter body with shank Ø12mm (insert knives not included)	12	10	616.120		990.077.00	991.061.00

REMARK: tool body and insert knives can be sold individually.

Complete Set for MDF Doors



615.004.01

Open some new doors with CMT. Our 4-piece set includes the most popular profile to make MDF panel doors for kitchens and bathrooms. Each bit is made from bar stock steel and is equipped with 5 different profile knives allowing enormous possibilities for easy and economical construction. The highest materials, the lowest tolerance in balancing and the precision in the sharpening of the knives let you obtain a smooth finish on your CNC machine.

SAFETY TIPS:



The **TW-006** Torque Screwdriver is recommended for the proper fastening of screws (see page 406).



DESCRIPTION	S mm		ORDER NO. Right-hand rotation	Spare parts	
Complete Set for MDF Doors (Profile no. 1)	20	1	615.004.01	990.077.00	991.061.00

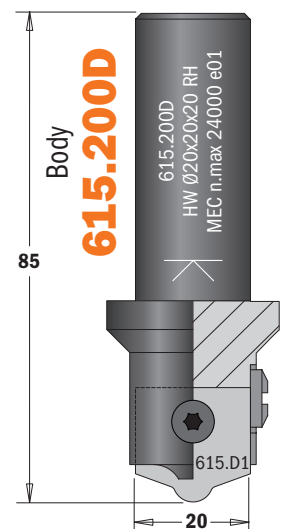
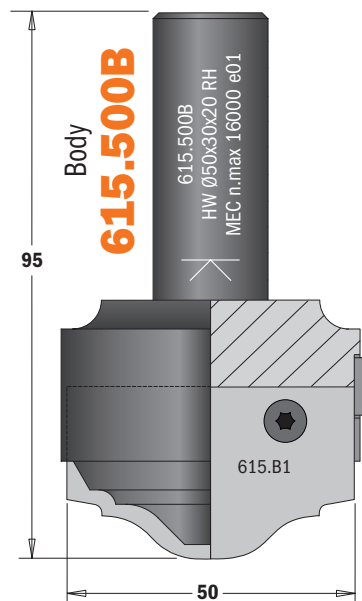
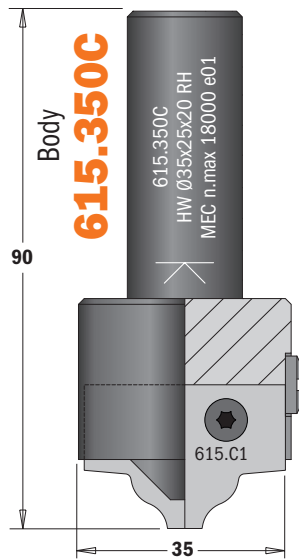
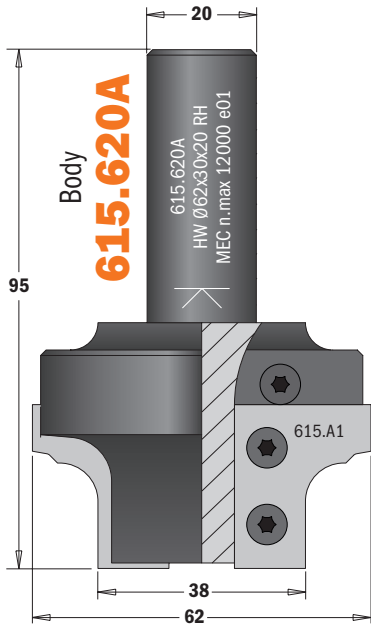

Standard

Profile No. 1

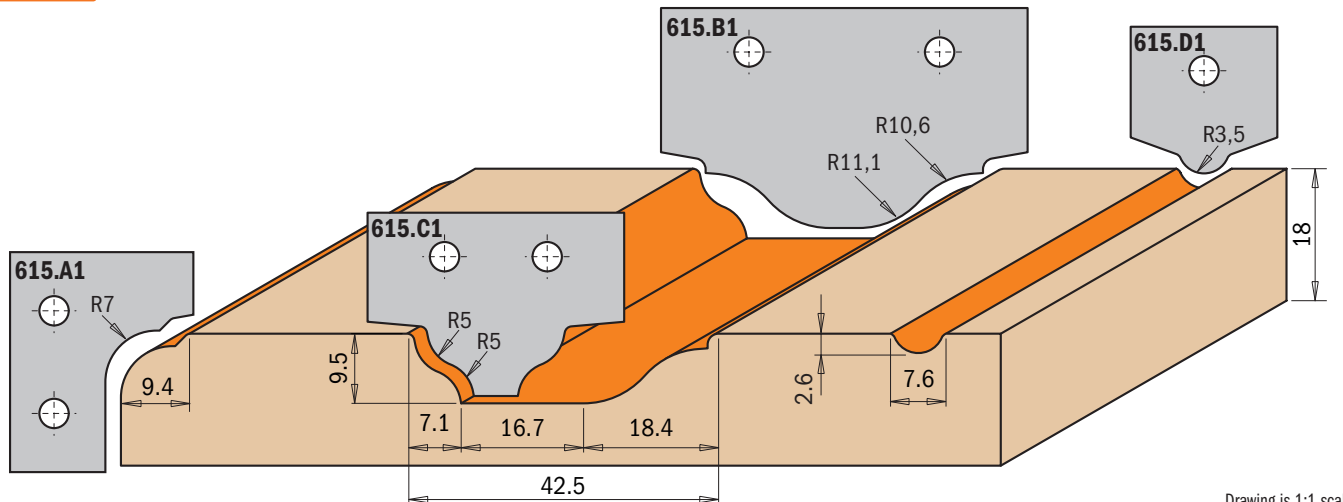

Drawing is 1:1 scale

Optional

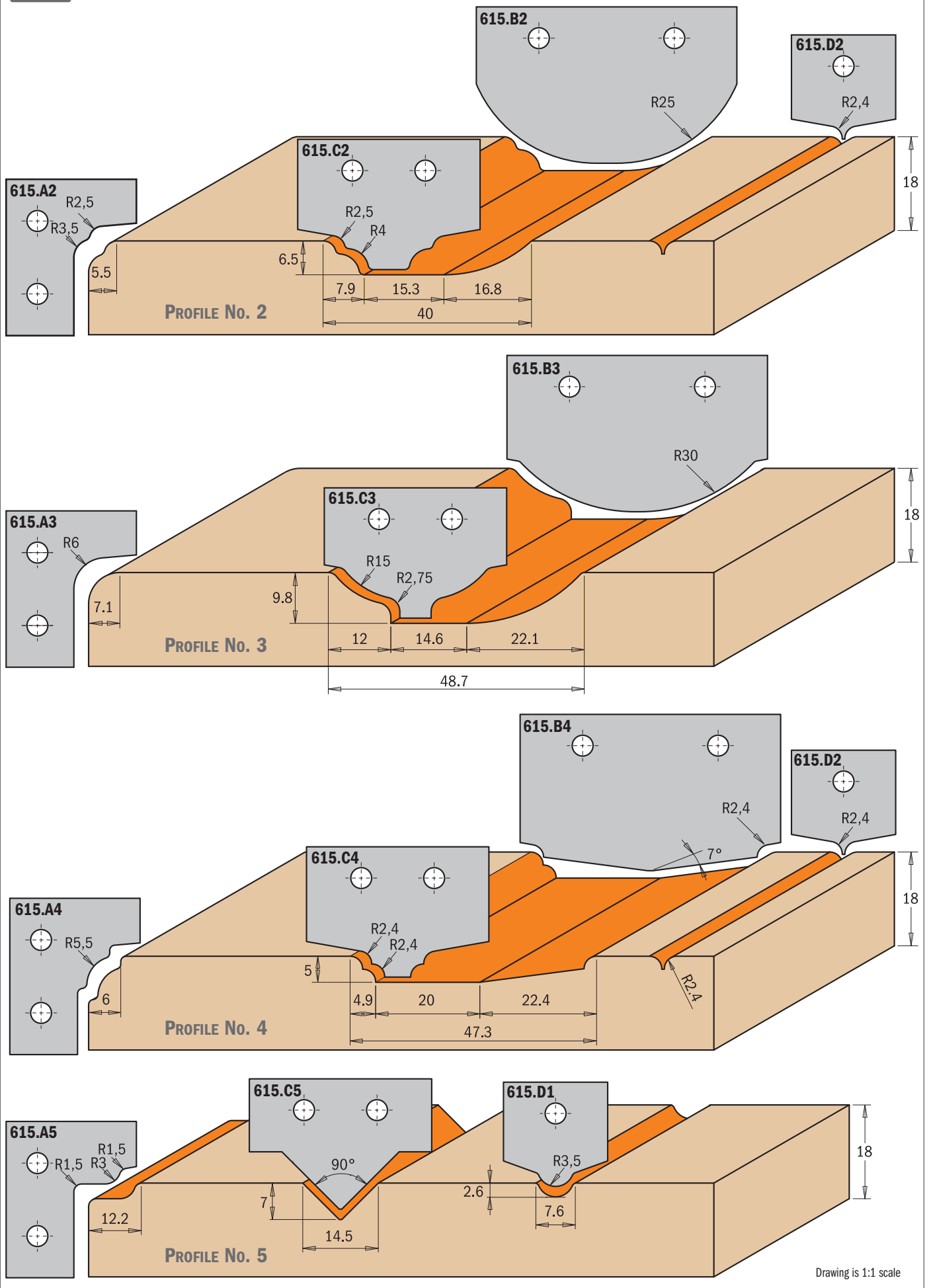

Drawing is 1:1 scale



102



D mm	I mm	L mm	S mm		ORDER NO. Right-hand rotation	ORDER NO. Left-hand rotation
6	50	105	16	10	102.060.31	102.060.32
7	55	110	16	10	102.070.31	102.070.32
8	60	115	16	10	102.080.31	102.080.32
9	65	120	16	10	102.090.31	102.090.32
10	70	125	16	10	102.100.31	102.100.32
11	75	130	16	10	102.110.31	102.110.32
12	80	135	16	10	102.120.31	102.120.32
13	85	140	16	10	102.130.31	102.130.32
14	90	145	16	10	102.140.31	102.140.32
15	95	150	16	10	102.150.31	102.150.32
16	100	155	16	10	102.160.31	102.160.32
17	105	160	16	10	102.170.31	102.170.32
18	110	165	16	10	102.180.31	102.180.32
19	115	170	16	10	102.190.31	102.190.32
20	120	175	16	10	102.200.31	102.200.32
22	125	180	16	10	102.220.31	102.220.32
24	125	180	16	10	102.240.31	102.240.32

172

D mm	I mm	L mm	S mm		ORDER NO. Right-hand rotation	ORDER NO. Left-hand rotation
6	50	105	13	10	172.060.31	172.060.32
7	55	110	13	10	172.070.31	172.070.32
8	60	115	13	10	172.080.31	172.080.32
9	65	120	13	10	172.090.31	172.090.32
10	70	125	13	10	172.100.31	172.100.32
11	75	130	13	10	172.110.31	172.110.32
12	80	135	13	10	172.120.31	172.120.32
13	85	140	13	10	172.130.31	172.130.32
14	90	145	13	10	172.140.31	172.140.32
15	95	150	13	10	172.150.31	172.150.32
16	100	155	13	10	172.160.31	172.160.32
18	110	165	13	10	172.180.31	172.180.32
20	120	175	13	10	172.200.31	172.200.32

TECHNICAL DETAILS:

- Long-lasting cutting performance.
- 2 HL precision ground straight cutting edges with chip-breaker teeth [Z2R].

APPLICATION:

for cutting deep mortise slots in natural soft and medium density wood. For use on combination machining centres equipped with adaptors and/or chucks.

GUIDE TO MACHINING DEEP SLOTS

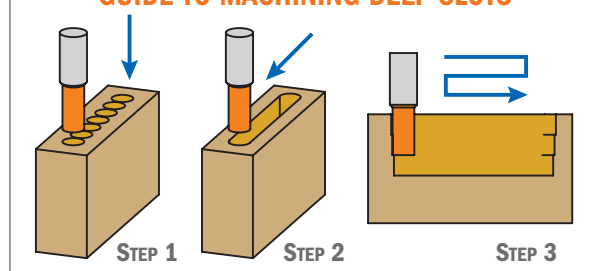

6-Piece Mortising Bit Sets

102 - 172



Our classic set of 6 spiral mortising bits with both Ø16mm and Ø13mm shanks made of super strength high speed steel and available in left-hand or right-hand rotation. Safely packaged in a plastic box for protection, these sets are economical and a perfect addition to any workshop.



S mm	D mm		ORDER NO. Right-hand rotation	ORDER NO. Left-hand rotation
16	6-8-10-12-14-16	1	102.001.00	102.001.10
13	6-8-10-12-14-16	1	172.001.00	172.001.10

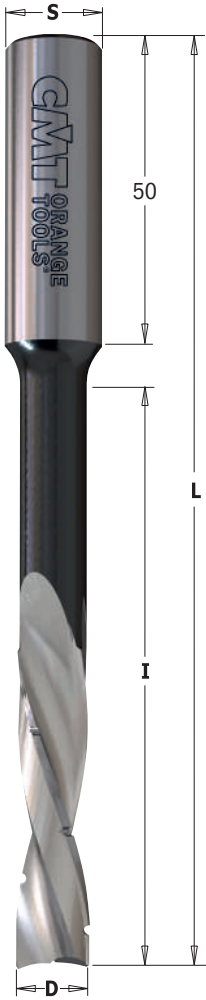

161



D mm	I mm	L mm	S mm		ORDER NO. Right-hand rotation	ORDER NO. Left-hand rotation
6	60	120	16	10	161.060.31	161.060.32
8	70	130	16	10	161.080.31	161.080.32
10	80	140	16	10	161.100.31	161.100.32
12	90	150	16	10	161.120.31	161.120.32
14	100	160	16	10	161.140.31	161.140.32
16	110	170	16	10	161.160.31	161.160.32

160



D mm	I mm	L mm	S mm		ORDER NO. Right-hand rotation	ORDER NO. Left-hand rotation
6	60	120	13	10	160.060.31	160.060.32
8	70	130	13	10	160.080.31	160.080.32
10	80	140	13	10	160.100.31	160.100.32
12	90	150	13	10	160.120.31	160.120.32
14	100	160	13	10	160.140.31	160.140.32
16	110	170	13	10	160.160.31	160.160.32

TECHNICAL DETAILS:

- Long-lasting cutting performance.
- 2 HSS precision ground spiral cutting edges with chip-breaker teeth [Z2R].

APPLICATION:

for cutting mortise slots in soft and hardwood. Used on combined machining centres equipped with chucks.

GUIDE TO MACHINING DEEP SLOTS

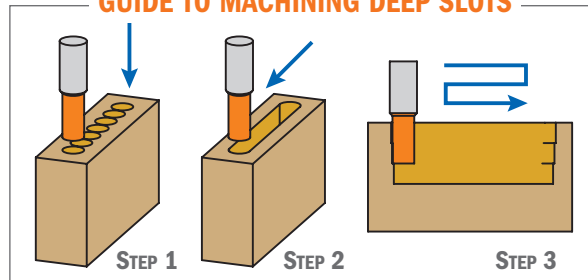

6-Piece Mortising Bit Sets

160 - 161



Ideal for heavy mortise jobs. Made of super strength high speed steel and available in left-hand or right-hand rotation. Safely packaged in a plastic box for protection, these sets are economical and a perfect addition to any workshop.



S mm	D mm		ORDER NO. Right-hand rotation	ORDER NO. Left-hand rotation
16	6-8-10-12-14-16	1	161.001.00	161.001.10
13	6-8-10-12-14-16	1	160.001.00	160.001.10

Carbide Spiral Slot Mortising Bits with Chip-Breaker



161



D mm	I ₁ mm	I mm	L mm	S mm		ORDER NO. Right-hand rotation	ORDER NO. Left-hand rotation
12	25	75	150	16x50	10	161.120.11	161.120.12
16	25	95	170	16x50	10	161.160.11	161.160.12

TECHNICAL DETAILS:

- Super strength steel
- Long-lasting cutting performance.
- 2 precision ground HW cutting edges with chip-breaker teeth
- 1 HW plunge centre tip [Z2R+1]

APPLICATION:

for cutting deep mortise slots in natural soft or medium density wood. For use on machining centres equipped with chucks. RPM 3000~5000

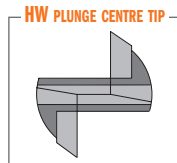

GUIDE TO MACHINING DEEP SLOTS

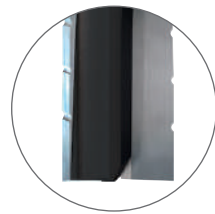
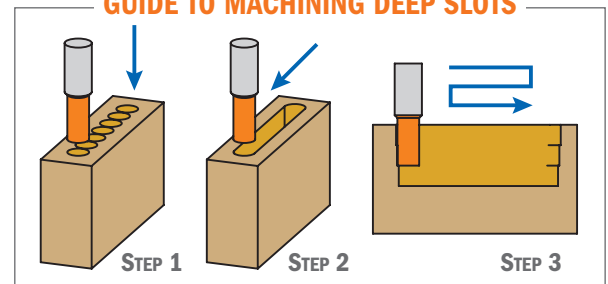

Slot & Mortise Boring Bits

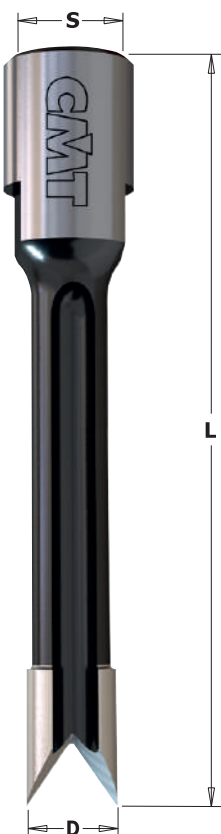

163



D mm	L mm	S mm		ORDER NO. Right-hand rotation
12	100	M12x1	1	163.120.11
14	100	M12x1	1	163.140.11
16	100	M12x1	1	163.160.11

TECHNICAL DETAILS:

- Super strength steel.
- 2 HW precision ground cutting edges [Z2].

APPLICATION:

for cutting slots and mortises in solid wood, wood derivatives and laminates. For use on mortising machines equipped with chucks.

Slot & Mortise Boring Bits



164



D mm	L mm	S mm			ORDER NO. Right-hand rotation	
18	100	M12x1		1	164.180.11	
20	100	M12x1		1	164.200.11	
22	100	M12x1		1	164.220.11	

TECHNICAL DETAILS:

- Super strength steel.
- HW cutting head with precision balanced centre point.
- 2 HW precision ground cutting edges [Z2].
- 2 negatively HW ground spurs [V2].

APPLICATION:

for drilling blind holes in solid wood, wood composites, plastic and laminated materials. For use on slot and mortise machines equipped with chucks.

Slot & Mortise Boring Bits

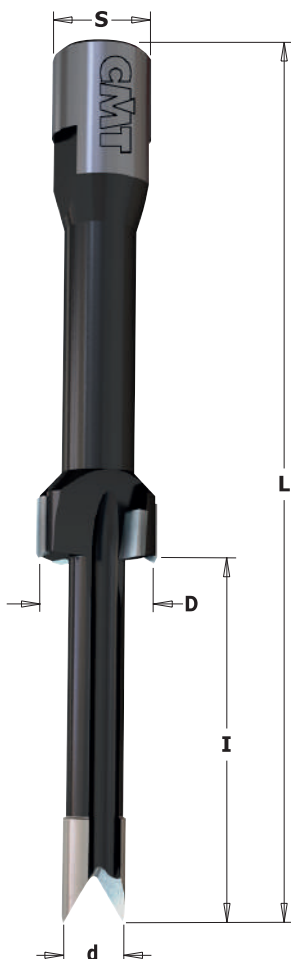

166 - 167



d mm	D mm	I mm	L mm	S mm		ORDER NO. Right-hand rotation	
11	22	62	155	M12x1	1	166.220.11	
12	19	62	155	M12x1	1	167.190.11	

TECHNICAL DETAILS:

- Super strength steel.
- 2 HW precision ground cutting edges [Z2].
- 2 negatively HW ground spurs [V2].

APPLICATION:

for creating mortise slots in solid wood, wood derivatives and laminates. For use on slot and mortise machines equipped with chucks.

Reciprocating Slot Mortising Bits



103



D mm	I mm	L mm	S mm		ORDER NO. Right-hand & Left-hand rotation
6	45	100	16	1	103.060.30
7	45	100	16	1	103.070.30
8	45	100	16	1	103.080.30
9	45	100	16	1	103.090.30
10	55	110	16	1	103.100.30
11	55	110	16	1	103.110.30
12	55	110	16	1	103.120.30
13	55	110	16	1	103.130.30
14	55	110	16	1	103.140.30
15	55	110	16	1	103.150.30
16	55	110	16	1	103.160.30

TECHNICAL DETAILS:

- Long-lasting cutter performance.
- 2 HL precision ground cutting edges [Z2].

APPLICATION:

for cutting deep mortise slots in soft and hardwood. For use on combination machining centres equipped with adaptors and/or chucks.

Reciprocating Slot Mortising Bits

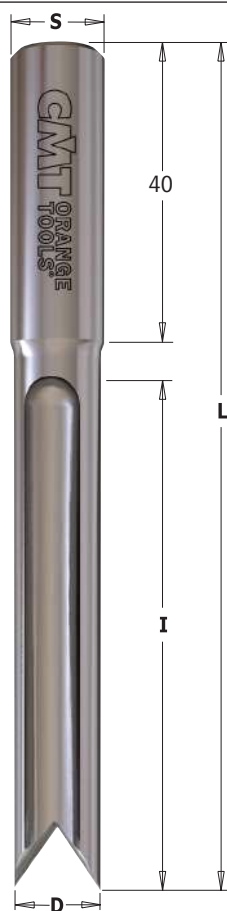

179



D mm	I mm	L mm	S mm		ORDER NO. Right-hand & Left-hand rotation
6	45	90	13	1	179.060.50
7	50	95	13	1	179.070.50
8	50	95	13	1	179.080.50
9	55	100	13	1	179.090.50
10	60	105	13	1	179.100.50
11	65	110	13	1	179.110.50
12	70	115	13	1	179.120.50
13	75	120	13	1	179.130.50

TECHNICAL DETAILS:

- Long-lasting cutter performance.
- 2 HSS precision ground cutting edges [Z2].

APPLICATION:

for cutting deep mortise slots in natural soft or medium density wood. For use on combination machining centres equipped with adaptors and/or chucks.

Reciprocating Slot Mortising Bits



104



D mm	I mm	L mm	S mm		ORDER NO. Right-hand & Left-hand rotation
6	45	100	13	1	104.060.30
7	45	100	13	1	104.070.30
8	45	100	13	1	104.080.30
9	45	100	13	1	104.090.30
10	55	110	13	1	104.100.30
11	55	110	13	1	104.110.30
12	55	110	13	1	104.120.30
13	55	110	13	1	104.130.30
14	55	110	13	1	104.140.30
15	55	110	13	1	104.150.30
16	55	110	13	1	104.160.30

TECHNICAL DETAILS:

- Long-lasting cutting performance
- 4 HL precision ground cutting edges [Z4].

APPLICATION:

for cutting deep mortise slots in soft and medium density wood. For use on mortising machine centres equipped with chucks.

Reciprocating Slot Mortising Bits

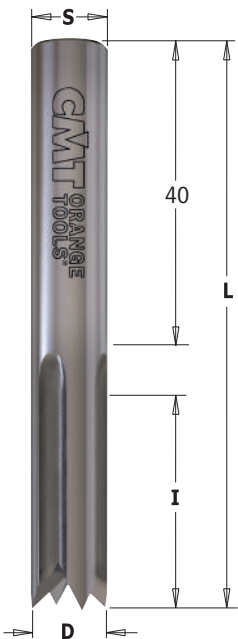

105



D mm	I mm	L mm	S mm		ORDER NO. Right-hand & Left-hand rotation
6	28	73	10	1	105.060.30
7	28	73	10	1	105.070.30
8	28	73	10	1	105.080.30
9	28	73	10	1	105.090.30
10	28	73	10	1	105.100.30
11	28	73	10	1	105.110.30
12	28	73	10	1	105.120.30
13	28	73	10	1	105.130.30
14	28	73	10	1	105.140.30
15	28	73	10	1	105.150.30
16	28	73	10	1	105.160.30

TECHNICAL DETAILS:

- Long-lasting cutting performance
- 4 HL precision ground cutting edges [Z4].

APPLICATION:

for cutting deep mortise slots in natural soft and medium density wood. For use on mortising machine centres equipped with chucks.

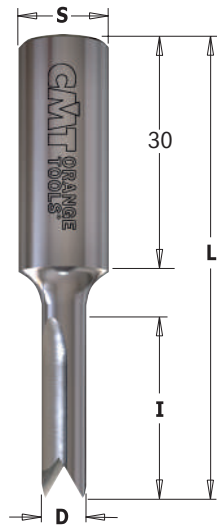

106



D mm	I mm	L mm	S mm	Z		ORDER NO. Right-hand & Left-hand rotation
6	25	60	12	2	1	106.060.30
7	25	60	12	2	1	106.070.30
8	25	60	12	2	1	106.080.30
9	25	60	12	2	1	106.090.30
10	25	60	12	4	1	106.100.30
11	25	60	12	4	1	106.110.30
12	25	60	12	4	1	106.120.30
13	25	60	12	4	1	106.130.30
14	25	60	12	4	1	106.140.30
15	25	60	12	4	1	106.150.30

TECHNICAL DETAILS:

- Long-lasting cutter performance.
- 2 or 4 HL precision ground cutting edges [Z2-Z4].

Slot Mortising Bits



107



D mm	I mm	L mm	S mm		ORDER NO. Right-hand rotation	ORDER NO. Left-hand rotation
6	55	110	16	1	107.060.31	107.060.32
8	55	110	16	1	107.080.31	107.080.32
10	55	110	16	1	107.100.31	107.100.32
12	55	110	16	1	107.120.31	107.120.32
14	60	115	16	1	107.140.31	107.140.32
16	60	115	16	1	107.160.31	107.160.32
18	60	115	16	1	107.180.31	107.180.32
20	60	115	16	1	107.200.31	107.200.32

TECHNICAL DETAILS:

- Long-lasting cutter performance.
- 3 HL precision ground cutting edges [Z3].

APPLICATION:

for cutting mortise slots in natural soft and medium density wood. For use on combination machining centres equipped with chucks.

INDUSTRIAL DOWEL DRILLS

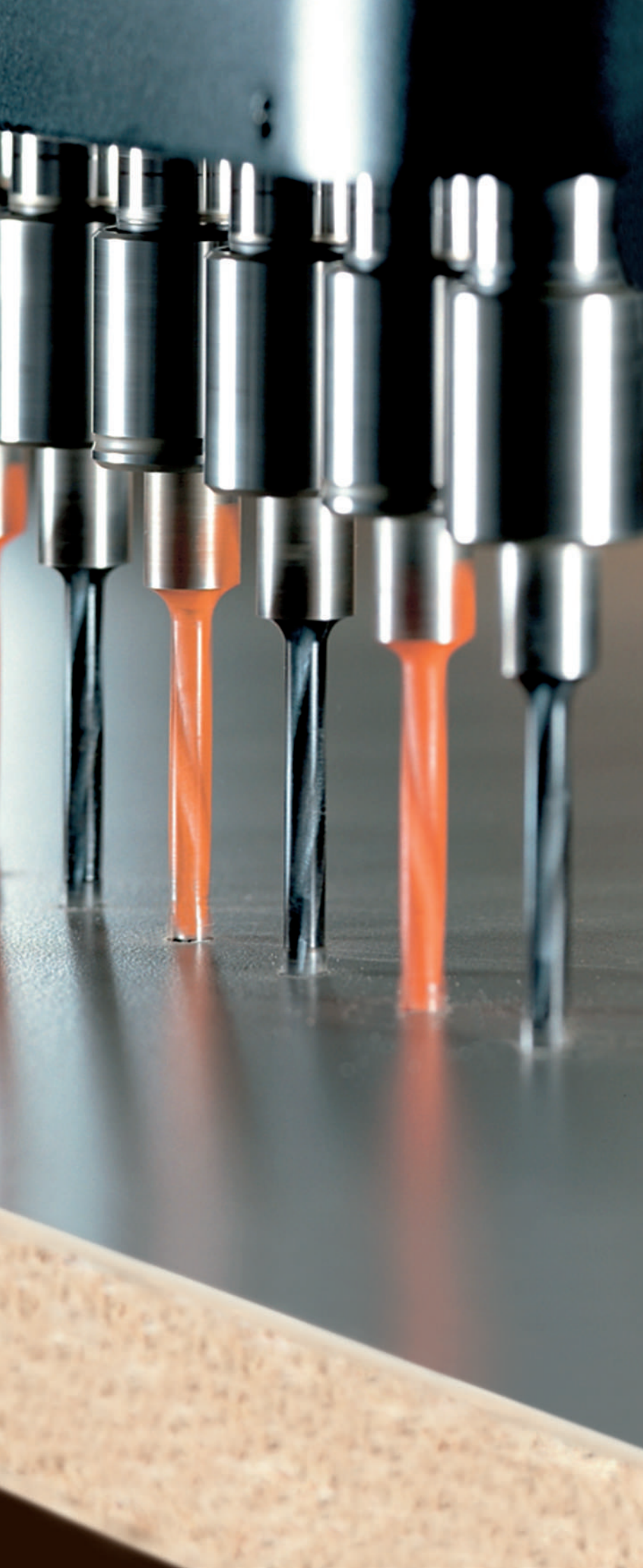

PRODUCTS	PAGE
Adapters	318~320
XTreme Solid Carbide Boring Bits	321~323
XTreme Boring Bits	324~325
Adapters & Bushings for Twist Drills	326
Solid Carbide Twist Drills	327
2 Flute Dowel Drills	328~329
4 Flute Dowel Drills	330~332
Dowel Drills with Countersink	333
Through Hole Dowel Drills	334~335
Countersinks	336
Hinge Boring Bits	337~339
Dowel Drills with Threaded Shank	340~342



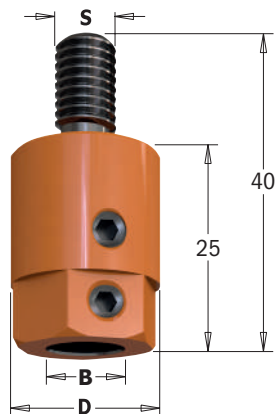

301

RH LH

B mm	D mm	S mm		ORDER NO. Right-hand rotation	ORDER NO. Left-hand rotation
8	16	M8	10	301.080.01	301.080.02
10	19,5	M8	10	301.000.01	301.000.02

FOR USE ON THE FOLLOWING MACHINES:
NOTTMEYER® (older models).

Spare parts



990.006.00

991.062.00

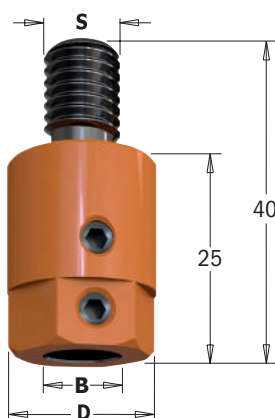

302

RH LH

B mm	D mm	S mm		ORDER NO. Right-hand rotation	ORDER NO. Left-hand rotation
8	16	M10	10	302.080.01	302.080.02
10	19,5	M10	10	302.000.01	302.000.02

FOR USE ON THE FOLLOWING MACHINES:
AYEN®, HOLZMA®, KNOEVENAGEL®, MAYER®, TORWEGGE®.

Spare parts

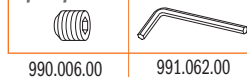

990.006.00

991.062.00

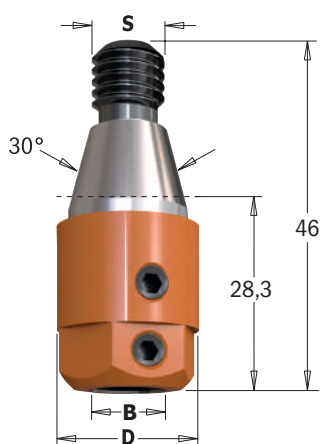

303

RH LH

B mm	D mm	S mm		ORDER NO. Right-hand rotation	ORDER NO. Left-hand rotation
8	16	M10/30°	10	303.080.01	303.080.02
10	19,5	M10/30°	10	303.000.01	303.000.02

FOR USE ON THE FOLLOWING MACHINES:
ALBERTI® (older models).
BALESTRINI®, BILEK®, BUSELLATO® (older models).
SCHLEICHER®, VITAP® (older models).

Spare parts

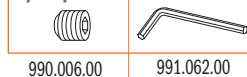

990.006.00

991.062.00

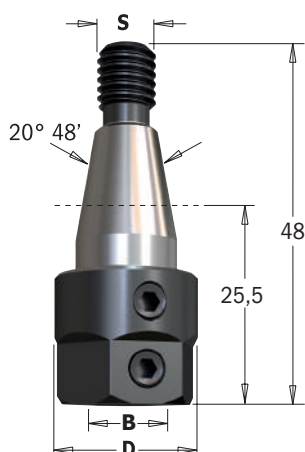

304

RH LH

B mm	D mm	S mm		ORDER NO. Right-hand rotation	ORDER NO. Left-hand rotation
8	16	M8/20° 48'	10	304.080.01	304.080.02
10	19,5	M8/20° 48'	10	304.000.01	304.000.02

FOR USE ON THE FOLLOWING MACHINES:
BALESTRINI®, BILEK®.

Spare parts

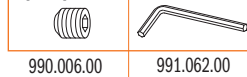

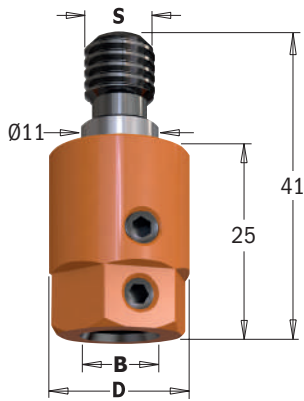

990.006.00

991.062.00



305





B mm	D mm	S mm		ORDER NO. Right-hand rotation	ORDER NO. Left-hand rotation
8	16	M10/11		305.080.01	305.080.02
10	19,5	M10/11		305.000.01	305.000.02

FOR USE ON THE FOLLOWING MACHINES:

BIESSE® (older models).
 MASTERWOOD® (Zangheri & Boschetti).
 MORBIDELLI®, TORWEGGE®, VITAP® (new design).
 WEEKE®.

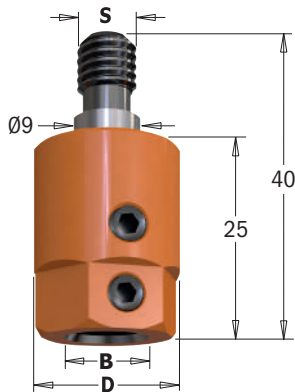

Spare parts

	
990.006.00	991.062.00



358





B mm	D mm	S mm		ORDER NO. Right-hand rotation	ORDER NO. Left-hand rotation
8	16	M8/9		358.080.01	358.080.02
10	19,5	M8/9		358.000.01	358.000.02

FOR USE ON THE FOLLOWING MACHINES:

MASTERWOOD® (Zangheri & Boschetti).
 MORBIDELLI®, NOTTMEYER® (new design).

Spare parts

	
990.006.00	991.062.00



359





B mm	D mm	S mm		ORDER NO. Right-hand rotation	ORDER NO. Left-hand rotation
10	19,5	M10		359.000.01	359.000.02

FOR USE ON THE FOLLOWING MACHINES:

SCHEER®.

Spare parts

	
990.006.00	991.062.00



360.001





B mm	d mm	D mm		ORDER NO. Right-hand rotation	ORDER NO. Left-hand rotation
10	20	15		360.001.01	360.001.02

FOR USE ON THE FOLLOWING MACHINES:

BIESSE® machines with quick drill change chuck.

Spare parts

	
990.007.00	991.067.00



360.101

LH RH

B mm	d mm	D mm		ORDER NO. Right-hand & Left-hand rotation
10	17,5	18	10	360.101.00

FOR USE ON THE FOLLOWING MACHINES:
VITAP®.

Spare parts	
990.015.00	991.062.00



360.201

LH RH

B mm	d mm	D mm		ORDER NO. Right-hand & Left-hand rotation
10	19,5	20	10	360.201.00

FOR USE ON THE FOLLOWING MACHINES:
MORBIDELLI®.

Spare parts	
990.009.00	991.067.00



360.301

LH RH

B mm	d mm	D mm		ORDER NO. Right-hand & Left-hand rotation
10	19,5	20	10	360.301.00

FOR USE ON THE FOLLOWING MACHINES:
MASTERWOOD®, MAGGI®, GRIGGIO®.

Spare parts	
990.015.00	991.062.00



360.401

LH RH

B mm	d mm	D mm		ORDER NO. Right-hand & Left-hand rotation
10	20	17	10	360.401.00

FOR USE ON THE FOLLOWING MACHINES:
WEEKE®.

Spare parts	
990.009.00	991.067.00



990.088

LH RH

DESCRIPTION		ORDER NO. Right-hand & Left-hand rotation
Retaining screw for WEEKE® machines	10	990.088.00

LINE	XTREME FLAT	XTREME	XTREME	INDUSTRIAL
PERFORMANCE	SUPERIOR ★★★★★	SUPERIOR ★★★★★	EXCELLENT ★★★★★	VERY GOOD ★★★
BIT				
DESCRIPTION	Designed for heavy duty drilling in Large-Scale Industrial Manufacturing ensuring high impact resistance and greater durability.	Designed for heavy duty drilling in Large-Scale Industrial Manufacturing ensuring high impact resistance and greater durability.	Designed for heavy-duty to medium-duty drilling in large-scale to medium-scale industrial manufacturing ensuring high impact resistance and greater durability.	Designed for medium-duty to light-duty drilling in medium-scale to small-scale industrial manufacturing ensuring rigorous impact resistance and good durability.
USER	LARGE-SCALE INDUSTRIAL MANUFACTURING	LARGE-SCALE INDUSTRIAL MANUFACTURING	LARGE-SCALE TO MEDIUM-SCALE INDUSTRIAL MANUFACTURING	MEDIUM-SCALE TO SMALL-SCALE INDUSTRIAL MANUFACTURING
RECOMMENDED USE	INDUSTRIAL PRODUCTION	INDUSTRIAL PRODUCTION	INDUSTRIAL/REMODELER	REMODELER
MATERIALS	Ideal for chipboard, MDF, HDF and laminates. Nonprotruding center-point and spurs make this tool perfect for low-thickness panels.	Ideal for chipboard, MDF, HDF and laminates.	Excellent for both hard and soft wood. Great for chipboard, MDF, HDF and laminates.	Excellent for both hard and soft wood. Good for chipboard, MDF, and laminates.
SHARPENING & MAINTENANCE	Flat edges with reinforced spurs allow perfect finishing and prolonged drilling. XTREME FLAT SHARPENING	Specially designed reinforced spurs allow for impeccable finishing during operations involving high-speed cutting feed. XTREME SHARPENING	Specially designed reinforced spurs allow for impeccable finishing during operations involving high-speed cutting feed. XTREME SHARPENING	Standard design with negatively ground spurs providing good quality finishing without chipping. NEGATIVELY GROUND SPURS
CARBIDE	INDUSTRIAL CHROMIUM MICROGRAIN CARBIDE The premium quality carbide produces clean bores with no rough edges and maintains a balanced center point. In addition to its safety features, Chromium Micrograin Carbide guarantees exceptional resistance to fatigue and abrasion and allows for an infinite number of resharpenings.	INDUSTRIAL CHROMIUM MICROGRAIN CARBIDE The special chromium enhanced carbide produces clean bores with no rough edges and maintains a balanced center point. In addition to its safety features, Chromium Micrograin Carbide guarantees exceptional resistance to fatigue and abrasion and allows for an infinite number of resharpenings.	INDUSTRIAL SINTERHIP HI-DENSITY CARBIDE The unique tip is made of high quality carbide enhanced via Sinterhip (hot isostatic pressing). This process guarantees long lasting performance and exceptionally clean bores.	INDUSTRIAL GRADE CARBIDE Fine and medium grain carbide grade guarantee reliable prolonged use.
COATING	 SOLID TUNGSTEN CARBIDE	 SOLID TUNGSTEN CARBIDE	CMT P.T.F.E. COATING provides a non-stick surface preventing resin, glue or sludge residue accumulation on the bit body. Baked at 420°, this unique industrial material is specifically designed to fit woodworking tool requirements.	CMT P.T.F.E. COATING provides a non-stick surface preventing resin, glue or sludge residue accumulation on the bit body. Baked at 420°, this unique industrial material is specifically designed to fit woodworking tool requirements.
PRICE RANGE	HIGH	HIGH	MEDIUM/HIGH	MEDIUM

Solid Carbide Dowel Drills

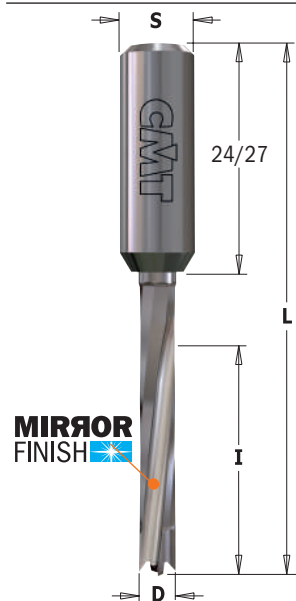

311.71/72 XTREME FLAT SHARPENING

HWM LONG LIFE Z2 V2 RH LH

D mm	I mm	L mm	S mm		ORDER NO.	ORDER NO.
					Right-hand rotation	Left-hand rotation
5	30	70	10x27	50	311.050.71	311.050.72
6	30	70	10x27	50	311.060.71	311.060.72
7	30	70	10x27	50	311.070.71	311.070.72
8	30	70	10x24	50	311.080.71	311.080.72
10	30	70	10x26	50	311.100.71	311.100.72

TECHNICAL DETAILS:

- Premium quality super strength steel shank for improved resistance and durability
- Flute length in premium quality HWM
- 2 cutting edges [Z2] + 2 curved ground spurs [V2]
- 2 spiral flutes
- Parallel shank with driving flat and adjustable screw length
- Recommended feed speed 1÷ 4m/minute - RPM 6000

APPLICATION:

ideal for chipboard, MDF, HDF and laminates. No center-point or spurs means perfect bores in low-thickness panels. For use on boring machines equipped with adapters/chucks.

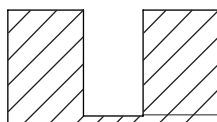

Flat sharpening with no center-point or spurs

Spare parts	Optional
 990.003.00	 990.088.00

XTREME FLAT SHARPENING

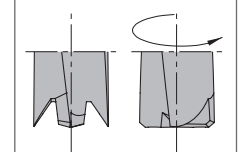

CMT's new high quality dowel drills guarantee excellent performance and extra-long life!

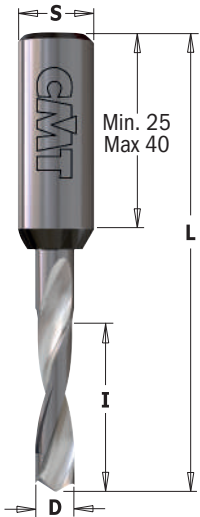

310.21/22 XTREME



D mm	I mm	L mm	S mm		ORDER NO. Right-hand rotation	ORDER NO. Left-hand rotation
1,3	5	57,5	10x30	50	310.013.20*	
2	12	57,5	10x27	50	310.020.21	310.020.22
3	9	57,5	10x40	50	310.530.21	310.530.22
3	18	57,5	10x25	50	310.030.21	310.030.22
4	20	57,5	10x27	50	310.040.21	310.040.22
5	22	57,5	10x27	50	310.050.21	310.050.22
6	22	57,5	10x27	50	310.060.21	310.060.22
6,35 (1/4")	22	57,5	10x27	50	310.064.21	310.064.22
8	22	57,5	10x27	50	310.080.21	310.080.22
10	22	57,5	10x25	50	310.100.21	310.100.22

* Boring bit for panel preboring.
Suitable for both right-hand and left-hand rotation.

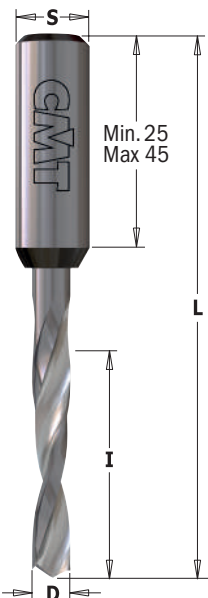
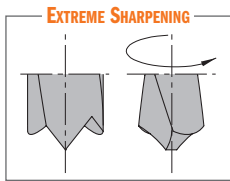
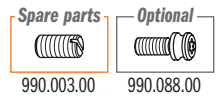

311.21/22 XTREME



D mm	I mm	L mm	S mm		ORDER NO. Right-hand rotation	ORDER NO. Left-hand rotation
1,3	5	70	10x45	50	311.013.20*	
2	12	70	10x40	50	311.020.21	311.020.22
3	18	70	10x42	50	311.030.21	311.030.22
3,5	18	70	10x39	50	311.035.21	311.035.22
4	30	70	10x28	50	311.040.21	311.040.22
5	30	70	10x30	50	311.050.21	311.050.22
6	30	70	10x27	50	311.060.21	311.060.22
6,35 (1/4")	30	70	10x30	50	311.064.21	311.064.22
7	35	70	10x25	50	311.070.21	311.070.22
8	35	70	10x25	50	311.080.21	311.080.22
10	35	70	10x25	50	311.100.21	311.100.22

* Boring bit for panel preboring.
Suitable for both right-hand and left-hand rotation.

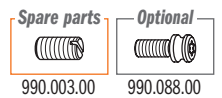

TECHNICAL DETAILS:

- Premium quality super-strength steel shank.
- High quality HWM body
- Centre point
- 2 cutting edges [Z2].
- 2 spiral flutes
- 2 curved, negatively ground spurs [V2].
- Parallel shank with driving flat and adjustable screw length.

APPLICATION:

for drilling blind holes in solid wood, wood derivatives and laminates.
For use on boring machines equipped with adaptors and/or with chucks

Perfect for all materials and long-lasting performance!

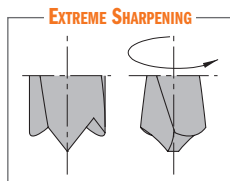

Grinding Wheels for XTreme Sharpening



01.02

D mm	DESCRIPTION	DIMENSION mm	B mm		ORDER NO.
Ø3 a 7	Grinding wheel for resharpening	Ø125x5,5	Ø20	1	01.02.0316
Ø8 a 10	Grinding wheel for resharpening	Ø125x7	Ø20	1	01.02.0317

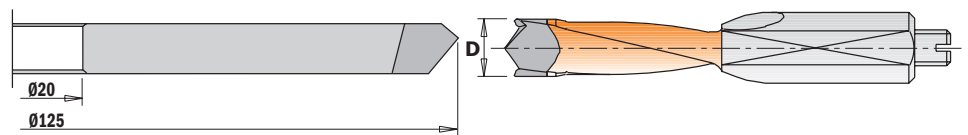

Solid Carbide Dowel Drills for Through Holes

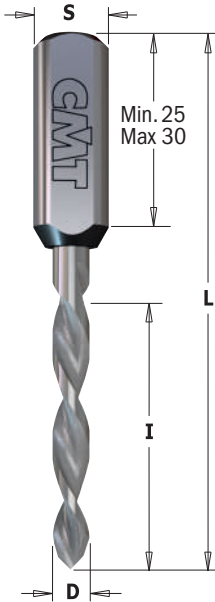

314.21/22 EXTREME



D mm	I mm	L mm	S mm		ORDER NO. Right-hand rotation	ORDER NO. Left-hand rotation
*3	27	70	10x30	50	314.030.21	314.030.22
4	35	70	10x25	50	314.040.21	314.040.22
5	35	70	10x25	50	314.050.21	314.050.22
6	35	70	10x25	50	314.060.21	314.060.22
7	35	70	10x25	50	314.070.21	314.070.22
8	35	70	10x25	50	314.080.21	314.080.22
10	35	70	10x27	50	314.100.21	314.100.22

new

* "V" point 60° sharpening

For panels with maximum 20-30mm in thickness

TECHNICAL DETAILS:

- Premium quality super-strength steel shank
- High quality HWM body
- 2 precision ground cutting edges [Z2] - double angle
- 2 spiral flutes.
- Parallel shank with driving flat and adjustable screw length.

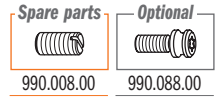

APPLICATION:

for drilling through holes in solid wood, wood derivatives and laminates.
For use on boring machine centres equipped with adaptors and/or chucks.

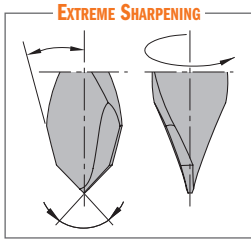

Solid Carbide Dowel Drills

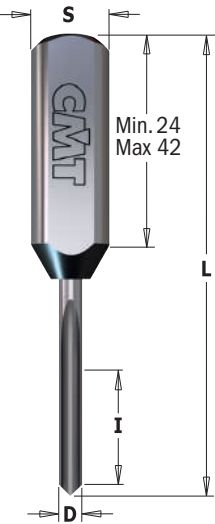

382 EXTREME



D mm	I mm	L mm	S mm		ORDER NO. Right-hand & Left-hand rotation
2	12	57,5	10x30	50	382.2057
2	12	70	10x42	50	382.2070
2,5	16	57,5	10x24	50	382.2557
2,5	16	70	10x35	50	382.2570
3	15	57,5	10x26	50	382.3057
3	25	70	10x26	50	382.3070
3,5	18	57,5	10x24	50	382.3557
3,5	18	70	10x36	50	382.3570
5	25	57,5	10x25	50	382.5057
5	35	70	10x25	50	382.5070

TECHNICAL DETAILS:

- Premium quality HWM.
- Cutting head with precision balanced centre point.
- 1 cutting edge [Z1].
- Parallel shank with driving flat and adjustable screw length.

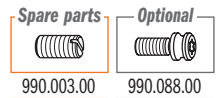

APPLICATION:

for drilling blind holes in solid wood, wood derivatives, plastic, laminates and melamine.
For use on boring machine centres, point-to-point machines and hand-held routers equipped with adaptors and/or chucks.

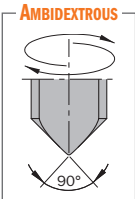

SECURITY TIPS:

These boring bits require more power compared to tradition dowel drills.
The number of boring bits to be used in a single drilling unit depends on the machine power.

Dowel Drills

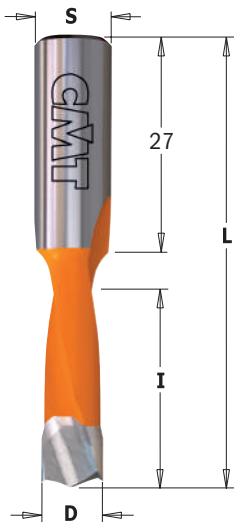

310.41/42 XTREME



D mm	I mm	L mm	S mm		ORDER NO. Right-hand rotation	ORDER NO. Left-hand rotation
5	27	57,5	10x27	50	310.050.41	310.050.42
6	27	57,5	10x27	50	310.060.41	310.060.42
7	27	57,5	10x27	50	310.070.41	310.070.42
8	27	57,5	10x27	50	310.080.41	310.080.42
9	27	57,5	10x27	50	310.090.41	310.090.42
10	27	57,5	10x27	50	310.100.41	310.100.42

TECHNICAL DETAILS:

- Premium quality super-strength steel
- Orange or black P.T.F.E. coating
- High quality extra-fine micrograin carbide body
- 2 cutting edges [Z2] - double angle
- 2 spiral flutes
- 2 curved, negatively ground spurs [V2]
- Parallel shank with driving flat and adjustable screw length.

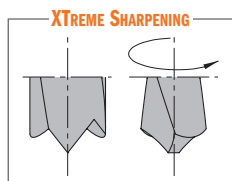
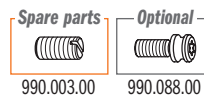

APPLICATION:

for drilling blind holes in solid wood, wood derivatives and laminates.
For use on boring machines equipped with adaptors and/or chucks.

Dowel Drills

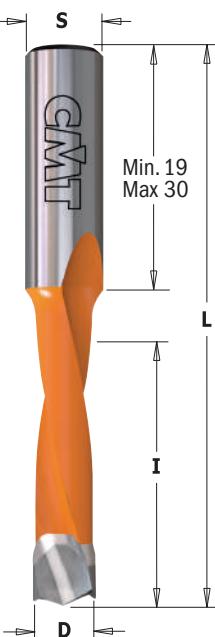

311.41/42 XTREME



D mm	I mm	L mm	S mm		ORDER NO. Right-hand rotation	ORDER NO. Left-hand rotation
5	35	70	10x30	50	311.050.41	311.050.42
6	35	70	10x30	50	311.060.41	311.060.42
7	35	70	10x30	50	311.070.41	311.070.42
8	35	70	10x30	50	311.080.41	311.080.42
8	45	70	10x19	50	311.580.41*	311.580.42*
9	35	70	10x30	50	311.090.41	311.090.42
10	35	70	10x30	50	311.100.41	311.100.42
12	35	70	10x30	10	311.120.41	311.120.42

TECHNICAL DETAILS:

- Premium quality super-strength steel
- High quality extra-fine micrograin carbide body
- Orange or black P.T.F.E. coating
- 2 cutting edges [Z2].
- 2 curved, negatively ground spurs [V2].
- 2 spiral flutes.
- Parallel shank with driving flat and adjustable screw length.

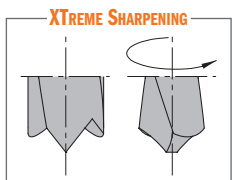
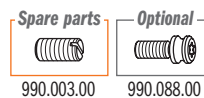

APPLICATION:

for drilling blind holes in solid wood, wood derivatives, plastics and laminates.
For use on boring machines equipped with adaptors and/or chucks.

* Drill bits designed to fit HÄFELE® one-piece lxconnect SC 8/60 spreading connector.

Perfect for all materials and long-lasting performance!

CMT announces the new series of solid carbide boring bits, now available from their extensive industrial line. These bits are entirely made of premium quality super micrograin carbide from CERATIZIT® in Luxemburg.

The entire series offers several design features:

- the unique tip has curved, negatively ground spurs to produce exceptionally clear bores with no rough-edges.
- Centre point balanced;
- the cylindrical head is bigger than traditional tips and is extremely resistant to prolonged use.

It lasts longer between sharpenings;

- the plunge edge runs all the way to the centre of the bit to reduce drilling resistance and increase production speed;
- the solid carbide construction guarantees an almost infinite number of resharpenings, and since it is a solid unit of carbide, it offers extra safety features;
- ideal for hardwood and difficult composites such as particle boards, MDF and veneered wood.
- excellent performance on high-speed boring units and CNC routers.

Dowel Drills for Through Holes

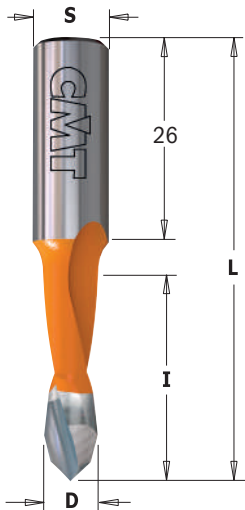

313.41/42 XTREME



D mm	I mm	L mm	S mm		ORDER NO. Right-hand rotation	ORDER NO. Left-hand rotation
5	27	57,5	10x26	50	313.050.41	313.050.42
8	27	57,5	10x26	50	313.080.41	313.080.42

For panels 20mm maximum in thickness

TECHNICAL DETAILS:

- Super-strength steel.
- Spiral portion coated with orange or black P.T.F.E.
- Extra-fine micrograin carbide spiral portion with centre point.
- HW head with precision balanced centre point.
- 2 precision ground cutting edges [Z2].
- Double angle.
- 2 spiral flutes.
- Parallel shank with driving flat and length adjusting screw.

APPLICATION:

for drilling through holes in solid wood, wood derivatives and laminates.
For use on boring machines equipped with adaptors and/or chucks

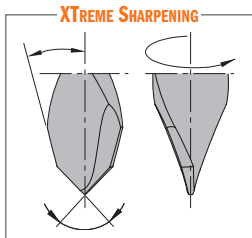
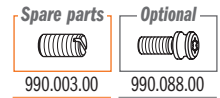

Dowel Drills for Through Holes

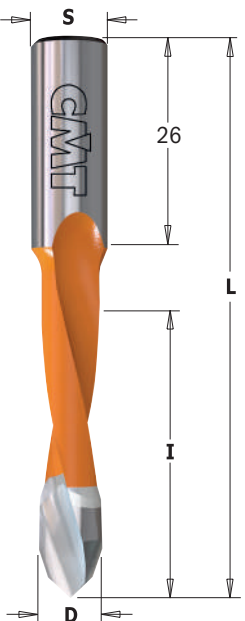

314.41/42 XTREME



D mm	I mm	L mm	S mm		ORDER NO. Right-hand rotation	ORDER NO. Left-hand rotation
5	35	70	10x26	50	314.050.41	314.050.42
6	35	70	10x26	50	314.060.41	314.060.42
7	35	70	10x26	50	314.070.41	314.070.42
8	35	70	10x26	50	314.080.41	314.080.42
10	35	70	10x26	50	314.100.41	314.100.42

For panels 30mm maximum in thickness

TECHNICAL DETAILS:

- Super-strength steel.
- Spiral portion coated with orange or black P.T.F.E.
- Extra-fine micrograin carbide spiral portion with centre point.
- HW head with precision balanced centre point.
- 2 precision ground cutting edges [Z2].
- Double angle.
- 2 spiral flutes.
- Parallel shank with driving flat and length adjusting screw.

APPLICATION:

for drilling through holes in solid wood, wood derivatives and laminates.
For use on boring machines equipped with adaptors and/or chucks.

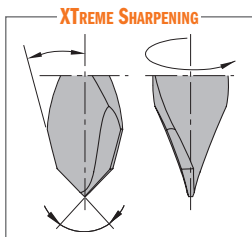
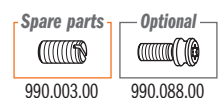

Perfect for all materials and long-lasting performance!

CMT announces the new series of solid carbide boring bits, now available from their extensive industrial line. These bits are entirely made of premium quality super micrograin carbide from CERATIZIT® in Luxemburg.

The entire series offers several design features:

- the unique tip has curved, negatively ground spurs to produce exceptionally clear bores with no rough-edges.
- Centre point balanced;
- the cylindrical head is bigger than traditional tips and is extremely resistant to prolonged use.

It lasts longer between sharpenings;

- the plunge edge runs all the way to the centre of the bit to reduce drilling resistance and increase production speed;
- the solid carbide construction guarantees an almost infinite number of resharpenings, and since it is a solid unit of carbide, it offers extra safety features;
- ideal for hardwood and difficult composites such as particle boards, MDF and veneered wood.
- excellent performance on high-speed boring units and CNC routers.



364

B mm	L mm	S mm		ORDER NO.
2	38	10x20	10	364.020.00
2,5	38	10x20	10	364.025.00
3	38	10x20	10	364.030.00
3,2	38	10x20	10	364.032.00
3,5	38	10x20	10	364.035.00
4	38	10x20	10	364.040.00
4,5	38	10x20	10	364.045.00
5	38	10x20	10	364.050.00

For use with the following items: **363** HWM

TECHNICAL DETAILS:

- Super-strength steel.
- Quick and secure assembly on twist drills.
- Precision relief.
- Parallel shank with driving flat.

APPLICATION:

for use with twist drills with common shank and bushing diameter.
For use on boring machines equipped with adapters and/or chucks.



Bushings for Twist Drills



365

B mm	L mm	S mm		ORDER NO.
2	23	10	50	365.020.00
2,5	23	10	50	365.025.00
3	23	10	50	365.030.00
3,2	23	10	50	365.032.00
3,5	23	10	50	365.035.00
4	23	10	50	365.040.00
4,5	23	10	50	365.045.00
5	23	10	50	365.050.00
6	23	10	50	365.060.00

For use with the following items: **363** HWM

TECHNICAL DETAILS:

- Super-strength steel.
- Shank with driving flat.
- Axial cuttings for cylindrical drill clamps.

APPLICATION:

for use with twist drills with common shank and bushing diameter. For use on boring machines equipped with adapters and/or chucks.

ASSEMBLY ILLUSTRATION

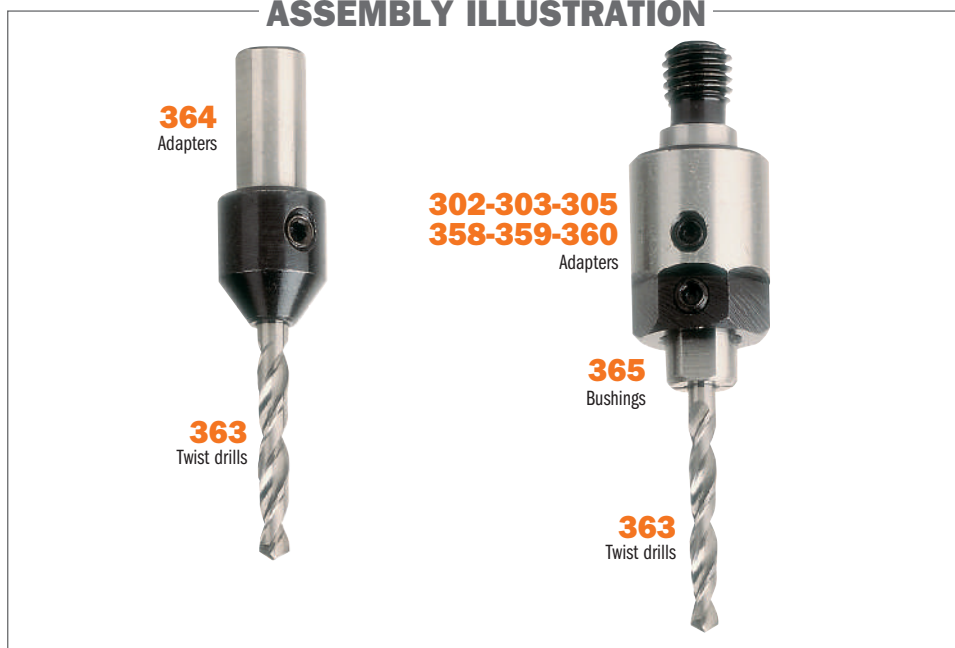

Solid Carbide Twist Drills "V" Point 120° Sharpening

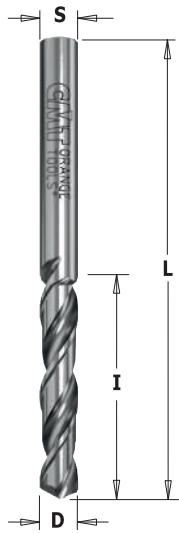

363.11/12

HWM LONG LIFE Z2 RH LH

S=D mm	I mm	L mm		ORDER NO. Right-hand rotation	ORDER NO. Left-hand rotation
2	25	50		363.020.11	363.020.12
2,5	27	55	50	363.025.11	363.025.12
3	27	55	50	363.030.11	363.030.12
3,2	27	55	50	363.032.11	363.032.12
3,5	27	55	50	363.035.11	363.035.12
4	27	55	50	363.040.11	363.040.12
4,5	28	60	50	363.045.11	363.045.12
5	28	60	50	363.050.11	363.050.12

For use with the following items: **364-365**

TECHNICAL DETAILS:

- Premium quality HWM.
- 2 precision ground cutting edges [Z2].
- 2 spiral flutes.
- Common shank and drilling diameter (S=D).

APPLICATION:

for drilling through holes in solid wood, wood derivatives and laminates.
For use on boring machines equipped with adapters and/or chucks.

Solid Carbide Twist Drills "V" Point 60° Sharpening

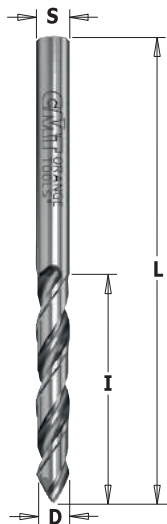

363.41/42

HWM LONG LIFE Z2 RH LH

S=D mm	I mm	L mm		ORDER NO. Right-hand rotation	ORDER NO. Left-hand rotation
2,5	27	55		363.025.41	363.025.42
3	27	55	50	363.030.41	363.030.42
3,5	27	55	50	363.035.41	363.035.42
4	27	55	50	363.040.41	363.040.42

For use with the following items: **364-365**

TECHNICAL DETAILS:

- Premium quality HWM.
- 2 precision ground cutting edges [Z2].
- 2 spiral flutes.
- Common shank and drilling diameter (S=D).

APPLICATION:

for drilling through holes in solid wood, wood derivatives and laminates.
For use on boring machines equipped with adapters and/or chucks.

Solid Carbide Twist Drills Negatively Ground Spurs Sharpening

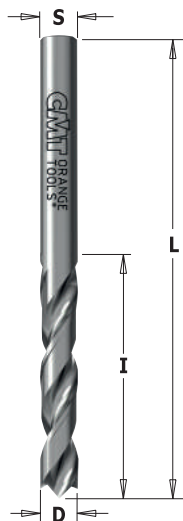

363.21/22 XTREME

HWM LONG LIFE Z2 RH LH

S=D mm	I mm	L mm		ORDER NO. Right-hand rotation	ORDER NO. Left-hand rotation
2,5	27	55		363.025.21	363.025.22
3	27	55	50	363.030.21	363.030.22
4	27	55	50	363.040.21	363.040.22
5	28	60	50	363.050.21	363.050.22

For use with the following items: **364-365**

TECHNICAL DETAILS:

- Premium quality HWM.
- 2 precision ground cutting edges [Z2].
- 2 spiral flutes.
- Common shank and drilling diameter (S=D).

APPLICATION:

for drilling blind holes in solid wood, wood derivatives and laminates.
For use on boring machines equipped with adapters and/or chucks.

2 Flute Dowel Drills

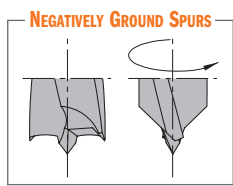
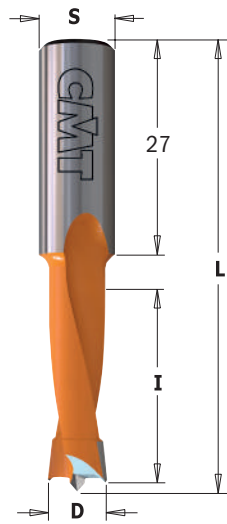

310

HW Z2 V2 RH LH

D mm	I mm	L mm	S mm		ORDER NO. Right-hand rotation	ORDER NO. Left-hand rotation
4	27	57,5	10x27	50	310.040.11	310.040.12
4,5	27	57,5	10x27	50	310.045.11	310.045.12
4,76	27	57,5	10x27	50	310.047.11	310.047.12
5	27	57,5	10x27	50	310.050.11	310.050.12
5,1	27	57,5	10x27	50	310.051.11	310.051.12
5,2	27	57,5	10x27	50	310.052.11	310.052.12
5,55	27	57,5	10x27	50	310.055.11	310.055.12
6	27	57,5	10x27	50	310.060.11	310.060.12
6,35	27	57,5	10x27	50	310.064.11	310.064.12
6,5	27	57,5	10x27	50	310.065.11	310.065.12
7	27	57,5	10x27	50	310.070.11	310.070.12
8	27	57,5	10x27	50	310.080.11	310.080.12
8,2	27	57,5	10x27	50	310.082.11	310.082.12
9	27	57,5	10x27	50	310.090.11	310.090.12
9,52	27	57,5	10x27	50	310.095.11	310.095.12
10	27	57,5	10x27	50	310.100.11	310.100.12
11	27	57,5	10x27	10	310.110.11	310.110.12
12	27	57,5	10x27	10	310.120.11	310.120.12
12,7	27	57,5	10x27	10	310.127.11	310.127.12
13	27	57,5	10x27	10	310.130.11	310.130.12
14	27	57,5	10x27	10	310.140.11	310.140.12
15	27	57,5	10x27	10	310.150.11	310.150.12
16	27	57,5	10x27	10	310.160.11	310.160.12

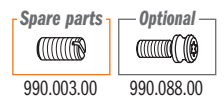

2 Flute Dowel Drills

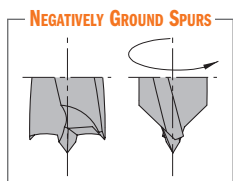
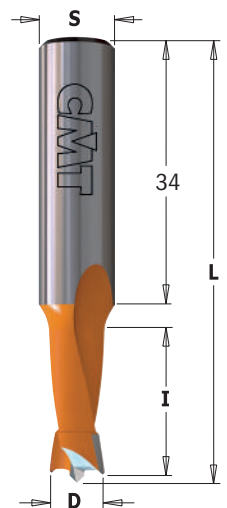

361

HW Z2 V2 RH LH

D mm	I mm	L mm	S mm		ORDER NO. Right-hand rotation	ORDER NO. Left-hand rotation
5	18	57,5	10x34	50	361.050.11	361.050.12
6	18	57,5	10x34	50	361.060.11	361.060.12
7	18	57,5	10x34	50	361.070.11	361.070.12
8	18	57,5	10x34	50	361.080.11	361.080.12
10	18	57,5	10x34	50	361.100.11	361.100.12

TECHNICAL DETAILS:

- Super-strength steel.
- Spiral portion coated with orange or black P.T.F.E.
- HW head with precision balanced centre point.
- 2 HW precision ground cutting edges [Z2].
- 2 negatively ground spurs [V2]
- 2 spiral flutes.
- Parallel shank with driving flat and length adjusting screw.

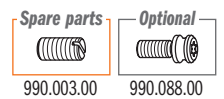

APPLICATION:

used on boring machines equipped with adapters or chucks.
Used to drill blind holes in solid wood, wood composites, plastic and laminated materials.

2 Flute Dowel Drills

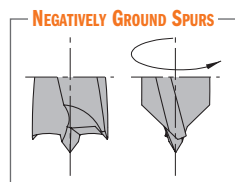
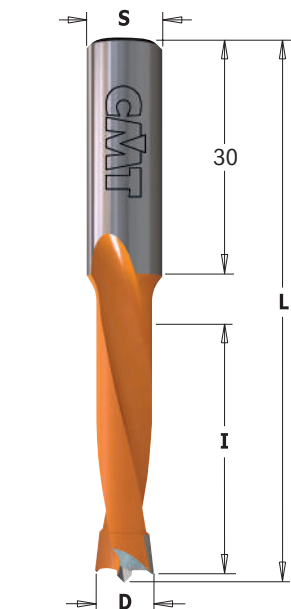

311



D mm	I mm	L mm	S mm		ORDER NO. Right-hand rotation	ORDER NO. Left-hand rotation
4	35	70	10x30	50	311.040.11	311.040.12
4,5	35	70	10x30	50	311.045.11	311.045.12
4,76	35	70	10x30	50	311.047.11	311.047.12
5	35	70	10x30	50	311.050.11	311.050.12
5,1	35	70	10x30	50	311.051.11	311.051.12
5,2	35	70	10x30	50	311.052.11	311.052.12
5,55	35	70	10x30	50	311.055.11	311.055.12
6	35	70	10x30	50	311.060.11	311.060.12
6,35	35	70	10x30	50	311.064.11	311.064.12
6,5	35	70	10x30	50	311.065.11	311.065.12
7	35	70	10x30	50	311.070.11	311.070.12
8	35	70	10x30	50	311.080.11	311.080.12
8,2	35	70	10x30	50	311.082.11	311.082.12
9	35	70	10x30	50	311.090.11	311.090.12
9,52	35	70	10x30	50	311.095.11	311.095.12
10	35	70	10x30	50	311.100.11	311.100.12
11	35	70	10x30	10	311.110.11	311.110.12
11,1	35	70	10x30	10	311.111.11	311.111.12
12	35	70	10x30	10	311.120.11	311.120.12
12,7	35	70	10x30	10	311.127.11	311.127.12
13	35	70	10x30	10	311.130.11	311.130.12
14	35	70	10x30	10	311.140.11	311.140.12
15	35	70	10x30	10	311.150.11	311.150.12
16	35	70	10x30	10	311.160.11	311.160.12

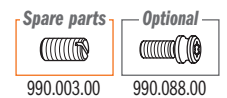

2 Flute Dowel Drills

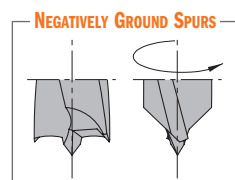
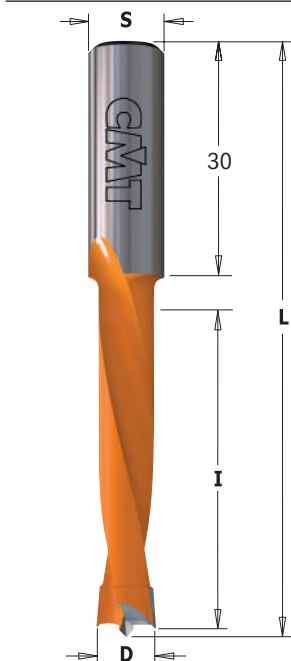

362



D mm	I mm	L mm	S mm		ORDER NO. Right-hand rotation	ORDER NO. Left-hand rotation
5	44	77	10x30	50	362.050.11	362.050.12
6	44	77	10x30	50	362.060.11	362.060.12
7	44	77	10x30	50	362.070.11	362.070.12
8	44	77	10x30	50	362.080.11	362.080.12
10	44	77	10x30	50	362.100.11	362.100.12
12	44	77	10x30	10	362.120.11	362.120.12

TECHNICAL DETAILS:

- Super-strength steel.
- Spiral portion coated with orange or black P.T.F.E.
- HW head with precision balanced centre point.
- 2 HW precision ground cutting edges [Z2].
- 2 negatively ground spurs [V2].
- 2 spiral flutes.
- Parallel shank with driving flat and length adjusting screw.

APPLICATION:

used on boring machines equipped with adapters or chucks.
Used to drill blind holes in solid wood, wood composites, plastic and laminated materials.

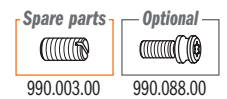

4 Flute Dowel Drills

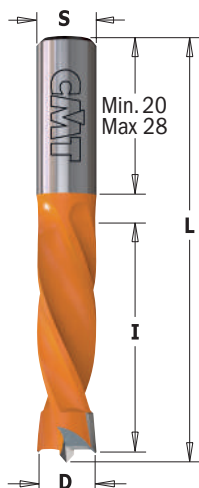

306

HW HWM Z2 V2 RH LH

D mm	I mm	L mm	S mm		ORDER NO. Right-hand rotation	ORDER NO. Left-hand rotation
• 3	18	55,5	8x28	50	306.030.21	
5	30	55,5	8x20	50	306.050.11	306.050.12
5,55	30	55,5	8x20	50	306.055.11	306.055.12
6	30	55,5	8x20	50	306.060.11	306.060.12
6,35	30	55,5	8x20	50	306.064.11	306.064.12
7	30	55,5	8x20	50	306.070.11	306.070.12
8	30	55,5	8x20	50	306.080.11	306.080.12
9	30	55,5	8x20	50	306.090.11	306.090.12
10	30	55,5	8x20	50	306.100.11	306.100.12
12	30	55,5	8x20	50	306.120.11	306.120.12

• **HWM**

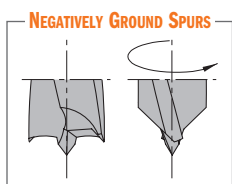
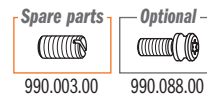

4 Flute Dowel Drills

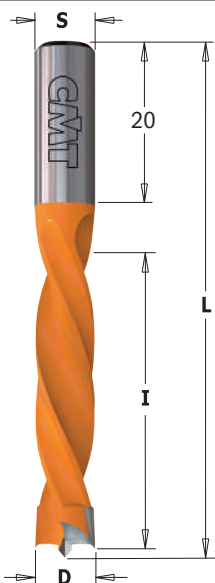

307

HW Z2 V2 RH LH

D mm	I mm	L mm	S mm		ORDER NO. Right-hand rotation	ORDER NO. Left-hand rotation
5	40	67	8x20	50	307.050.11	307.050.12
5,55	40	67	8x20	50	307.055.11	307.055.12
6	40	67	8x20	50	307.060.11	307.060.12
6,35	40	67	8x20	50	307.064.11	307.064.12
7	40	67	8x20	50	307.070.11	307.070.12
8	40	67	8x20	50	307.080.11	307.080.12
9	40	67	8x20	50	307.090.11	307.090.12
9,52	40	67	8x20	50	307.095.11	307.095.12
10	40	67	8x20	50	307.100.11	307.100.12
12	40	67	8x20	10	307.120.11	307.120.12

TECHNICAL DETAILS:

- Super-strength steel.
- Cutter portion coated with black or orange P.T.F.E.
- HW head with precision balanced centre point.
- 2 HW precision ground cutting edges [Z2].
- Negatively ground spurs [V2].
- 4 spiral flutes.
- Parallel shank with driving flat and length adjusting screw.

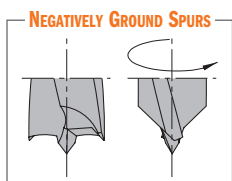
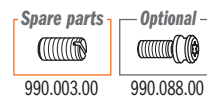

APPLICATION:

used on boring machines equipped with adapters or chucks.
Used to drill blind holes in solid wood, wood composites, plastic and laminated materials.

4 Flute Dowel Drills

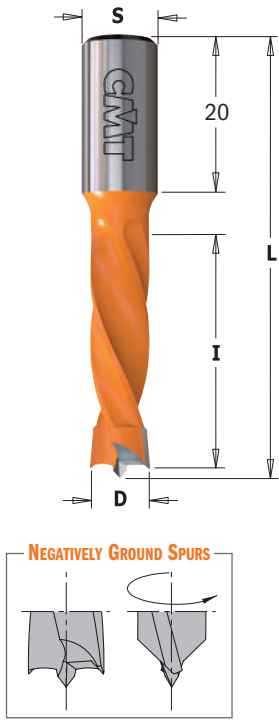

308

HW Z2 V2 RH LH

D mm	I mm	L mm	S mm		ORDER NO. Right-hand rotation	ORDER NO. Left-hand rotation
4	26	57,5	10x20	50	308.040.11	308.040.12
5	30	57,5	10x20	50	308.050.11	308.050.12
6	30	57,5	10x20	50	308.060.11	308.060.12
6,35	30	57,5	10x20	50	308.064.11	308.064.12
7	30	57,5	10x20	50	308.070.11	308.070.12
8	30	57,5	10x20	50	308.080.11	308.080.12
9	30	57,5	10x20	50	308.090.11	308.090.12
9,52	30	57,5	10x20	50	308.095.11	308.095.12
10	30	57,5	10x20	50	308.100.11	308.100.12
11	30	57,5	10x20	10	308.110.11	308.110.12
12	30	57,5	10x20	10	308.120.11	308.120.12
12,7	30	57,5	10x20	10	308.127.11	308.127.12
13	30	57,5	10x20	10	308.130.11	308.130.12
14	30	57,5	10x20	10	308.140.11	308.140.12
15	30	57,5	10x20	10	308.150.11	308.150.12
16	30	57,5	10x20	10	308.160.11	308.160.12

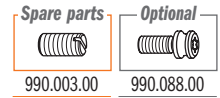

4 Flute Dowel Drills

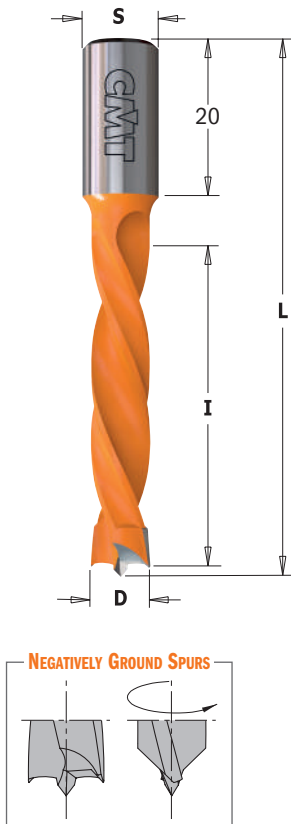

309

HW Z2 V2 RH LH

D mm	I mm	L mm	S mm		ORDER NO. Right-hand rotation	ORDER NO. Left-hand rotation
4	43	70	10x20	50	309.040.11	309.040.12
5	43	70	10x20	50	309.050.11	309.050.12
6	43	70	10x20	50	309.060.11	309.060.12
6,35	43	70	10x20	50	309.064.11	309.064.12
7	43	70	10x20	50	309.070.11	309.070.12
7,5	43	70	10x20	50	309.075.11	309.075.12
8	43	70	10x20	50	309.080.11	309.080.12
9	43	70	10x20	50	309.090.11	309.090.12
9,52	43	70	10x20	50	309.095.11	309.095.12
10	43	70	10x20	50	309.100.11	309.100.12
11	43	70	10x20	10	309.110.11	309.110.12
12	43	70	10x20	10	309.120.11	309.120.12
12,7	43	70	10x20	10	309.127.11	309.127.12
13	43	70	10x20	10	309.130.11	309.130.12
14	43	70	10x20	10	309.140.11	309.140.12
15	43	70	10x20	10	309.150.11	309.150.12
16	43	70	10x20	10	309.160.11	309.160.12

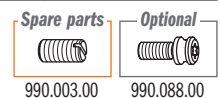

TECHNICAL DETAILS:

- Super-strength steel.
- Cutter portion coated with black or orange PT.FE.
- HW head with precision balanced centre point.
- 2 HW precision ground cutting edges [Z2].
- Negatively ground spurs [V2].
- 4 spiral flutes.
- Parallel shank with driving flat and length adjusting screw.

APPLICATION:

used on boring machines equipped with adapters or chucks.
Used to drill blind holes in solid wood, wood composites, plastic and laminated materials.

4 Flute Dowel Drills

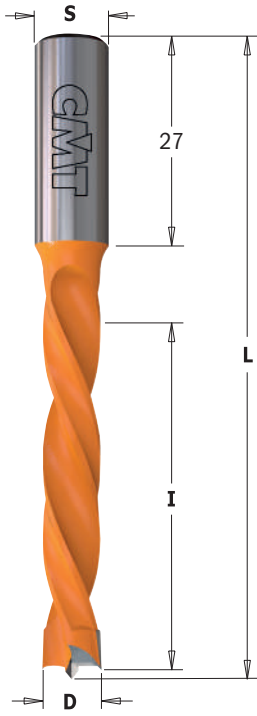

373

HW **Z2** **V2** **RH** **LH**

D mm	I mm	L mm	S mm		ORDER NO. Right-hand rotation	ORDER NO. Left-hand rotation
5	50	85	10x27	50	373.050.11	373.050.12
6	50	85	10x27	50	373.060.11	373.060.12
7	50	85	10x27	50	373.070.11	373.070.12
8	50	85	10x27	50	373.080.11	373.080.12
10	50	85	10x27	50	373.100.11	373.100.12
12	50	85	10x27	10	373.120.11	373.120.12

TECHNICAL DETAILS:

- Super-strength steel.
- Cutter portion coated with black or orange P.T.F.E.
- HW head with precision balanced centre point.
- 2 HW precision ground cutting edges [Z2].
- Negatively ground spurs [V2].
- 4 spiral flutes.
- Parallel shank with driving flat and length adjusting screw.

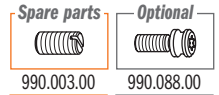

APPLICATION:

used on boring machines equipped with adapters or chucks.
Used to drill blind holes in solid wood, wood composites, plastic and laminated materials.

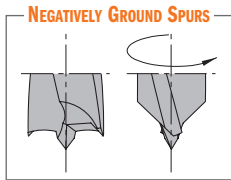

4 Flute Dowel Drills

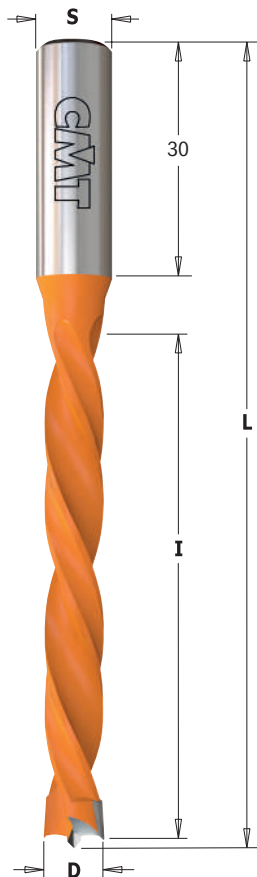

372

HW **Z2** **V2** **RH** **LH**

D mm	I mm	L mm	S mm		ORDER NO. Right-hand rotation	ORDER NO. Left-hand rotation
5	65	105	10x30	10	372.050.11	372.050.12
6	65	105	10x30	10	372.060.11	372.060.12
7	65	105	10x30	10	372.070.11	372.070.12
8	65	105	10x30	10	372.080.11	372.080.12
10	65	105	10x30	10	372.100.11	372.100.12
12	65	105	10x30	10	372.120.11	372.120.12

TECHNICAL DETAILS:

- Super-strength steel.
- Cutter portion coated with black or orange P.T.F.E.
- HW head with precision balanced centre point.
- 2 HW precision ground cutting edges [Z2].
- Negatively ground spurs [V2].
- 4 spiral flutes.
- Parallel shank with driving flat and length adjusting screw.

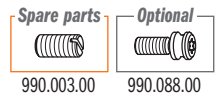

APPLICATION:

used on boring machines equipped with adapters or chucks.
Used to drill blind holes in solid wood, wood composites, plastic and laminated materials.

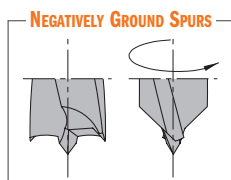

Dowel Drills with Countersink

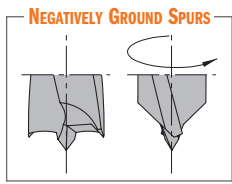
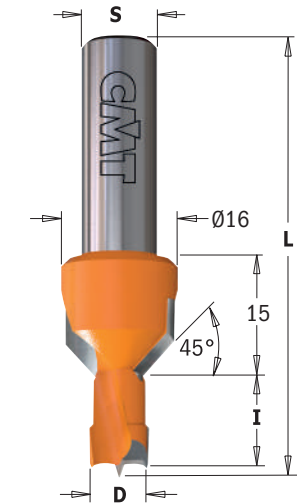

376-377



D mm	I mm	L mm	S mm		ORDER NO. Right-hand rotation	ORDER NO. Left-hand rotation
8	12	57,5	10	10	376.080.11	376.080.12
8	13	57,5	10	10	376.083.11	376.083.12
8	15	57,5	10	10	376.081.11	376.081.12
8	20	57,5	10	10	376.082.11	376.082.12
10	12	57,5	10	10	376.100.11	376.100.12
10	13	57,5	10	10	376.103.11	376.103.12
10	15	57,5	10	10	376.101.11	376.101.12
10	20	57,5	10	10	376.102.11	376.102.12
8	12	70	10	10	377.080.11	377.080.12
8	13	70	10	10	377.083.11	377.083.12
8	15	70	10	10	377.081.11	377.081.12
8	20	70	10	10	377.082.11	377.082.12
10	12	70	10	10	377.100.11	377.100.12
10	13	70	10	10	377.103.11	377.103.12
10	15	70	10	10	377.101.11	377.101.12
10	20	70	10	10	377.102.11	377.102.12

TECHNICAL DETAILS:

- Super-strength steel.
- Spiral portion coated with orange or black P.T.F.E.
- HW head with precision balanced centre point.
- 2 precision ground cutting edges [Z2].
- 2 ground spurs [V2].
- 2 spiral flutes.
- Parallel shank with driving flat and length adjusting screw.

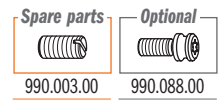

APPLICATION:

used for drilling and countersinking in solid wood, wood composites, plastic and laminated materials. Suitable for high performance speed on boring machines equipped with adapters or chucks.

Dowel Drills for Through Holes with Countersink

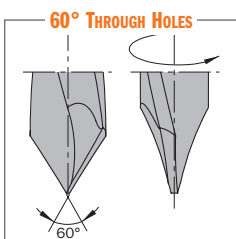
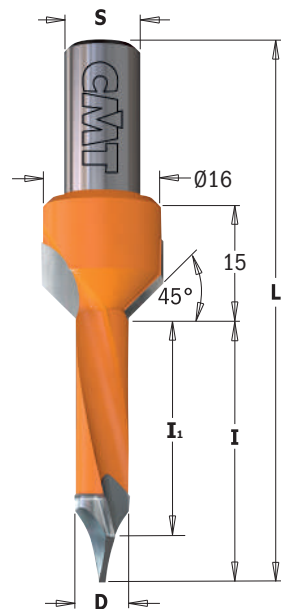

378



D mm	I mm	I ₁ mm	L mm	S mm		ORDER NO. Right-hand rotation	ORDER NO. Left-hand rotation
5	35	31	70	10	10	378.052.11	378.052.12
7	35	29,5	70	10	10	378.072.11	378.072.12
8	35	29	70	10	10	378.082.11	378.082.12
10	35	26,5	70	10	10	378.102.11	378.102.12

TECHNICAL DETAILS:

- Super-strength steel.
- Spiral portion coated with orange or black P.T.F.E.
- HW head with precision balanced centre point.
- 2 precision ground cutting edges [Z2].
- 2 ground spurs [V2].
- 2 spiral flutes.
- Parallel shank with driving flat and length adjusting screw.

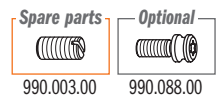

APPLICATION:

used for drilling and countersinking in solid wood, wood composites, plastic and laminated materials. Suitable for high performance speed on boring machines equipped with adapters or chucks.

2 Flute Dowel Drills for Through Holes

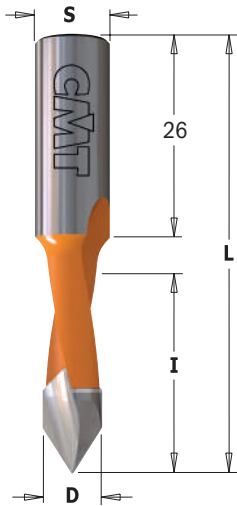

313 For panels with maximum 20mm in thickness

D mm	I mm	L mm	S mm		ORDER NO. Right-hand rotation	ORDER NO. Left-hand rotation
5	27	57,5	10x26	50	313.050.11	313.050.12
6	27	57,5	10x26	50	313.060.11	313.060.12
8	27	57,5	10x26	50	313.080.11	313.080.12
10	27	57,5	10x26	50	313.100.11	313.100.12

TECHNICAL DETAILS:

- Super-strength steel.
- Spiral portion coated with orange or black P.T.F.E.
- HW head with precision balanced centre point.
- 2 precision ground cutting edges [Z2].
- 2 spiral flutes.
- Parallel shank with driving flat and length adjusting screw.

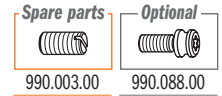

APPLICATION:

used on boring machines and dowel drilling devices.
Use for drilling through holes in solid wood, wood composites, plastic and laminated materials.

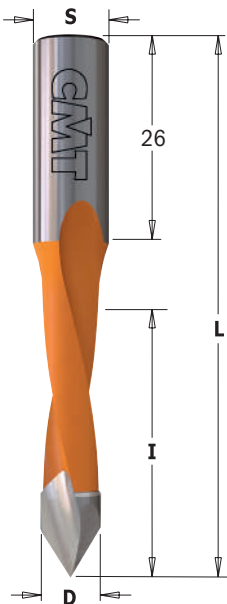
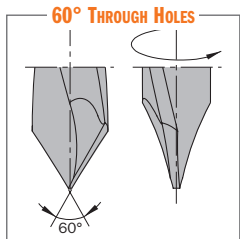

314 For panels with maximum 25-30mm in thickness



D mm	I mm	L mm	S mm		ORDER NO. Right-hand rotation	ORDER NO. Left-hand rotation
4	30	70	10x26	50	314.040.11	314.040.12
4,76	35	70	10x26	50	314.047.11	314.047.12
5	35	70	10x26	50	314.050.11	314.050.12
5,55	35	70	10x26	50	314.055.11	314.055.12
6	35	70	10x26	50	314.060.11	314.060.12
6,35	35	70	10x26	50	314.064.11	314.064.12
7	35	70	10x26	50	314.070.11	314.070.12
8	35	70	10x26	50	314.080.11	314.080.12
9	35	70	10x26	50	314.090.11	314.090.12
9,52	35	70	10x26	50	314.095.11	314.095.12
10	35	70	10x26	50	314.100.11	314.100.12
12	35	70	10x26	10	314.120.11	314.120.12
12,7	35	70	10x26	10	314.127.11	314.127.12

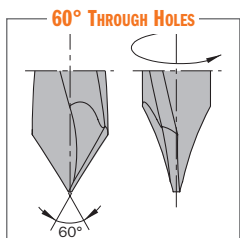

366 For panels with maximum 30-40mm in thickness

D mm	I mm	L mm	S mm		ORDER NO. Right-hand rotation	ORDER NO. Left-hand rotation
5	44	77	10x26	50	366.050.11	366.050.12
6	44	77	10x26	50	366.060.11	366.060.12
8	44	77	10x26	50	366.080.11	366.080.12
10	44	77	10x26	50	366.100.11	366.100.12
12	44	77	10x26	10	366.120.11	366.120.12

TECHNICAL DETAILS:

- Super-strength steel.
- Spiral portion coated with orange or black P.T.F.E.
- HW head with precision balanced centre point.
- 2 precision ground cutting edges [Z2].
- 2 spiral flutes.
- Parallel shank with driving flat and length adjusting screw.

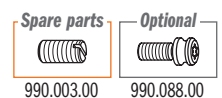

APPLICATION:

used on boring machines and dowel drilling devices.
Use for drilling through holes in solid wood, wood composites, plastic and laminated materials.

4 Flute Dowel Drills for Through Holes

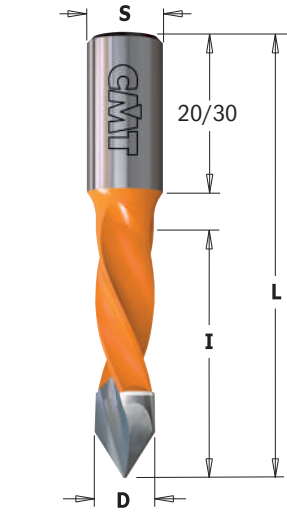

374 For panels with maximum 20-25mm in thickness

D mm	I mm	L mm	S mm		ORDER NO. Right-hand rotation	ORDER NO. Left-hand rotation
5	30	57,5	10x20	50	374.050.11	374.050.12
8	30	57,5	10x20	50	374.080.11	374.080.12

375 For panels with maximum 30-35mm in thickness

D mm	I mm	L mm	S mm		ORDER NO. Right-hand rotation	ORDER NO. Left-hand rotation
4	40	70	10x20	50	375.040.11	375.040.12
5	40	70	10x20	50	375.050.11	375.050.12
6	40	70	10x20	50	375.060.11	375.060.12
7	40	70	10x20	50	375.070.11	375.070.12
8	40	70	10x20	50	375.080.11	375.080.12
9	40	70	10x20	50	375.090.11	375.090.12
10	40	70	10x20	50	375.100.11	375.100.12

381 For panels with maximum 60-65mm in thickness

D mm	I mm	L mm	S mm		ORDER NO. Right-hand rotation	ORDER NO. Left-hand rotation
5	70	115	10x30	10	381.050.11	381.050.12
6	70	115	10x30	10	381.060.11	381.060.12
8	70	115	10x30	10	381.080.11	381.080.12
10	70	115	10x30	10	381.100.11	381.100.12

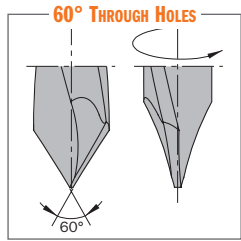

TECHNICAL DETAILS:

- Super-strength steel
- Spiral portion coated with orange or black P.T.F.E.
- HW head with precision balanced centre point
- 2 precision ground cutting edges [Z2] - 4 spiral flutes
- Parallel shank with driving flat and length adjusting screw.

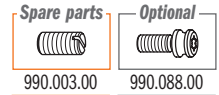

APPLICATION:

used on boring machines and dowel drilling devices.
Use for drilling through holes in solid wood, wood composites, plastic and laminated materials.

2 Flute Dowel Drills for Through Holes

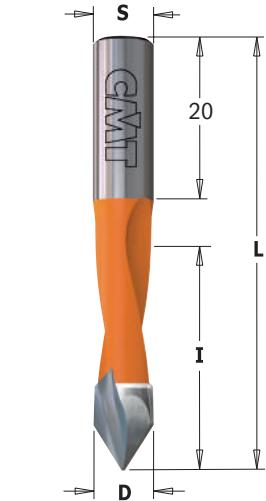

367 For panels with maximum 20-25mm in thickness

D mm	I mm	L mm	S mm		ORDER NO. Right-hand rotation	ORDER NO. Left-hand rotation
5	30	56	8x20	50	367.050.11	367.050.12
8	30	56	8x20	50	367.080.11	367.080.12

368 For panels with maximum 35-40mm in thickness

D mm	I mm	L mm	S mm		ORDER NO. Right-hand rotation	ORDER NO. Left-hand rotation
5	43	70	8x20	50	368.050.11	368.050.12
6	43	70	8x20	50	368.060.11	368.060.12
7	43	70	8x20	50	368.070.11	368.070.12
8	43	70	8x20	50	368.080.11	368.080.12

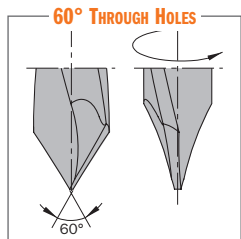

TECHNICAL DETAILS:

- Super-strength steel
- Spiral portion coated with orange or black P.T.F.E.
- HW head with precision balanced centre point
- 2 precision ground cutting edges [Z2]
- 2 spiral flutes
- Parallel shank with driving flat and length adjusting screw.

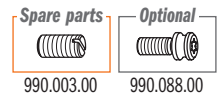

APPLICATION:

used on boring machines and dowel drilling devices.
Use for drilling through holes in solid wood, wood composites, plastic and laminated materials.

Countersinks for 2 Flutes Dowel Drills

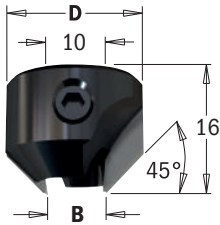

315



B mm	D mm		ORDER NO. Right-hand rotation	ORDER NO. Left-hand rotation
5 ~ 10	20	10	315.200.11	315.200.12
11 ~ 12	22	10	315.220.11	315.220.12

315 ASSEMBLY ILLUSTRATION



TECHNICAL DETAILS:

- Super-strength steel
- 2 precision ground carbide tipped cutting edges [Z2].
- Direct clamp on the shank of the drills.

APPLICATION:

used for chamfering and drilling in solid wood, wood composites, plastic and laminated materials.

Spare parts

990.006.00	991.062.00

Countersinks for 4 Flutes Dowel Drills

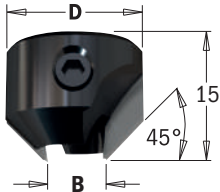

316



B mm	D mm		ORDER NO. Right-hand rotation	ORDER NO. Left-hand rotation
4	16	10	316.040.11	316.040.12
5	16	10	316.050.11	316.050.12
6	16	10	316.060.11	316.060.12
7	16	10	316.070.11	316.070.12
8	18	10	316.080.11	316.080.12
9	18	10	316.090.11	316.090.12
10	20	10	316.100.11	316.100.12
12	20	10	316.120.11	316.120.12

316 ASSEMBLY ILLUSTRATION

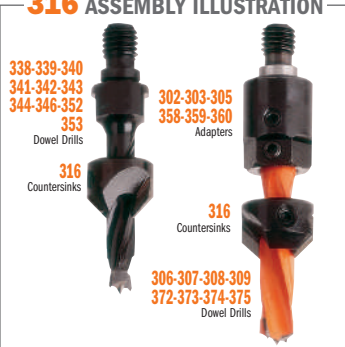

TECHNICAL DETAILS:

- Super-strength steel.
- 2 HW precision ground cutting edges [Z2].

APPLICATION:

used for drilling and chamfering in solid wood, wood composites, plastic and laminated materials.

Spare parts

990.002.00	991.062.00

90° Solid Carbide Countersink

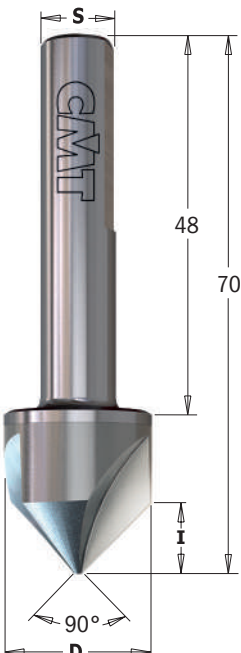

521



D mm	I mm	L mm	S mm		ORDER NO. Right-hand rotation
19,5	9	70	10x48	10	521.002.21

TECHNICAL DETAILS:

- Super strength steel.
- 3 HWM precision ground cutting edges [Z3].
- Parallel shank with driving flat and length adjusting screw.

APPLICATION:

- For making 90° countersink blind holes accepting flat-head fasteners that sit flush with the surface.
- Suitable for wood, wood-based, non-ferrous materials and metal.

Spare parts

990.003.00

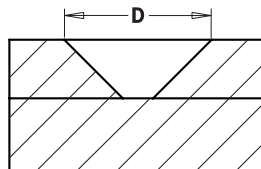

LINE	XTREME DIAMOND	XTREME FLAT	INDUSTRIAL with chipbreaker	INDUSTRIAL
PERFORMANCE	SUPERIOR ★★★★★	SUPERIOR ★★★★★	EXCELLENT ★★★	VERY GOOD ★★★
BIT				
DESCRIPTION	Designed for heavy duty drilling in Large-Scale Industrial Manufacturing ensuring high impact resistance, greater durability and good chip evacuation thanks to the chipbreaker.	Designed for heavy duty drilling in Large-Scale Industrial Manufacturing ensuring high impact resistance and greater durability.	Designed for medium to light-duty drilling in medium to small-scale industrial manufacturing ensuring good chip evacuation thanks to the chipbreaker.	Designed for medium to light-duty drilling in medium to small-scale industrial manufacturing ensuring rigorous impact resistance and good durability.
USER	LARGE-SCALE INDUSTRIAL MANUFACTURING	LARGE-SCALE INDUSTRIAL MANUFACTURING	MEDIUM TO SMALL-SCALE INDUSTRIAL MANUFACTURING	MEDIUM TO SMALL-SCALE INDUSTRIAL MANUFACTURING
RECOMMENDED USE	INDUSTRIAL PRODUCTION	INDUSTRIAL PRODUCTION	INDUSTRIAL/REMODELER	INDUSTRIAL/REMODELER
MATERIALS	Ideal for chipboard, MDF, HDF, laminates and abrasive panels in which long service life is imperative.	Ideal for chipboard, MDF, HDF and laminates. Non-protruding center-point and spurs make this tool perfect for low-thickness panels.	Excellent for solid wood. Good for chipboard, MDF, HDF and laminates.	Excellent for solid wood. Good for chipboard, MDF, HDF and laminates.
SHARPENING & MAINTENANCE	NEGATIVELY GROUND SPURS: standard design HW head featuring precision balanced centre point. 2 HW precision ground cutting edges and 2 negatively ground spurs.	XTREME FLAT SHARPENING: flat edges with reinforced spurs allow perfect finishing and prolonged drilling at high-speed cutting feed.	NEGATIVELY GROUND SPURS: standard design HW head featuring precision balanced centre point. 2 HW precision ground cutting edges with chipbreaker and 2 negatively ground spurs.	NEGATIVELY GROUND SPURS: standard design HW head featuring precision balanced centre point. 2 HW precision ground cutting edges with chipbreaker and 2 negatively ground spurs.
DIAMOND / CARBIDE	The special polycrystalline diamond formula increases tool life up to 20 times longer than HW hinge bits. Good number of resharpenings guaranteed. The best quality/price ratio	INDUSTRIAL CHROMIUM MICROGRAIN CARBIDE Special chromium enhanced carbide produces clean bores with no rough edges even in corners. Chromium Micrograin Carbide guarantees exceptional resistance to fatigue and abrasion for longer lifetime.	INDUSTRIAL GRADE CARBIDE Fine and medium grain carbide grade guarantee reliable prolonged use.	INDUSTRIAL GRADE CARBIDE Fine and medium grain carbide grade guarantee reliable prolonged use.
COATING	High-quality nickel-plated with anti-friction and anti-corrosion properties.	C.M.T. P.T.F.E. coating provides a non-stick surface preventing resin, glue or sludge residue accumulation on the bit body. Baked at 420°, this unique industrial material is specifically designed to fit woodworking tool requirements.	C.M.T. P.T.F.E. coating provides a non-stick surface preventing resin, glue or sludge residue accumulation on the bit body. Baked at 420°, this unique industrial material is specifically designed to fit woodworking tool requirements.	C.M.T. P.T.F.E. coating provides a non-stick surface preventing resin, glue or sludge residue accumulation on the bit body. Baked at 420°, this unique industrial material is specifically designed to fit woodworking tool requirements.
PRICE RANGE	HIGH	MEDIUM/HIGH	MEDIUM	MEDIUM

DP - Hinge Boring Bits

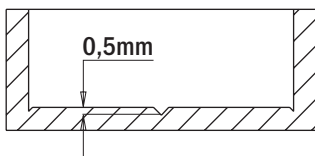
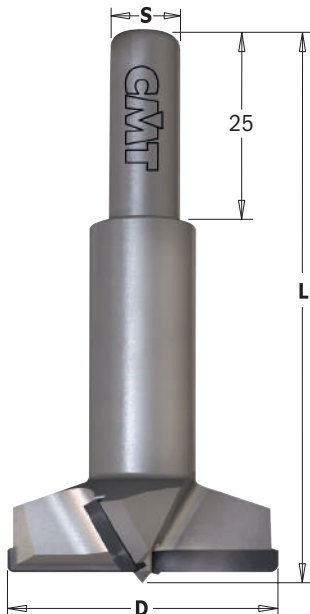

317-369

D mm	L mm	S mm		ORDER NO. Right-hand rotation	ORDER NO. Left-hand rotation
15	57,5	10x25	10	317.150.61	317.150.62
35	57,5	10x25	10	317.350.61	317.350.62
15	70	10x25	10	369.150.61	369.150.62
16	70	10x25	10	369.160.61	369.160.62
20	70	10x25	10	369.200.61	369.200.62
25	70	10x25	10	369.250.61	369.250.62
26	70	10x25	10	369.260.61	369.260.62
35	70	10x25	10	369.350.61	369.350.62

TECHNICAL DETAILS:

- Super-strength steel
- DP head with precision balanced centre point
- 2 DP precision ground cutting edges [Z2].
- 2 DP negatively ground spurs [V2].
- Parallel shank with driving flat and length adjusting screw.

Spare parts 990.003.00
Optional 990.088.00

APPLICATION:

ideal for hinges. Use on boring machines equipped with adapters or chucks. Use for drilling accurate and clean-cut blind holes in wood composites, plastic and laminated materials. Boring performance 20 times longer than HW materials.

REMARK: special dimensions available on request.

New construction with 0,5mm centre point

Hinge Boring Bits

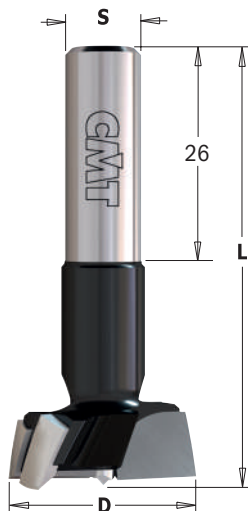

Xtreme Sharpening Curved Spurs

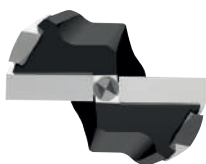

New construction with 0,8mm centre point

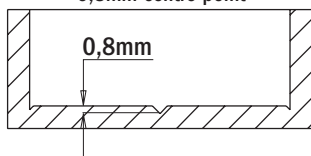

317 XTREME



D mm	L mm	S mm		ORDER NO. Right-hand rotation	ORDER NO. Left-hand rotation
15	57,5	10x26	10	317.150.41	317.150.42
18	57,5	10x26	10	317.180.41	317.180.42
20	57,5	10x26	10	317.200.41	317.200.42
25	57,5	10x26	10	317.250.41	317.250.42
26	57,5	10x26	10	317.260.41	317.260.42
35*	57,5	10x26	10	317.350.41	317.350.42

369 XTREME



D mm	L mm	S mm		ORDER NO. Right-hand rotation	ORDER NO. Left-hand rotation
15	70	10x26	10	369.150.41	369.150.42
18	70	10x26	10	369.180.41	369.180.42
20	70	10x26	10	369.200.41	369.200.42
25	70	10x26	10	369.250.41	369.250.42
26	70	10x26	10	369.260.41	369.260.42
35*	70	10x26	10	369.350.41	369.350.42

*with chipbreaker

TECHNICAL DETAILS:

- Super-strength steel.
- Cutter portion coated with orange or black P.T.F.E.
- HW head with precision balanced centre point.
- 2 HW precision ground cutting edges [Z2].
- 2 negatively ground spurs [V2].
- Parallel shank with driving flat and length adjusting screw.

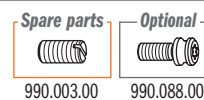

APPLICATION:

ideal for hinges. Use on boring machines equipped with adapters or chucks. Use for drilling accurate and clean-cut blind holes in solid wood, wood composites, plastic and laminated materials.

Hinge Boring Bits with Chipbreaker

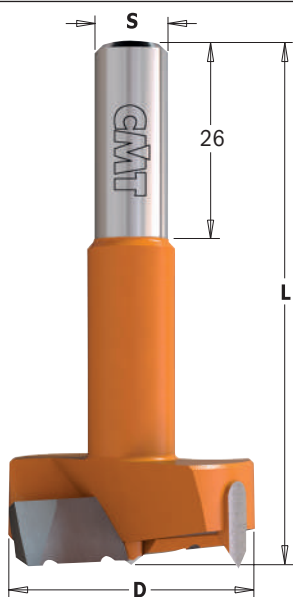

317C - 369C



D mm	L mm	S mm		ORDER NO. Right-hand rotation	ORDER NO. Left-hand rotation
35	57,5	10x26	10	317.350.11C	317.350.12C
40	57,5	10x26	10	317.400.11C	317.400.12C
45	57,5	10x26	10	317.450.11C	317.450.12C
35	70	10x26	10	369.350.11C	369.350.12C
40	70	10x26	10	369.400.11C	369.400.12C
45	70	10x26	10	369.450.11C	369.450.12C

TECHNICAL DETAILS:

- Super-strength steel.
- Cutter portion coated with orange or black P.T.F.E.
- HW head with precision balanced centre point.
- 2 HW precision ground cutting edges with chipbreaker [Z2R].
- 2 negatively ground spurs [V2].
- Parallel shank with driving flat and length adjusting screw.

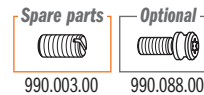

APPLICATION:

ideal for hinges. Used on boring machines equipped with adapters or chucks. For drilling accurate and clean-cut blind holes in solid wood.

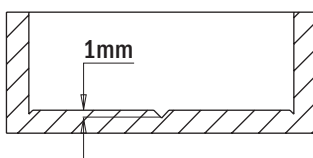

New construction with 1mm centre point

HW Z2 V2 RH LH

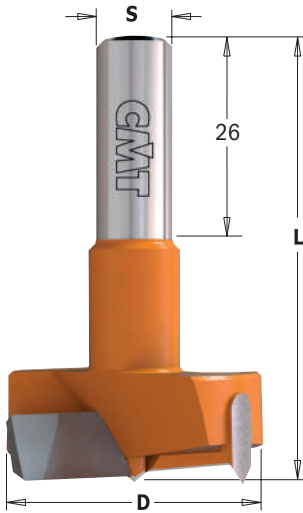

New construction with 1mm centre point

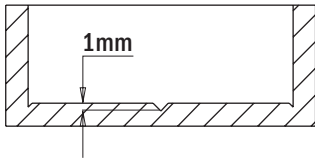

317

D mm	L mm	S mm		ORDER NO. Right-hand rotation	ORDER NO. Left-hand rotation
14	57,5	10x26	10	317.140.11	317.140.12
15	57,5	10x26	10	317.150.11	317.150.12
16	57,5	10x26	10	317.160.11	317.160.12
17	57,5	10x26	10	317.170.11	317.170.12
18	57,5	10x26	10	317.180.11	317.180.12
19	57,5	10x26	10	317.190.11	317.190.12
20	57,5	10x26	10	317.200.11	317.200.12
22	57,5	10x26	10	317.220.11	317.220.12
24	57,5	10x26	10	317.240.11	317.240.12
25	57,5	10x26	10	317.250.11	317.250.12
26	57,5	10x26	10	317.260.11	317.260.12
28	57,5	10x26	10	317.280.11	317.280.12
30	57,5	10x26	10	317.300.11	317.300.12
32	57,5	10x26	10	317.320.11	317.320.12
34	57,5	10x26	10	317.340.11	317.340.12
35	57,5	10x26	10	317.350.11	317.350.12
38	57,5	10x26	10	317.380.11	317.380.12
40	57,5	10x26	10	317.400.11	317.400.12
42	57,5	10x26	10	317.420.11	317.420.12
45	57,5	10x26	10	317.450.11	317.450.12
50	57,5	10x26	10	317.500.11	317.500.12
55	57,5	10x26	10	317.550.11	317.550.12
60	57,5	10x26	10	317.600.11	317.600.12

TECHNICAL DETAILS:

- Super-strength steel.
- Cutter portion coated with orange or black P.T.F.E.
- HW head with precision balanced centre point.
- 2 HW precision ground cutting edges [Z2].
- 2 negatively ground spurs [V2].
- Parallel shank with driving flat and length adjusting screw.

APPLICATION:

ideal for hinges. Use on boring machines equipped with adapters or chucks. Use for drilling accurate and clean-cut blind holes in solid wood, wood composites, plastic and laminated materials.

369

HW Z2 V2 RH LH

D mm	L mm	S mm		ORDER NO. Right-hand rotation	ORDER NO. Left-hand rotation
14	70	10x26	10	369.140.11	369.140.12
15	70	10x26	10	369.150.11	369.150.12
16	70	10x26	10	369.160.11	369.160.12
18	70	10x26	10	369.180.11	369.180.12
20	70	10x26	10	369.200.11	369.200.12
22	70	10x26	10	369.220.11	369.220.12
25	70	10x26	10	369.250.11	369.250.12
26	70	10x26	10	369.260.11	369.260.12
30	70	10x26	10	369.300.11	369.300.12
35	70	10x26	10	369.350.11	369.350.12
40	70	10x26	10	369.400.11	369.400.12
45	70	10x26	10	369.450.11	369.450.12
50	70	10x26	10	369.500.11	369.500.12
55	70	10x26	10	369.550.11	369.550.12
60	70	10x26	10	369.600.11	369.600.12

370

HW Z2 V2 RH LH

D mm	L mm	S mm		ORDER NO. Right-hand rotation	ORDER NO. Left-hand rotation
18	77	10x30	10	370.180.11	370.180.12
20	77	10x30	10	370.200.11	370.200.12
25	77	10x30	10	370.250.11	370.250.12
30	77	10x30	10	370.300.11	370.300.12
35	77	10x30	10	370.350.11	370.350.12

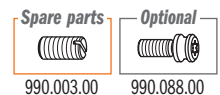

HW **Z2** **V2** **RH** **LH**

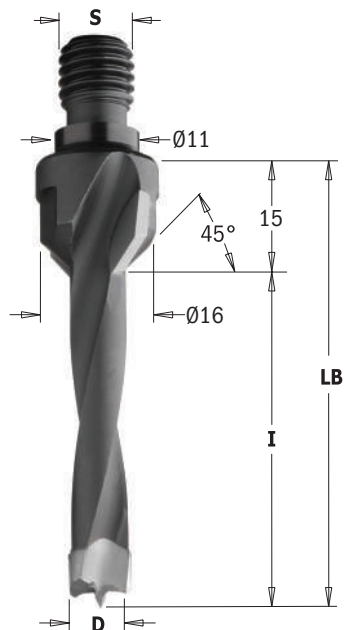

325-327-329-330

D mm	I mm	LB mm	S mm		ORDER NO. Right-hand rotation	ORDER NO. Left-hand rotation
5	20	35	M10/11x4	10	325.050.11	325.050.12
6	20	35	M10/11x4	10	325.060.11	325.060.12
8	20	35	M10/11x4	10	325.080.11	325.080.12
10	20	35	M10/11x4	10	325.100.11	325.100.12
12	20	35	M10/11x4	10	325.120.11	325.120.12
5	30	45	M10/11x4	10	327.050.11	327.050.12
6	30	45	M10/11x4	10	327.060.11	327.060.12
8	30	45	M10/11x4	10	327.080.11	327.080.12
10	30	45	M10/11x4	10	327.100.11	327.100.12
12	30	45	M10/11x4	10	327.120.11	327.120.12
5	40	55	M10/11x4	10	329.050.11	329.050.12
6	40	55	M10/11x4	10	329.060.11	329.060.12
8	40	55	M10/11x4	10	329.080.11	329.080.12
10	40	55	M10/11x4	10	329.100.11	329.100.12
12	40	55	M10/11x4	10	329.120.11	329.120.12
5	50	65	M10/11x4	10	330.050.11	330.050.12
6	50	65	M10/11x4	10	330.060.11	330.060.12
8	50	65	M10/11x4	10	330.080.11	330.080.12
10	50	65	M10/11x4	10	330.100.11	330.100.12
12	50	65	M10/11x4	10	330.120.11	330.120.12

TECHNICAL DETAILS:

- Super-strength steel.
- HW head with precision balanced centre point.
- 2 precision ground cutting edges [Z2].
- 2 spiral flutes.
- 2 ground spurs [V2].

APPLICATION:

used on boring machines equipped with chucks. Used to drill blind holes in solid wood, wood composites, plastic and laminated materials.

Dowel Drills with Threaded Shank without Countersink



338-339-340

HW **Z2** **V2** **RH** **LH**

D mm	I mm	LB mm	S mm		ORDER NO. Right-hand rotation	ORDER NO. Left-hand rotation
5	30	45	M10/11x4	10	338.050.11	338.050.12
6	30	45	M10/11x4	10	338.060.11	338.060.12
8	30	45	M10/11x4	10	338.080.11	338.080.12
10	30	45	M10/11x4	10	338.100.11	338.100.12
12	30	45	M10/11x4	10	338.120.11	338.120.12
5	40	55	M10/11x4	10	339.050.11	339.050.12
6	40	55	M10/11x4	10	339.060.11	339.060.12
8	40	55	M10/11x4	10	339.080.11	339.080.12
10	40	55	M10/11x4	10	339.100.11	339.100.12
12	40	55	M10/11x4	10	339.120.11	339.120.12
5	50	65	M10/11x4	10	340.050.11	340.050.12
6	50	65	M10/11x4	10	340.060.11	340.060.12
8	50	65	M10/11x4	10	340.080.11	340.080.12
10	50	65	M10/11x4	10	340.100.11	340.100.12
12	50	65	M10/11x4	10	340.120.11	340.120.12

TECHNICAL DETAILS:

- Super-strength steel.
- HW head with precision balanced centre point.
- 2 precision ground cutting edges [Z2].
- 2 ground spurs [V2].
- 4 spiral flutes.

APPLICATION:

used on boring machines equipped with chucks. Used to drill blind holes in solid wood, wood composites, plastic and laminated materials.

Dowel Drills with Threaded Shank



344



D mm	I mm	LB mm	S mm		ORDER NO. Right-hand rotation	ORDER NO. Left-hand rotation
5	43	63	M8	10	344.050.11	344.050.12
6	43	63	M8	10	344.060.11	344.060.12
8	43	63	M8	10	344.080.11	344.080.12
10	43	63	M8	10	344.100.11	344.100.12
12	43	63	M8	10	344.120.11	344.120.12

FOR USE ON THE FOLLOWING MACHINES:
NOTTMEYER® (older models)

346



D mm	I mm	LB mm	S mm		ORDER NO. Right-hand rotation	ORDER NO. Left-hand rotation
5	43	63	M10	10	346.050.11	346.050.12
6	43	63	M10	10	346.060.11	346.060.12
8	43	63	M10	10	346.080.11	346.080.12
10	43	63	M10	10	346.100.11	346.100.12
12	43	63	M10	10	346.120.11	346.120.12

FOR USE ON THE FOLLOWING MACHINES:

AYEN®, HOLZMA®, KNOEVENAGEL®, MAYER®, TORWEGGE®.

TECHNICAL DETAILS:

- Super-strength steel.
- HW head with precision balanced centre point.
- 2 precision ground cutting edges [Z2].
- 2 ground spurs [V2].
- 4 spiral flutes.

APPLICATION:

used on boring machines equipped with chucks.
Used to drill blind holes in solid wood, wood composites, plastic and laminated materials.

Dowel Drills with Threaded Shank



352-353



D mm	I mm	LB mm	S mm		ORDER NO. Right-hand rotation	ORDER NO. Left-hand rotation
5	30	45	M8/9	10	352.050.11	352.050.12
6	30	45	M8/9	10	352.060.11	352.060.12
8	30	45	M8/9	10	352.080.11	352.080.12
10	30	45	M8/9	10	352.100.11	352.100.12
12	30	45	M8/9	10	352.120.11	352.120.12
5	40	55	M8/9	10	353.050.11	353.050.12
6	40	55	M8/9	10	353.060.11	353.060.12
8	40	55	M8/9	10	353.080.11	353.080.12
10	40	55	M8/9	10	353.100.11	353.100.12
12	40	55	M8/9	10	353.120.11	353.120.12

FOR USE ON THE FOLLOWING MACHINES:

MASTERWOOD® (Zangheri & Boschetti)
MORBIDELLI®, NOTTMEYER® (new design)

TECHNICAL DETAILS:

- Super-strength steel.
- HW head with precision balanced centre point.
- 2 precision ground cutting edges [Z2].
- 2 ground spurs [V2].
- 4 spiral flutes.

APPLICATION:

used on boring machines equipped with chucks.
Used to drill blind holes in solid wood, wood composites, plastic and laminated materials.

HW **Z2** **V2** **RH** **LH**

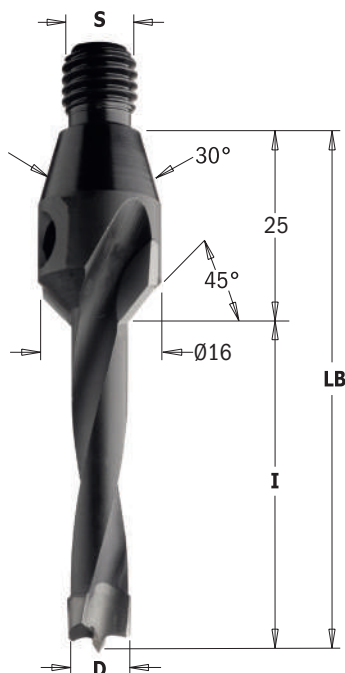

332-334-336-337

D mm	I mm	LB mm	S mm		ORDER NO. Right-hand rotation	ORDER NO. Left-hand rotation
<input type="checkbox"/> 5	20	45	M10/30°	10	332.050.11	332.050.12
<input type="checkbox"/> 6	20	45	M10/30°	10	332.060.11	332.060.12
<input type="checkbox"/> 8	20	45	M10/30°	10	332.080.11	332.080.12
<input type="checkbox"/> 10	20	45	M10/30°	10	332.100.11	332.100.12
<input type="checkbox"/> 12	20	45	M10/30°	10	332.120.11	332.120.12
<input type="checkbox"/> 5	30	55	M10/30°	10	334.050.11	334.050.12
<input type="checkbox"/> 6	30	55	M10/30°	10	334.060.11	334.060.12
<input type="checkbox"/> 8	30	55	M10/30°	10	334.080.11	334.080.12
<input type="checkbox"/> 10	30	55	M10/30°	10	334.100.11	334.100.12
<input type="checkbox"/> 12	30	55	M10/30°	10	334.120.11	334.120.12
<input type="checkbox"/> 5	40	65	M10/30°	10	336.050.11	336.050.12
<input type="checkbox"/> 6	40	65	M10/30°	10	336.060.11	336.060.12
<input type="checkbox"/> 8	40	65	M10/30°	10	336.080.11	336.080.12
<input type="checkbox"/> 10	40	65	M10/30°	10	336.100.11	336.100.12
<input type="checkbox"/> 12	40	65	M10/30°	10	336.120.11	336.120.12
<input type="checkbox"/> 5	50	75	M10/30°	10	337.050.11	337.050.12
<input type="checkbox"/> 6	50	75	M10/30°	10	337.060.11	337.060.12
<input type="checkbox"/> 8	50	75	M10/30°	10	337.080.11	337.080.12
<input type="checkbox"/> 10	50	75	M10/30°	10	337.100.11	337.100.12
<input type="checkbox"/> 12	50	75	M10/30°	10	337.120.11	337.120.12

On request

TECHNICAL DETAILS:

- Super-strength steel.
- HW head with precision balanced centre point.
- 2 precision ground cutting edge [Z2].
- 2 ground spurts [V2].
- 2 spiral flutes.

APPLICATION:

used on boring machines equipped with chucks. Used to drill blind holes in solid wood, wood composites, plastic and laminated materials.

Dowel Drills with Threaded Shank without Countersink

HW **Z2** **V2** **RH** **LH**



341-342-343

D mm	I mm	LB mm	S mm		ORDER NO. Right-hand rotation	ORDER NO. Left-hand rotation
<input type="checkbox"/> 5	30	55	M10/30°	10	341.050.11	341.050.12
<input type="checkbox"/> 6	30	55	M10/30°	10	341.060.11	341.060.12
<input type="checkbox"/> 8	30	55	M10/30°	10	341.080.11	341.080.12
<input type="checkbox"/> 10	30	55	M10/30°	10	341.100.11	341.100.12
<input type="checkbox"/> 12	30	55	M10/30°	10	341.120.11	341.120.12
<input type="checkbox"/> 5	40	65	M10/30°	10	342.050.11	342.050.12
<input type="checkbox"/> 6	40	65	M10/30°	10	342.060.11	342.060.12
<input type="checkbox"/> 8	40	65	M10/30°	10	342.080.11	342.080.12
<input type="checkbox"/> 10	40	65	M10/30°	10	342.100.11	342.100.12
<input type="checkbox"/> 12	40	65	M10/30°	10	342.120.11	342.120.12
<input type="checkbox"/> 5	50	75	M10/30°	10	343.050.11	343.050.12
<input type="checkbox"/> 6	50	75	M10/30°	10	343.060.11	343.060.12
<input type="checkbox"/> 8	50	75	M10/30°	10	343.080.11	343.080.12
<input type="checkbox"/> 10	50	75	M10/30°	10	343.100.11	343.100.12
<input type="checkbox"/> 12	50	75	M10/30°	20	343.120.11	343.120.12

On request

TECHNICAL DETAILS:

- Super-strength steel.
- HW head with precision balanced centre point.
- 2 precision ground cutting edges [Z2].
- 2 ground spurs [V2].
- 4 spiral flutes.

APPLICATION:

used on boring machines equipped with chucks. Used to drill blind holes in solid wood, wood composites, plastic and laminated materials.

BITS FOR HAND POWER TOOLS

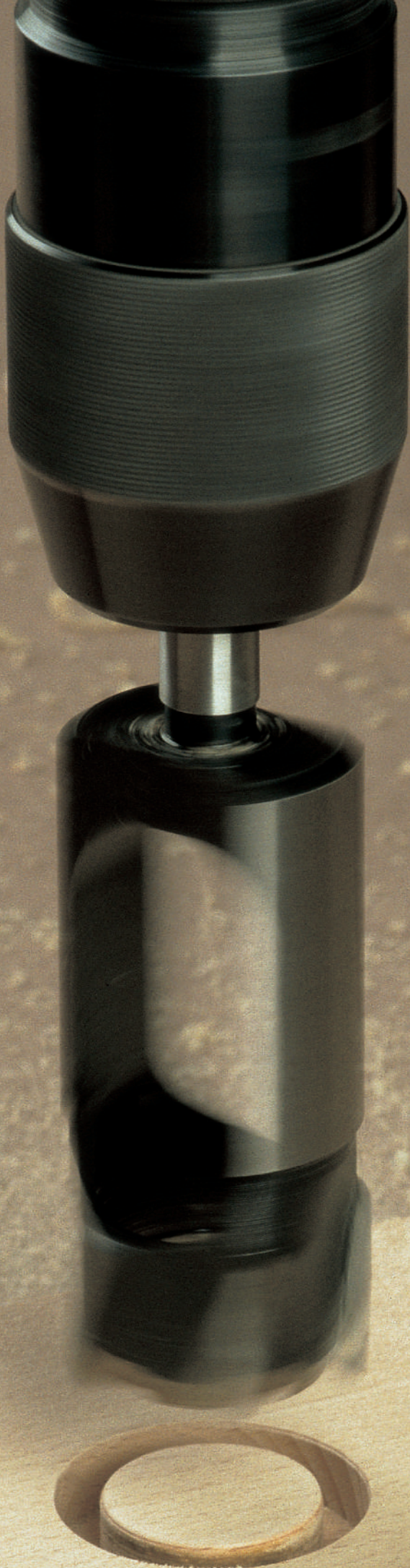

PRODUCTS	PAGE
Adapters & Extension	344-345
Interchangeable Boring Bits	345
Boring Bits	346-349
Chisel & Bit Sets	349
Plug Cutters & Sets	350-351
Forstner Bits	352
Rosette Cutters	353
Auger & Brad Point Bits	354
Bits for MAFELL® & FESTOOL® Machines	355
Brad Point Bits & Sets	356-357
Drill Bits for ANUBA® Hinges	357
Countersinks & Drills	358-361



©Brand names mentioned in CMT products are the property of their respective owners (see back cover)

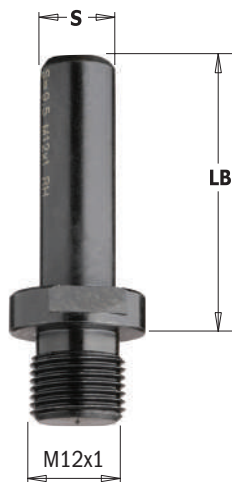

509-532-533 ...with parallel shank for interchangeable bits

RH **LH**

S mm	LB mm			ORDER NO. Right-hand rotation	ORDER NO. Left-hand rotation
8x30	35		10	532.080.01	
9,5x30	35		10	532.095.01	
10x50	60		1	533.100.01	533.100.02
12x30	35		10	532.120.01	
13x50	100		1	509.130.01	509.130.02
16x50	100		1	509.160.01	509.160.02

For use with the following parts: **501** HW

TECHNICAL DETAILS:

- Super strength steel
- Precision grinding on all contact surfaces.

APPLICATION:

for use on boring machines equipped with adapters and/or chucks.

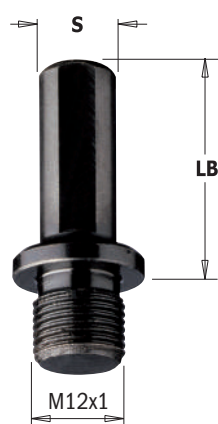

511 ...with parallel shank for quick change drills

RH **LH**

S mm	LB mm		ORDER NO. Right-hand rotation	ORDER NO. Left-hand rotation
10x20 (with driving flat and screw)	27	10	511.270.01	511.270.02
10x35 (with driving flat and screw)	40	10	511.400.01	511.400.02

For use with the following parts: **501** HW

TECHNICAL DETAILS:

- Super strength steel
- Precision grinding on all contact surfaces.

APPLICATION:

for use on boring machines equipped with adapters and/or chucks.

Spare parts



990.003.00



506

RH **LH**

S mm	LB mm		ORDER NO. Right-hand rotation	ORDER NO. Left-hand rotation
M10/11x4	15	1	506.150.01	506.150.02
M10/11x4	25	1	506.250.01	506.250.02
M10/11x4	35	1	506.350.01	506.350.02

For use with the following parts: **501** HW

TECHNICAL DETAILS:

- Super strength steel.
- Precision grinding on all contact surfaces.

APPLICATION:

for use on boring machines equipped with adapters and/or chucks.



503

RH **LH**

S mm	LB mm		ORDER NO. Right-hand rotation	ORDER NO. Left-hand rotation
M10/30°	25	1	503.250.01	503.250.02
M10/30°	35	1	503.350.01	503.350.02
M10/30°	45	1	503.450.01	503.450.02

For use with the following parts: **501** HW

TECHNICAL DETAILS:

- Super strength steel
- Precision grinding on all contact surfaces.

APPLICATION:

for use on boring machines equipped with adapters and/or chucks.



534

S mm				ORDER NO. Right-hand rotation
MK2/Ø20x14F.x1"			1	534.020.01
MK2/M30x1,5			1	534.030.01

For use with the following parts: **501 HW**

TECHNICAL DETAILS:
- Super strength steel.

APPLICATION:
for use on CNC machining centers or hand-held routers equipped with adapters and/or chucks.

Extension for drills with hexagonal shank



507

S	mm	L inches	B mm		ORDER NO.
Hexagonal 1/4"	330	13	8	25	507.080.33
Hexagonal 11/32"	330	13	9,5	25	507.095.33
Hexagonal 11/32"	330	13	10	25	507.100.33

TECHNICAL DETAILS:
- High strength resistant steel
- Precision grinding on all contact surfaces.

Interchangeable Boring Bits with Threaded Shank

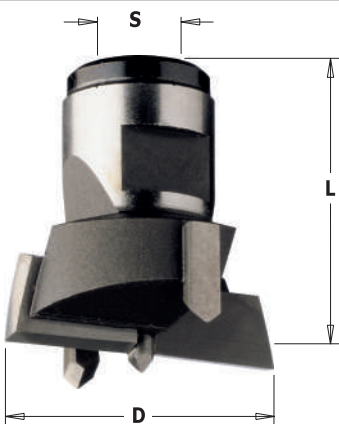

501



D mm	L mm	S mm			ORDER NO. Right-hand rotation	ORDER NO. Left-hand rotation
20	30	M12x1		1	501.200.11	501.200.12
22	30	M12x1		1	501.220.11	501.220.12
24	30	M12x1		1	501.240.11	501.240.12
25	30	M12x1		1	501.250.11	501.250.12
26	30	M12x1		1	501.260.11	501.260.12
30	30	M12x1		1	501.300.11	501.300.12
32	30	M12x1		1	501.320.11	501.320.12
34	30	M12x1		1	501.340.11	501.340.12
35	30	M12x1		1	501.350.11	501.350.12
36	30	M12x1		1	501.360.11	501.360.12
38	30	M12x1		1	501.380.11	501.380.12
40	30	M12x1		1	501.400.11	501.400.12
45	30	M12x1		1	501.450.11	501.450.12
50	30	M12x1		1	501.500.11	501.500.12
55	30	M12x1		1	501.550.11	501.550.12
60	30	M12x1		1	501.600.11	501.600.12

HW **Z2** **V2** **RH**

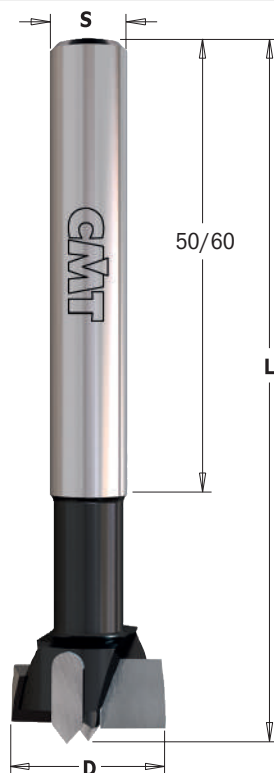

512

D mm	L mm	S mm		ORDER NO. Right-hand rotation
14	90	10x60	10	512.140.11
15	90	10x60	10	512.150.11
16	90	10x60	10	512.160.11
17	90	10x60	10	512.170.11
18	90	10x60	10	512.180.11
19	90	10x60	10	512.190.11
20	90	10x60	10	512.200.11
21	90	10x60	10	512.210.11
22	90	10x60	10	512.220.11
23	90	10x60	10	512.230.11
24	90	10x60	10	512.240.11
25	90	10x60	10	512.250.11
26	90	10x60	10	512.260.11
27	90	10x60	10	512.270.11
28	90	10x60	10	512.280.11
29	90	10x60	10	512.290.11
30	90	10x60	10	512.300.11
31	90	10x60	10	512.310.11
32	90	10x60	10	512.320.11
33	90	10x60	10	512.330.11
34	90	10x60	10	512.340.11
35	90	10x60	10	512.350.11
38	90	10x60	10	512.380.11
40	90	10x60	10	512.400.11
42	90	10x60	10	512.420.11
45	90	10x50	10	512.450.11
48	90	10x50	10	512.480.11
50	90	10x50	10	512.500.11
55	90	10x50	5	512.550.11
58	90	10x50	5	512.580.11
60	90	10x50	5	512.600.11

TECHNICAL DETAILS:

- Super strength steel
- HW precision balanced centre point
- 2 HW precision ground cutting edges [Z2]
- 2 HW negatively ground spurs [V2]
- Parallel shank.

APPLICATION:

for drilling blind holes in solid wood, wood derivatives and laminate materials. **Ideal for hinges.**

5-Piece Boring Bit Set for Hinges

HW **Z2** **V2** **RH**



512.001.01

The perfect set for hinge work and other related applications. Machined from special high speed steel and featuring tungsten carbide tipped cutting edges.

TECHNICAL DETAILS:

- Super strength steel
- HW precision balanced centre point
- 2 HW precision ground cutting edges [Z2]
- 2 HW negatively ground spurs [V2].

APPLICATION:

for drilling blind holes in solid wood, wood derivatives and laminated materials. **Ideal for hinges.**

DESCRIPTION	S mm	L mm	BIT DIAMETER mm		ORDER NO. Right-hand rotation
5-Piece Boring Bit Set for Hinges	10	90	15-20-25-30-35	5	512.001.01

SP Z2 V2 RH

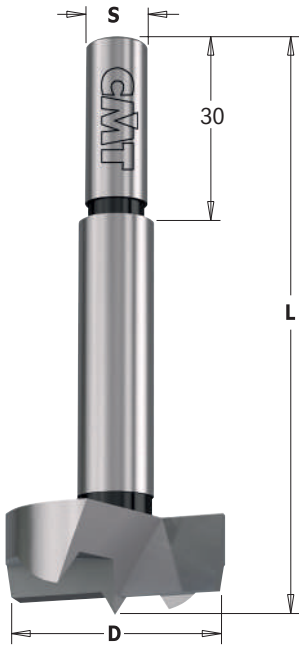

512

D mm	L mm	S mm		ORDER NO. Right-hand rotation
8	90	8x30	10	512.081.31
10	90	8x30	10	512.101.31
12	90	8x30	10	512.121.31
14	90	8x30	10	512.141.31
15	90	8x30	10	512.151.31
16	90	8x30	10	512.161.31
18	90	8x30	10	512.181.31
20	90	8x30	10	512.201.31
22	90	8x30	10	512.221.31
24	90	8x30	10	512.241.31
25	90	8x30	10	512.251.31
26	90	8x30	10	512.261.31
28	90	8x30	10	512.281.31
30	90	8x30	10	512.301.31
32	90	10x30	10	512.321.31
34	90	10x30	10	512.341.31
35	90	10x30	10	512.351.31
38	90	10x30	10	512.381.31
40	90	10x30	10	512.401.31
45	90	10x30	10	512.451.31
50	90	10x30	10	512.501.31

TECHNICAL DETAILS:

- Long-lasting cutting performance
- SP steel
- Precision balanced centre point
- 2 ground spurs [V2]
- 2 precision ground cutting edges [Z2]

APPLICATION:

used for drilling blind holes in solid wood, wood derivatives and laminates. **Ideal for hinges.**

5-Piece Boring Bit Set for Hinges



512.001.00

SP Z2 V2 RH

The perfect hinge work set for the most popular brand applications. Machined from special high speed steel its really does a great job for those traditional hinge jobs.

TECHNICAL DETAILS:

- Long-lasting cutting performance
- SP steel
- Precision balanced centre point
- 2 ground spurs [V2]
- 2 precision ground cutting edges [Z2].

APPLICATION:

for drilling blind holes in solid wood, wood derivatives and laminates. **Ideal for hinges.**

DESCRIPTION	S mm	L mm	BIT DIAMETER mm		ORDER NO. Right-hand rotation
5-Piece Boring Bit Set for Hinges	10	90	15-20-25-30-35	5	512.001.00

HW Z2 V2 RH

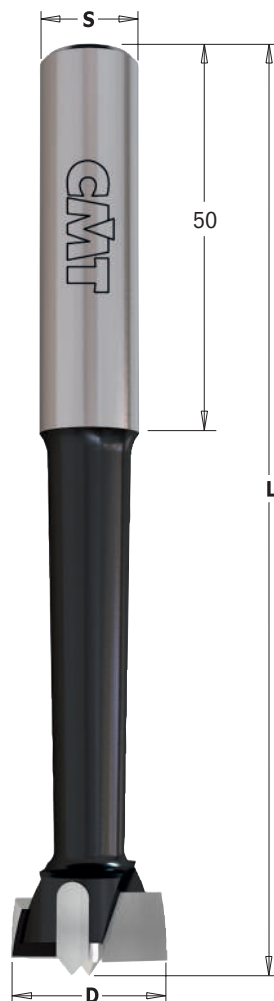

513

D mm	L mm	S mm		ORDER NO. Right-hand rotation
15	120	13	1	513.150.11
16	120	13	1	513.160.11
18	120	13	1	513.180.11
20	120	13	1	513.200.11
22	125	13	1	513.220.11
25	125	13	1	513.250.11
26	125	13	1	513.260.11
28	130	13	1	513.280.11
30	130	13	1	513.300.11
35	130	13	1	513.350.11
40	130	13	1	513.400.11
45	130	13	1	513.450.11
50	130	13	1	513.500.11
55	140	13	1	513.550.11
60	140	13	1	513.600.11

514

D mm	L mm	S mm		ORDER NO. Right-hand rotation
15	120	16	1	514.150.11
16	120	16	1	514.160.11
18	120	16	1	514.180.11
20	120	16	1	514.200.11
22	125	16	1	514.220.11
25	125	16	1	514.250.11
26	125	16	1	514.260.11
28	130	16	1	514.280.11
30	130	16	1	514.300.11
32	130	16	1	514.320.11
35	130	16	1	514.350.11
40	130	16	1	514.400.11
45	130	16	1	514.450.11
50	130	16	1	514.500.11
55	140	16	1	514.550.11
60	140	16	1	514.600.11

TECHNICAL DETAILS:

- Super strength steel
- HW precision balanced centre point
- 2 HW precision ground cutting edges [Z2]
- 2 HW negatively ground spurs [V2].

APPLICATION:

for drilling blind holes in solid wood, wood derivatives and laminates. **Ideal for hinges.**

Boring Bits with Parallel Shank

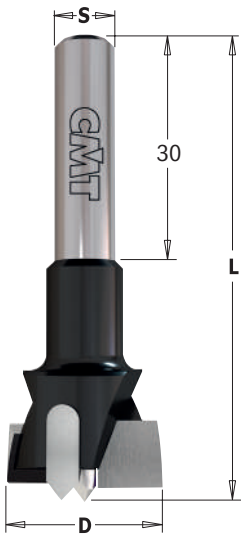

392

HW Z2 V2 RH

D mm	L mm	S mm		ORDER NO. Right-hand rotation
15	60	8	10	392.150.11
20	60	8	10	392.200.11
25	60	8	10	392.250.11
26	60	8	10	392.260.11
30	60	8	10	392.300.11
35	60	8	10	392.350.11
35	60	12,7	10	392.351.11
40	60	8	10	392.400.11

TECHNICAL DETAILS:

- Super strength steel
- HW precision balanced centre point
- 2 HW precision ground cutting edges [Z2]
- 2 HW negatively ground spurs [V2].

APPLICATION:

for drilling blind holes in solid wood, wood derivatives and laminates. **Ideal for hinges.**

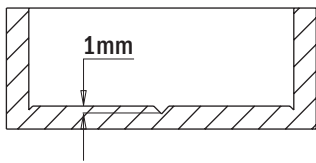

New construction with 1mm centre point

Mortise Chisel & Bit Sets



543

HSS Z1 RH

mm	D	inches	mm	S	inches		ORDER NO. Right-hand rotation
6,35		1/4	19		3/4	1	543.064.51
8		5/16	19		3/4	1	543.079.51
9,5		3/8	19		3/4	1	543.095.51
12,7		1/2	19		3/4	1	543.127.51
15,8		5/8	19		3/4	1	543.158.51
19		3/4	19		3/4	1	543.190.51

It's tough to beat the old faithful mortise and tenon joint for strength and accuracy, even with all the other joinery options in the world of woodworking. It isn't the easiest joint to make, but it surely helps to have the best quality tools in your shop. That's why we've added a new selection of chisel and bit sets in all the popular sizes 6,35mm (1/4") to 19mm (3/4") diameter.

These sets are for use on any standard drill press mortising attachment of mortising machines.



Sample of Chisel Mortiser

SP RH



529

d mm	D mm	L mm	S mm	Z		ORDER NO. Right-hand rotation
8	18	140	13	4	5	529.080.31
10	20	140	13	4	5	529.100.31
12	24	140	13	4	5	529.120.31
14	26	140	13	4	5	529.140.31
15	27	140	13	4	5	529.150.31
16	28	140	13	4	5	529.160.31
18	30	140	13	4	5	529.180.31
20	32	140	13	4	5	529.200.31
22	34	140	13	5	5	529.220.31
25	37	140	13	5	5	529.250.31
30	42	140	13	5	5	529.300.31
32	44	140	13	5	5	529.320.31
35	47	160	16	6	2	529.350.31
40	52	160	16	6	2	529.400.31
45	57	160	16	6	2	529.450.31
50	62	160	16	6	2	529.500.31

d inches	D inches	L inches	S inches	Z		ORDER NO. Right-hand rotation
3/8	49/64	5-1/2	1/2	4	5	529.095.31
1/2	61/64	5-1/2	1/2	4	5	529.127.31
5/8	1-7/64	5-1/2	1/2	4	5	529.158.31
3/4	1-7/32	5-1/2	1/2	4	5	529.191.31
7/8	1-11/32	5-1/2	1/2	4	5	529.222.31
1	1-15/32	5-1/2	1/2	5	5	529.254.31
1-1/4	1-19/32	5-1/2	1/2	5	5	529.317.31
1-3/8	1-27/32	6-5/16	5/8	6	2	529.349.31
1-1/2	1-31/32	6-5/16	5/8	6	2	529.381.31
1-5/8	2-3/32	6-5/16	5/8	6	2	529.413.31
1-3/4	2-7/32	6-5/16	5/8	6	2	529.445.31
2	2-15/32	6-5/16	5/8	6	2	529.508.31

Use our D=16mm bushing to increase the 13mm shank (article no. 799.130.00 on page 426)

TECHNICAL DETAILS:

- SP steel
- Long lasting cutting performance
- 4 cutting edges.

APPLICATION:

for drilling plugs in natural soft or medium-density woods.

D mm	D inches	Max RPM Softwood	Max RPM Hardwood
< Ø16	5/8	1000	500
< Ø40	1-37/64	500	300
> Ø40	1-37/64	200	150

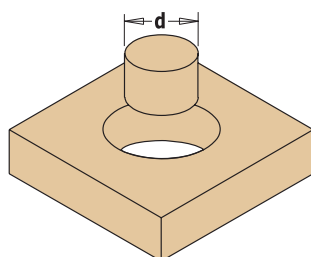

500.001/02/03

SP RH

We offer a wide range of boring bits and plug cutters in the most popular diameters. If you need to drill plugs in soft to medium-density hardwood, you've got three different sets to choose from.



500.001.08 Boring Bit & Plug Cutter Set

SET CONTAINS	D mm	L mm	S mm	ORDER NO. Right-hand rotation
Boring Bit with Parallel Shank	8	90	10	512.081.31
Boring Bit with Parallel Shank	10	90	10	512.101.31
Boring Bit with Parallel Shank	12	90	10	512.121.31
Boring Bit with Parallel Shank	15	90	10	512.151.31
Plug Cutter	8	140	13	529.080.31
Plug Cutter	10	140	13	529.100.31
Plug Cutter	12	140	13	529.120.31
Plug Cutter	15	140	13	529.150.31



500.002.08 Boring Bit & Plug Cutter Set

SET CONTAINS	D mm	L mm	S mm	ORDER NO. Right-hand rotation
Boring Bit with Parallel Shank	16	90	10	512.161.31
Boring Bit with Parallel Shank	20	90	10	512.201.31
Boring Bit with Parallel Shank	25	90	10	512.251.31
Boring Bit with Parallel Shank	30	90	10	512.301.31
Plug Cutter	16	140	13	529.160.31
Plug Cutter	20	140	13	529.200.31
Plug Cutter	25	140	13	529.250.31
Plug Cutter	30	140	13	529.300.31

500.003.08 Boring Bit & Plug Cutter Set

SET CONTAINS	D mm	L mm	S mm	ORDER NO. Right-hand rotation
Boring Bit with Parallel Shank	15	90	10	512.151.31
Boring Bit with Parallel Shank	20	90	10	512.201.31
Boring Bit with Parallel Shank	25	90	10	512.251.31
Boring Bit with Parallel Shank	30	90	10	512.301.31
Plug Cutter	15	140	13	529.150.31
Plug Cutter	20	140	13	529.200.31
Plug Cutter	25	140	13	529.250.31
Plug Cutter	30	140	13	529.300.31

Forstner Bits

SP Z2 V2 RH



537

D mm	L mm	S mm		ORDER NO. Right-hand rotation
10	90	8	6	537.100.31
12	90	8	6	537.120.31
14	90	8	6	537.140.31
15	90	8	6	537.150.31
16	90	8	6	537.160.31
18	90	8	6	537.180.31
20	90	8	6	537.200.31
22	90	8	6	537.220.31
24	90	8	6	537.240.31
25	90	8	6	537.250.31
26	90	8	6	537.260.31
28	90	8	6	537.280.31
30	90	8	6	537.300.31
32	90	10	6	537.320.31
35	90	10	6	537.350.31
38	90	10	6	537.380.31
40	90	10	6	537.400.31
45	90	10	6	537.450.31
50	90	10	6	537.500.31
55	90	10	6	537.550.31
68	157	12,7	6	537.680.31
70	157	12,7	6	537.700.31
75	157	12,7	2	537.750.31
80	157	12,7	2	537.800.31
85	157	12,7	2	537.850.31
90	157	12,7	2	537.900.31
95	157	12,7	2	537.950.31
100	157	12,7	2	537.990.31

D inches	L inches	S inches		ORDER NO. Right-hand rotation
1/4	3-35/64	3/8	6	537.064.31
3/8	3-35/64	3/8	6	537.095.31
1/2	3-35/64	3/8	6	537.127.31
5/8	3-35/64	3/8	6	537.158.31
3/4	3-35/64	3/8	6	537.190.31
7/8	3-35/64	3/8	6	537.222.31
1	3-35/64	3/8	6	537.254.31
1-1/8	3-35/64	3/8	6	537.285.31
1-1/4	3-35/64	3/8	6	537.317.31
1-3/8	3-35/64	3/8	6	537.349.31
1-1/2	3-35/64	3/8	6	537.381.31
1-5/8	3-35/64	3/8	6	537.413.31
1-3/4	3-35/64	3/8	6	537.445.31
1-7/8	3-35/64	3/8	6	537.476.31
2	3-35/64	3/8	6	537.508.31
2-1/8	3-35/64	3/8	6	537.540.31
2-1/4	3-35/64	3/8	6	537.571.31
2-1/2	3-35/64	3/8	6	537.635.31
3	3-35/64	3/8	2	537.762.31
3-1/2	3-35/64	3/8	2	537.889.31
4	3-35/64	3/8	2	537.991.31
4-1/2	3-35/64	3/8	2	537.993.31

toothed rim $\geq \varnothing 25\text{mm}$

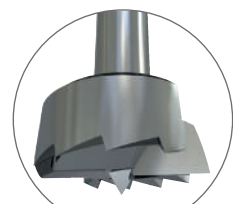

standard rim $< \varnothing 25\text{mm}$

new
new
new
new
new
new
new

STANDARD RIM AND TOOTHED RIM:

Standard rims provide better guidance but tend to overheat. To overcome heat the larger diameters ($\geq \varnothing 25\text{mm}$) are designed with toothed rims.

TECHNICAL DETAILS:

- Long-lasting cutting performance
- Super strength SP steel
- Precision balanced centre point
- 2 ground spurs [V2]
- 2 precision ground cutting edges [Z2].

APPLICATION:

for drilling precise flat bottom holes of any size in softwood. Create oval and arched openings at any angle. Create niches for the installation of brackets/straps, frames/grids.

Forstner Bit Sets

We offer a wide range of Forstner bits in the most popular diameters to execute the cleanest holes for brackets/straps in softwood. Drill ovals and arched openings at any angle for the installation of hinge parts. Available in 4, 5, 7, 12 and 16 bit sets.

537.000.16

SP Z2 V2 RH

- 537.000.04**
- 537.000.05**
- 537.000.07**
- 537.000.12**



DESCRIPTION	SHANK mm	SHANK inches	BIT DIAMETER		ORDER NO. Right-hand rotation
5 pcs. Router Bit Set in clamshell	Ø8-10		Ø15-20-25-30-35mm	6	537.000.05
12 pcs. Router Bit Set in clamshell	Ø8-10		Ø10-12-14-15-16-18-20-22-25-26-30-35mm	6	537.000.12
4 pcs. Router Bit Set in clamshell		Ø3/8	Ø1/4" - 1/2" - 3/4" - 1"	6	537.000.04
7 pcs. Router Bit Set in clamshell		Ø3/8	Ø1/4" - 3/8" - 1/2" - 5/8" - 3/4" - 7/8" - 1"	6	537.000.07
16 pcs. Router Bit Set in plastic box		Ø3/8	Ø1/4" - 3/8" - 1/2" - 5/8" - 3/4" - 7/8" - 1" - 1-1/8" - 1-1/4" - 1-3/8" - 1-1/2" - 1-5/8" - 1-3/4" - 1-7/8" - 2" - 2-1/8"	8	537.000.16



531

HW **Z2** **RH**

D mm	L mm	S mm	Max RPM		ORDER NO. Right-hand rotation
54	73,5	9,5	1500	10	531.541
54	71,3	9,5	1500	10	531.542
54	67,3	9,5	1500	10	531.543
54	72,3	9,5	1500	10	531.544
70	76,5	9,5	1000	5	531.701
70	74	9,5	1000	5	531.702

TECHNICAL DETAILS:

- Super strength steel
- 2 HW precision ground cutting edges [Z2]
- Parallel hexagonal shank
- Right-hand rotation (RH).

APPLICATION:

for use on drill presses and low speed power tools (see table above for max RPM). We recommend securely clamping your workpiece throughout drilling operations.

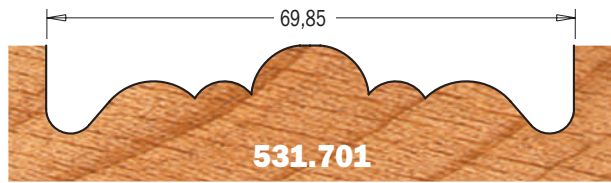
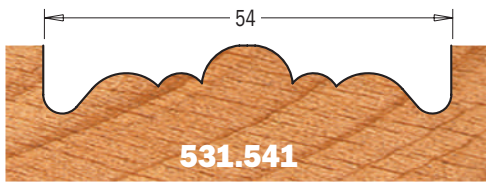

Drawings are 1:1 scale



531.541
531.701

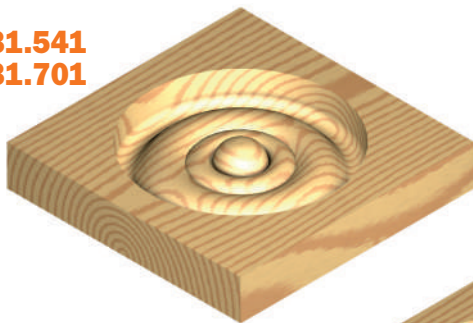

531.542
531.702

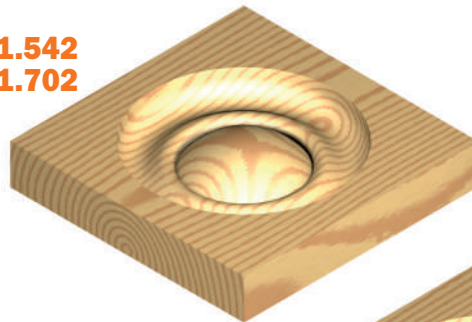

531.543

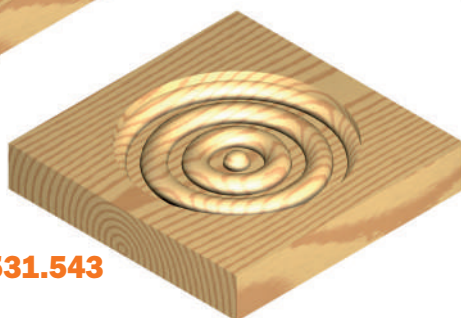

531.544

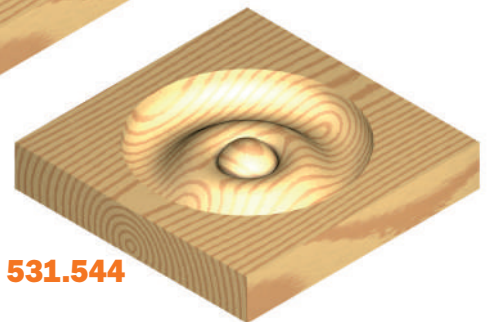

HSS Z1 V1 RH

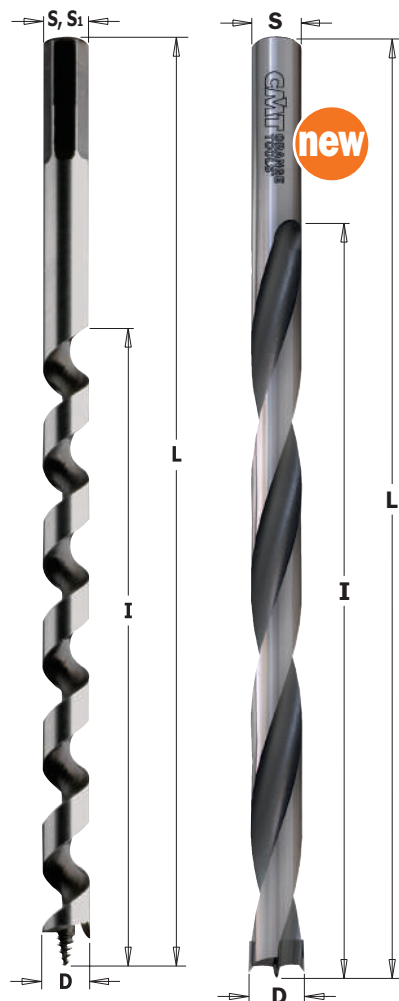

542-535

D mm	I mm	L mm	S	S ₁ mm	RPM max		ORDER NO. Right-hand rotation
6	155	230	Hexagonal	6	800 ~ 1400	1	542.060.51
8	155	230	Hexagonal	6,35	800 ~ 1400	1	542.080.51
10	155	230	Hexagonal	9	600 ~ 1200	1	542.100.51
12	155	230	Hexagonal	12	600 ~ 1100	1	542.120.51
14	155	230	Hexagonal	12	600 ~ 1000	1	542.140.51
16	155	230	Hexagonal	12	500 ~ 900	1	542.160.51
18	155	230	Hexagonal	12	500 ~ 800	1	542.180.51
20	155	230	Hexagonal	12	400 ~ 700	1	542.200.51
8	360	460	Hexagonal	6,55	800 ~ 1000	1	535.080.51
10	360	460	Hexagonal	9	600 ~ 1000	1	535.100.51
12	360	460	Hexagonal	12	600 ~ 1000	1	535.120.51
14	360	460	Hexagonal	12	500 ~ 900	1	535.140.51
16	360	460	Hexagonal	12	500 ~ 900	1	535.160.51
18	360	460	Hexagonal	12	450 ~ 800	1	535.180.51
20	360	460	Hexagonal	12	400 ~ 700	1	535.200.51

TECHNICAL DETAILS:

- Long-lasting cutting performance
- Super strength HSS steel
- Precision balanced centre point
- 1 precision ground cutting edge [Z1]
- 1 spiral flute - 1 spur [V1].

APPLICATION:

for deep boring on soft and medium-density wood. Ideal for the preparation and installation of floating shelves.

542

HW LONG LIFE Z2 RH

D mm	I mm	L mm	S mm		ORDER NO. Right-hand rotation
12	180	240	13	1	542.120.11
14	180	240	13	1	542.140.11

TECHNICAL DETAILS:

- Long-lasting cutting performance
- Super strength steel
- HW head with precision balanced centre point
- 2 precision ground cutting edges [Z2]
- 2 spiral flutes.

APPLICATION:

for deep boring on soft and medium-density wood. Ideal for the preparation and installation of floating shelves.

Brad Point Bits



540

HW Z2 V2 RH

D mm	L mm	S mm		ORDER NO. Right-hand rotation
5	90	8x30	1	540.050.11
6	90	8x30	1	540.060.11
8	90	8x30	1	540.080.11
10	90	8x30	1	540.100.11
12	90	8x30	1	540.120.11

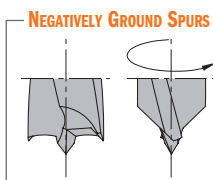

TECHNICAL DETAILS:

- Super strength steel
- HW head with precision balanced centre point
- 2 precision ground cutting edges [Z2]
- 2 spiral flutes.

APPLICATION:

for drilling blind holes in solid wood, wood derivatives and laminates. For use on hand-held power drills and drill presses.

541 Stop Collars

D mm		ORDER NO.
5	10	541.050.00
6	10	541.060.00
8	10	541.080.00
10	10	541.100.00
12	10	541.120.00

Spare parts

990.002.00	991.062.00
990.002.00	991.062.00
990.002.00	991.062.00
990.002.00	991.062.00
990.002.00	991.062.00

Stop collars with precision clamping nut and key for quick and easy assembly.

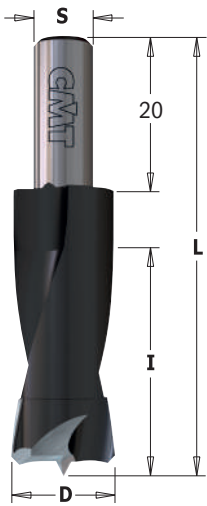

312

HW Z2 RH

D mm	I mm	L mm	S mm		ORDER NO. Right-hand rotation
4	30	58	8	10	312.040.11
5	30	58	8	10	312.050.11
6	30	58	8	10	312.060.11
8	30	58	8	10	312.080.11
10	30	58	8	10	312.100.11
12	30	58	8	10	312.120.11
14	30	58	8	10	312.140.11
16	30	58	8	10	312.160.11

These drill bits are made with high-strength steel to facilitate high speed rotation. Perfect for creating blind holes in solid wood, wood derivatives and laminates. For use on hand-held routers and MAFELL® machines - model DD40

Spare parts 990.003.00

Optional 990.088.00

TECHNICAL DETAILS:

- Super strength steel
- Black P.T.F.E. coating
- HW precision balanced centre point
- 2 HW precision ground cutting edges [Z2]
- No lateral spurs
- 2 spiral flutes
- Parallel shank with driving flat and length adjusting screw.

SHARPENING WITH CHAMFER

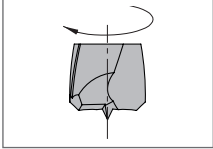

Router Bits for DOMINO® Joining Machines by FESTOOL®

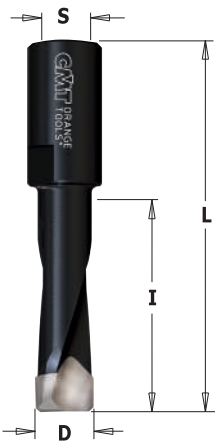

380

HW HWM Z2 RH

D mm	I mm	L mm	S mm	FESTOOL®		ORDER NO. Right-hand rotation
• 4	11	38	M6x0,75	DF500	10	380.040.11
5	20	49	M6x0,75	DF500	10	380.050.11
6	28	49	M6x0,75	DF500	10	380.060.11
8	28	49	M6x0,75	DF500	10	380.080.11
10	28	49	M6x0,75	DF500	10	380.100.11
8	50	90	M8x1	DF700	10	380.081.11
10	70	90	M8x1	DF700	10	380.101.11
12	70	90	M8x1	DF700	10	380.121.11
14	70	90	M8x1	DF700	10	380.141.11

• **HWM**

TECHNICAL DETAILS:

- Premium quality super-strength steel
- Black P.T.F.E. coating
- HWM head
- No lateral spurs
- 2 cutting edges [Z2]
- 2 spiral flutes.

APPLICATION:

for use on "DOMINO® machines to rout slots for hinges.



Brad Point Bits

SP HSS Z2 RH

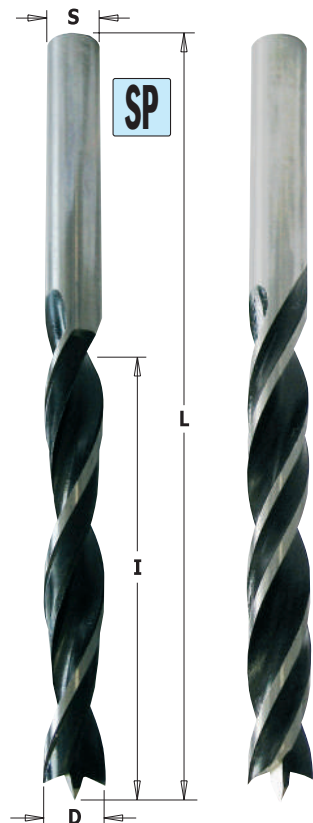

517

D mm	I mm	L mm	S mm		ORDER NO.	ORDER NO.
					Right-hand rotation	Right-hand rotation
3	33	61	3,0	1	517.030.31	517.030.51
4	43	75	4	1	517.040.31	517.040.51
4,5	47	80	4,5	1		517.045.51
5	52	86	5	1	517.050.31	517.050.51
6	57	93	6	1	517.060.31	517.060.51
7	69	109	7	1	517.070.31	517.070.51
8	75	117	8	1	517.080.31	517.080.51
9	80	120	9	1	517.090.31	517.090.51
10	80	120	10	1	517.100.31	517.100.51
11	89	142	8	1	517.110.31	517.110.51
12	96	151	8	1	517.120.31	517.120.51
13	96	151	8	1	517.130.31	517.130.51
14	96	151	10	1	517.140.31	517.140.51
15	100	160	10	1	517.150.31	517.150.51
16	100	160	10	1	517.160.31	517.160.51
18	130	180	10	1	517.180.31	
20	135	200	10	1	517.200.31	

SP

TECHNICAL DETAILS:

- Super strength SP steel
- Precision balanced center point
- 2 precision ground SP cutting edges [Z2]
- 2 flutes.

APPLICATION:

for drilling holes in natural wood.

HSS

TECHNICAL DETAILS:

- Super strength HSS steel
- Long lasting cutting performance
- Precision balanced center point
- 2 precision ground cutting edges [Z2]
- 4 spiral flutes.

APPLICATION:

used for drilling holes in soft and hardwood.
Long-lasting cutting performance.

Brad Point Bit Sets

HSS SP Z2 RH



517

5-Piece Brad Point Bit Set

An economical collection of the five most popular sized brad points - 4, 5, 6, 8 and 10mm. Safely packaged in a reusable plastic case for easy storage and access.

8-Piece Brad Point Bit Set

A complete collection of the most popular brad points in the most requested sizes - 3, 4, 5, 6, 7, 8, 9 and 10mm. Safely packaged in a reusable plastic case for easy storage and access.

DESCRIPTION	Z	BIT DIAMETER		ORDER NO. Right-hand rotation
5-Pcs. HSS Brad Point Set	4 flutes	Ø4-5-6-8-10mm	50	517.001.01
5-Pcs. SP Brad Point Set	2 flutes	Ø4-5-6-8-10mm	50	517.001.00
8-Pcs. HSS Brad Point Set	4 flutes	Ø3-4-5-6-7-8-9-10mm	30	517.002.01
8-Pcs. SP Brad Point Set	2 flutes	Ø3-4-5-6-7-8-9-10mm	30	517.002.00

Brad Point Bits

HSS Z2 RH LH

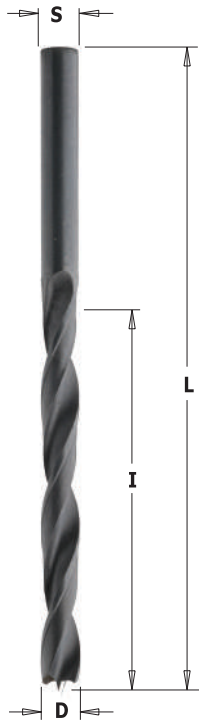

516

D mm	I mm	L mm	S mm		ORDER NO. Right-hand rotation	ORDER NO. Left-hand rotation
2	24	49	2	10	516.020.51	516.020.52
2,5	30	57	2,5	10	516.025.51	516.025.52
3	33	61	3	10	516.030.51	516.030.52
3,5	39	70	3,5	10	516.035.51	516.035.52
4	43	75	4	10	516.040.51	516.040.52
4,5	47	80	4,5	10	516.045.51	516.045.52
5	52	86	5	10	516.050.51	516.050.52
5,5	57	93	5,5	10	516.055.51	516.055.52
6	57	93	6	10	516.060.51	516.060.52
7	69	109	7	10	516.070.51	516.070.52
8	75	117	8	10	516.080.51	516.080.52
9	81	125	9	10	516.090.51	516.090.52
10	87	133	10	10	516.100.51	516.100.52

- TECHNICAL DETAILS:**
- Super strength HSS steel
 - Long lasting cutting performance
 - Precision balanced centre point
 - 2 precision ground cutting edges [Z2]
 - 2 spiral flutes
 - Common shank and cutting diameter (S=D).

APPLICATION:
for drilling blind holes in soft and medium-density wood.

Drill Bits for ANUBA® Hinges

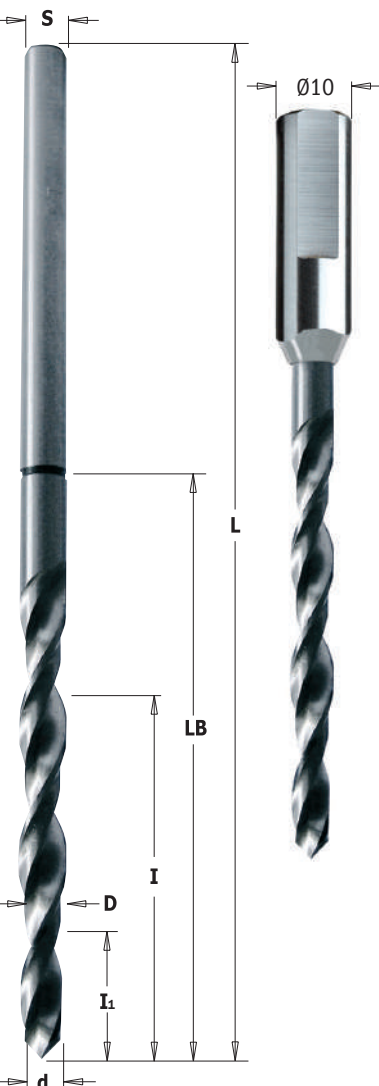

515

HSS Z2 RH

ANUBA® nr.	d mm	D-S mm	I ₁ mm	I mm	LB mm	L mm		ORDER NO. Right-hand rotation
9,5	3,8	5,2	18	56	74	132	1	515.095.51
11	4,8	5,7	17	60	76	145	1	515.110.51
13	5,8	6,7	18	68	83	155	1	515.130.51
14,5	6,3	7,2	19	75	89	165	1	515.145.51
16	6,7	7,7	25	85	100	165	1	515.160.51
18	7,7	8,7	25	85	102	165	1	515.180.51
20	8,8	9,8	25	90	104	165	1	515.200.51

Parallel Shank with Driving Flat

ANUBA® nr.	d mm	D mm	I mm	LB mm	S mm	L mm		ORDER NO. Right-hand rotation
13	5,2	6,5	15	50	10x35	85	1	515.131.51
14	5,5	7	15	55	10x35	90	1	515.141.51
16	6	7,7	15	60	10x35	95	1	515.161.51

- TECHNICAL DETAILS:**
- Super strength HSS steel
 - 2 HSS precision ground cutting edges [Z2]
 - 2 spiral flutes.

APPLICATION:
for drilling holes in medium density wood.
For the installation of ANUBA® hinges.



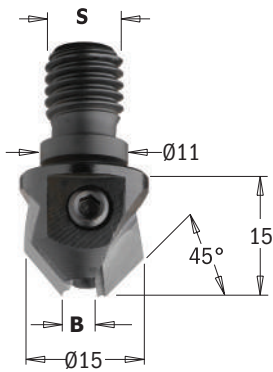

350



B mm	S mm		10	ORDER NO. Right-hand rotation	ORDER NO. Left-hand rotation
3	M10/Ø11x4		10	350.030.11	350.030.12
4	M10/Ø11x4		10	350.040.11	350.040.12
5	M10/Ø11x4		10	350.050.11	350.050.12

TECHNICAL DETAILS:

- Super strength steel
- 2 HW precision ground cutting edges [Z2]
- Fastening screw for quick and easy drill bit change.

Spare parts



990.001.00

APPLICATION:

for use with spiral bits featuring a parallel shank of equal dimension to countersink shank diameter.

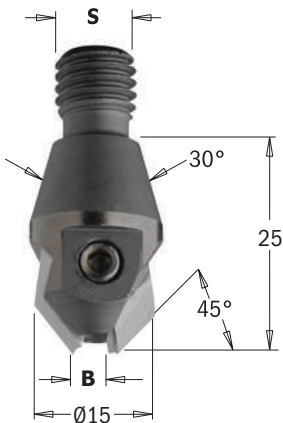

351

B mm	S mm		10	ORDER NO. Right-hand rotation	ORDER NO. Left-hand rotation
3	M10/30°		10	351.030.11	351.030.12
4	M10/30°		10	351.040.11	351.040.12
5	M10/30°		10	351.050.11	351.050.12

TECHNICAL DETAILS:

- Super strength steel
- 2 HW precision ground cutting edges [Z2]
- Fastening screw for quick and easy drill bit change.

Spare parts



990.001.00

APPLICATION:

for use with spiral bits featuring a parallel shank of equal dimension to countersink shank diameter.

Adjustable Countersink

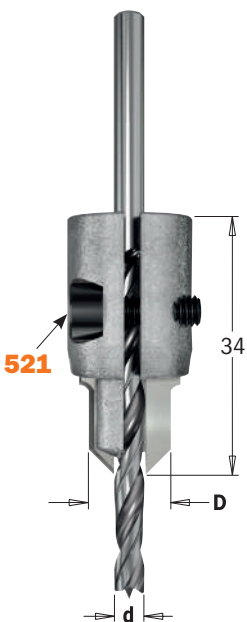

521.001



d mm	D mm	10	ORDER NO. Right-hand rotation	Spare parts	
3 ~ 7	11 ~ 15	10	521.001.11	990.061.00	991.067.00

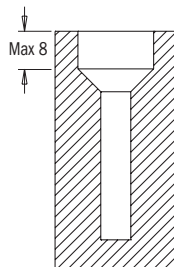

TWIST DRILLS	OVERALL DIAMETER
Ø3	Ø11
Ø4	Ø12
Ø5	Ø13
Ø6	Ø14
Ø7	Ø15

TECHNICAL DETAILS:

- Super strength steel
- 2 HW precision ground cutting edges [Z2]
- Fastening screw for quick and easy drill bit change.

APPLICATION:

for use with spiral bits featuring a parallel shank of equal dimension to countersink shank diameter.

Twist drill bit NOT included

Drill Bits with 45° Countersink Set

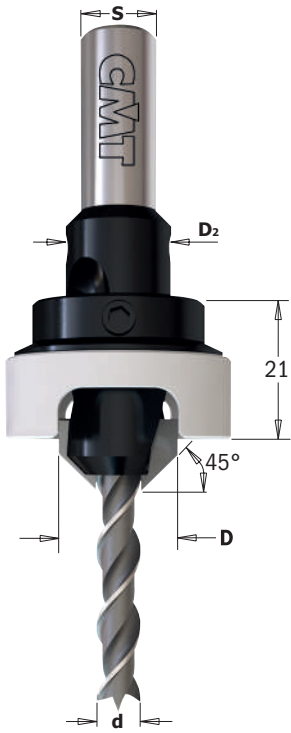

521A

d mm	D mm	D ₂ mm	A	S mm		ORDER NO. Right-hand rotation
3	12	10	45°	8	10	521.312.11A
4	12	10	45°	8	10	521.412.11A
4,5	16	14	45°	10	10	521.4516.11A
5	16	14	45°	10	10	521.516.11A
6	16	14	45°	10	10	521.616.11A

new

Spare parts: **990.014.00** Screw
991.060.00 Hex key

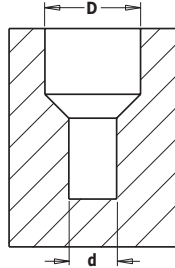

TECHNICAL DETAILS:

- Super strength steel
- Countersink: 2 HW precision ground cutting edges [Z2].

APPLICATION:

for drilling countersink and blind holes in solid wood, wood derivatives and laminates. For use with hand-held power drills or drill presses.

Stop collars with precision clamping nut for quick and easy assembly. The DELRIN® protection sleeve lets you work without marring the workpiece.



Spare parts

521.312.11	517.030.51P	541.101.00
521.412.11	517.040.51P	541.101.00
521.4516.11	517.045.51P	541.141.00
521.516.11	517.050.51P	541.141.00
521.616.11	517.060.51P	541.141.00

Drill Bits with 90° Countersink Set

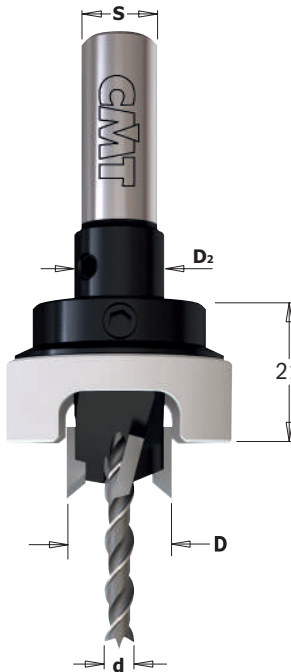

515A

d mm	D mm	D ₂ mm	S mm		ORDER NO. Right-hand rotation
4	12	10	10	10	515.412.11A
4	14	12	10	10	515.414.11A
4	15	14	10	10	515.415.11A
5	15	14	10	10	515.515.11A
6	14	12	10	10	515.614.11A
6	15	14	10	10	515.615.11A

new

Spare parts: **990.014.00** Screw
991.060.00 Hex key

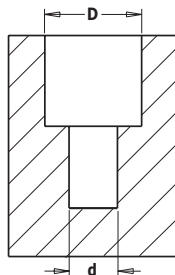

TECHNICAL DETAILS:

- Super strength steel
- Countersink: 2 HW precision ground cutting edges [Z2]
- Countersink: 2 HW negatively ground spurs [V2].

APPLICATION:

for drilling countersink and blind holes in solid wood, wood derivatives and laminates. For use with hand-held power drills or drill presses.

Stop collars with precision clamping nut for quick and easy assembly. The DELRIN® protection sleeve lets you work without marring the workpiece.



Spare parts

515.412.11	517.040.51P	541.101.00
515.414.11	517.040.51P	541.121.00
515.415.11	517.040.51P	541.141.00
515.515.11	517.050.51P	541.141.00
515.614.11	517.060.51P	541.121.00
515.615.11	517.060.51P	541.141.00

Stop Collars with DELRIN® Sleeve

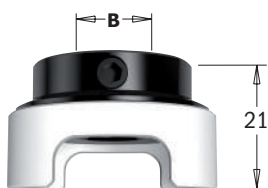

541

B mm		ORDER NO.
10	1	541.101.00
12	1	541.121.00
14	1	541.141.00

Spare parts

990.014.00	991.060.00
990.014.00	991.060.00
990.014.00	991.060.00

Stop collars with precision clamping nut for quick and easy assembly. The DELRIN® protection sleeve lets you work without leaving marks on the workpiece.

45° Countersink with Parallel Shank

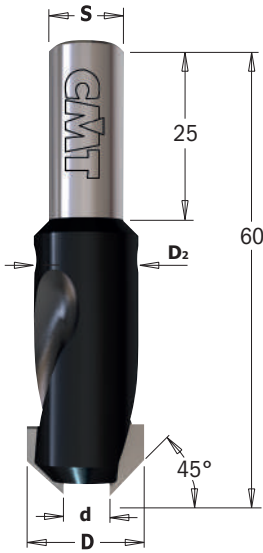

521



d mm	D mm	D ₂ mm	A	S mm		ORDER NO. Right-hand rotation	ORDER NO. Left-hand rotation
3	12	10	45°	8	10	521.312.11	521.312.12
4	12	10	45°	8	10	521.412.11	521.412.12
4,5	16	14	45°	10	10	521.4516.11	
5	16	14	45°	10	10	521.516.11	521.516.12
6	16	14	45°	10	10	521.616.11	521.616.12

Spare parts

	990.014.00
	990.014.00
	990.014.00
	990.014.00
	990.014.00

new

Spare parts: 991.060.00 2mm hex key

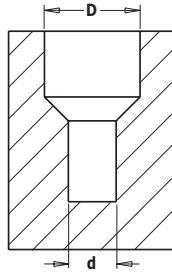

TECHNICAL DETAILS:

- Super strength steel
- 2 HW precision ground cutting edges [Z2].

APPLICATION:

for use with spiral bits featuring a parallel shank of equal dimension to countersink shank diameter.

90° Countersink with Parallel Shank

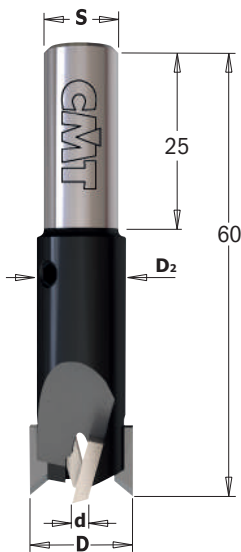

515



d mm	D mm	D ₂ mm	A	S mm		ORDER NO. Right-hand rotation	
4	12	10	90°	10	10	515.412.11	
4	14	12	90°	10	10	515.414.11	
4	15	14	90°	10	10	515.415.11	
5	15	14	90°	10	10	515.515.11	
6	14	12	90°	10	10	515.614.11	
6	15	14	90°	10	10	515.615.11	

Spare parts

	990.014.00
	990.014.00
	990.014.00
	990.014.00
	990.014.00
	990.014.00

new

Spare parts: 991.060.00 2mm hex key

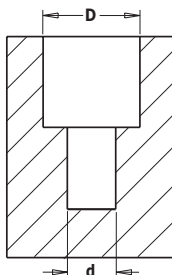

TECHNICAL DETAILS:

- Super strength steel
- 2 HW precision ground cutting edges [Z2]
- 2 HW negatively ground spurs [V2].

APPLICATION:

for use with spiral bits featuring a parallel shank of equal dimension to countersink shank diameter.

90° Solid Carbide Countersink with Parallel Shank

HWM Z3 RH

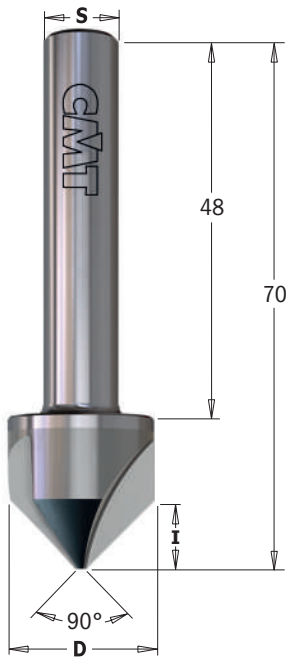

521

D mm	I mm	L mm	S mm		ORDER NO. Right-hand rotation
19,5	9	70	10x48	10	521.002.11

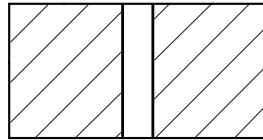
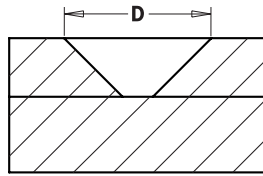

For drilling use bits serie **516** or **517**

TECHNICAL DETAILS:

- For making 90° countersink blind holes accepting flat-head fasteners that sit flush with the surface.
- 3 wear-resistant precision ground cutting edges providing a smooth finish on hardened materials.
- Solid carbide tool that is harder than cobalt steel, providing a longer tool life at higher speeds.
- Parallel shank to accommodate most drill chucks.
- Suitable for wood, wood-based, non-ferrous materials and metal.

Drill Bit with Countersink for Screw Joints

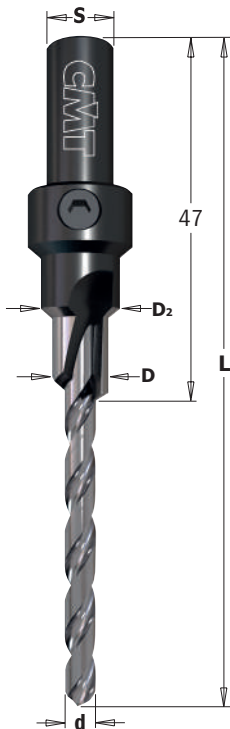

515

SP Z1 RH

d mm	D mm	D ₂ mm	L mm	S mm		ORDER NO. Right-hand rotation
4,2	7,6	10,6	87	9	1	515.042.31
5	7,6	10,6	93,7	9	1	515.050.31

TECHNICAL DETAILS:

- Super strength SP steel
- Long lasting cutting performance
- 1 SP precision ground cutting edge [Z1]
- 1 spiral flute.

APPLICATION:

for drilling blind holes in soft and hardwood.

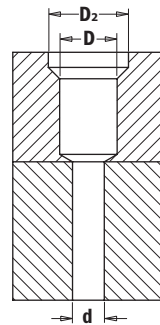

CMT FASTX4 THE HOLE SAW REVOLUTION

An innovative new system that offers great advantages to all professionals!

X1 FAST LOCK

ALL IN ONE CLICK!

A unique patented Fast Lock System which enables quick changes between cylinder sizes and types in seconds! The only system that allows hole saw cylinder and pilot drill parts to be changed without tool assistance.



X2 FAST DRILL

FAST DRILLING IN ALL CONDITIONS!

Our hole saws have unique body geometry and specially sharpened teeth which provide fast, precise cutting, even at extreme angles.

- pre-drill at the desired angle
- push the hole saw forward back in position and complete the hole.



X3 FAST BORE ENLARGEMENT

BORE ENLARGEMENT MADE EASY!

CMT has a flash solution for bore enlargement. Our innovative pilot drill bit can fit two hole saws at once, allowing you to broaden a hole in mere seconds.



X4 FAST PLUG REMOVAL

PLUG REMOVAL IN ONE QUICK CLICK!

No more screwdrivers or fastening tools! Remove the plug effortlessly simply by reversing the pilot drill bit.

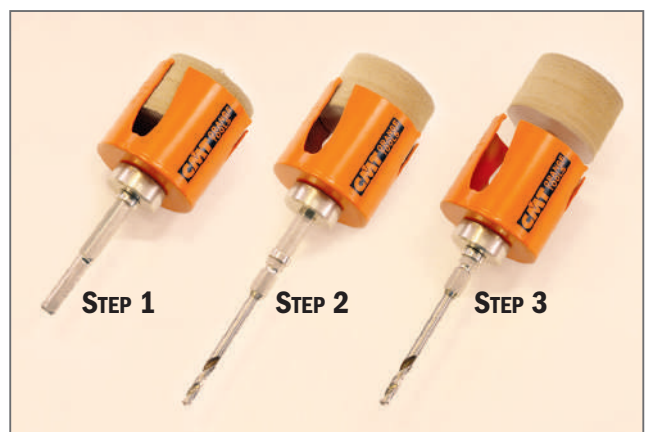

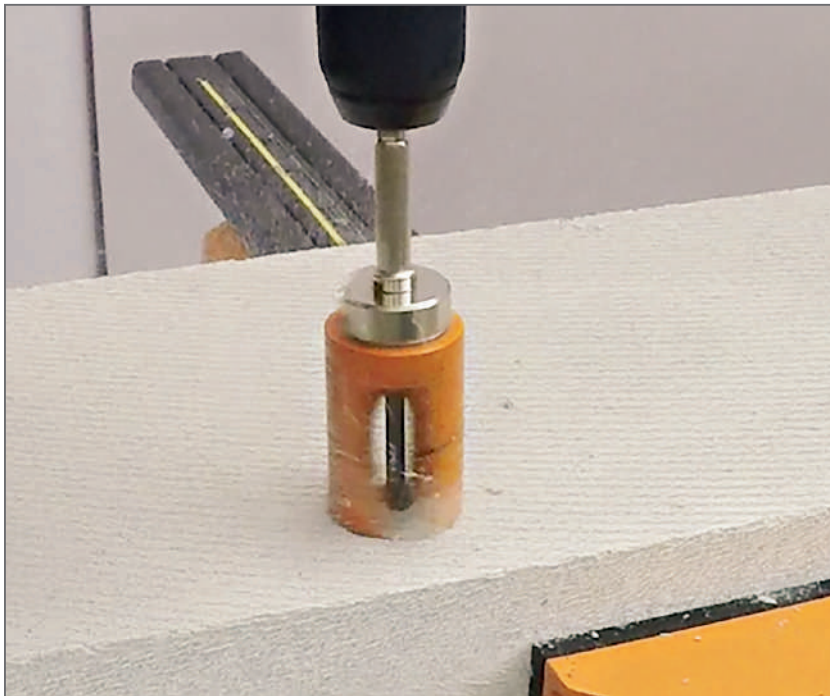

HOLE SAWS

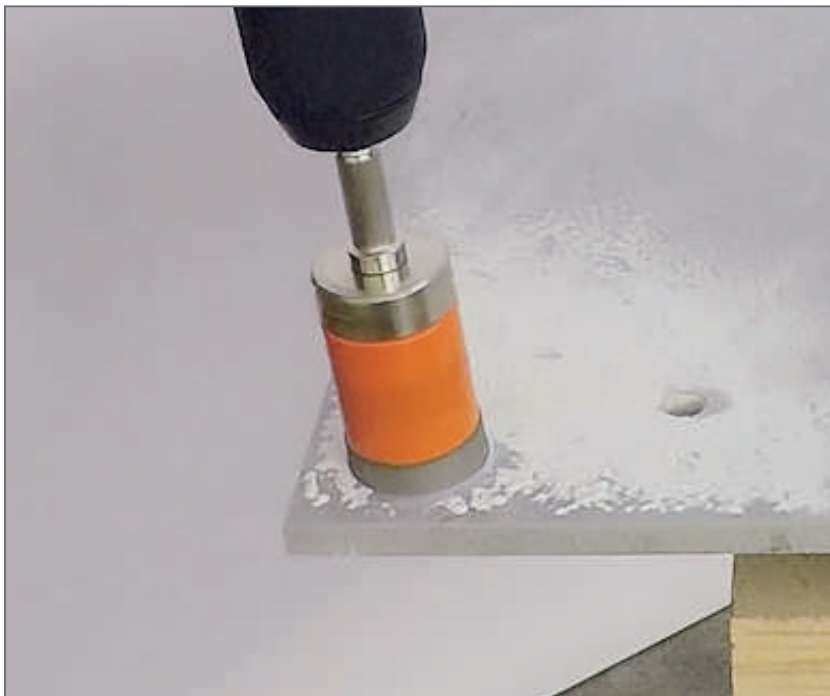

PRODUCTS	PAGE
Bi-Metal Plus 8% Cobalt	FASTX4 366-367
Tungsten Carbide-Tipped	FASTX4 368-369
Tungsten Carbide-Tipped Long	FASTX4 370
Diamond Dry	FASTX4 371
Diamond Dry	372
Diamond Dry for Angle Grinder	373
Diamond Dry Special Bits for Angle Grinder	374-375
Diamond Dry Wheels for Angle Grinder	375

Watch the video on



FASTX4 SYSTEM: THE HOLE SAW REVOLUTION!

The innovative patented FASTX4 system makes the hole saw arbor obsolete. These hole saws have been specifically designed to ensure maximum productivity, lifetime and performance in all materials. CMT offers a professional range for electricians, carpenters, builders, kitchen fitters and all related heating, ventilation and plumbing trades.

SERIES 550 TUNGSTEN CARBIDE-TIPPED SERIES 553 TUNGSTEN CARBIDE-TIPPED LONG



5X
FASTER

10X
LONGER LIFE



LONG LASTING CONSTRUCTION GRADE CARBIDE.
Specially formulated construction grade carbide used for cutting teeth provide 10 times longer cutting life.

Tungsten carbide-tipped multi-purpose hole saws are designed for use in a wide variety of materials such as soft and hardwoods, chipboard, plywood, MDF, plastic, gypsum/plasterboard, soft tiles (surface hardness ≤ 6 Mohs), solid brick, brick with cavities, aerated concrete block, lightweight aggregate block, breeze block and soft density lime-sandstone building block (max 30 N/mm² hardness).

SERIES 551 BI-METAL PLUS 8% COBALT



2X
LONGER LIFE

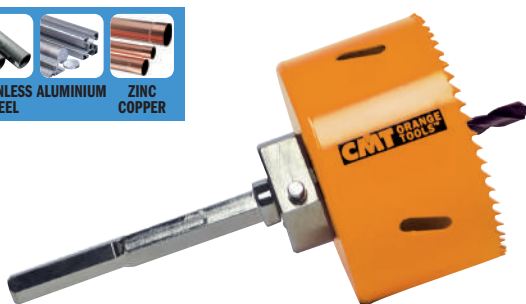

BI-METAL PLUS 8% COBALT
Premium bi-metal with 8% Cobalt provides Xtreme results in performance and up to 50% longer lifetime than the competition.

Special tooth geometry with regular pitch provides smoother cuts and better chip clearance preventing clogging and heat build-up. Teeth are alternate & side set to minimize binding and friction requiring less feed pressure. Ideal for mild steel (up to 1000 N/mm² strength), stainless steel, non-ferrous metal, aluminium, cast iron, copper and galvanized sheet metal.

SERIES 552 DIAMOND DRY

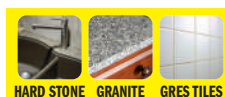

10X
LONGER LIFE

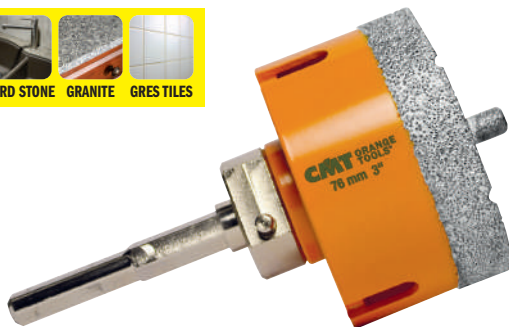

DIAMOND GRIT PREMIUM GRADE
Diamond grit featuring strong cubo-octahedral inclusion-free heat-resistant crystals guarantees fast clean cutting and 10 times longer lifetime.

The diamond dry continuous edge hole saw was specially developed for drilling very hard materials such as tile (ceramic, gres, etc.), hard stone (granite, marble, etc.) and artificial stone (OKITE®, SILESTONE®, etc.), applications far too daunting for the conventional hole saw. These hole saws guarantee excellent performance and superior lifetime even in the most challenging materials.

EYE-CATCHING PACKAGING



03.01.0297 (empty box)



03.01.0296 (empty box)



Teeth are protected with heat shrink wrap

The number of holes is approximate. Feed speed, coolant, material type/quality/thickness and proper use of the tool will directly influence performance values and life span.

MATERIAL		SERIES 550 553	SERIES 551	SERIES 552	TIPS
Soft and hardwood		>500 holes	<30 holes		
Plywood, counter-tops		>500 holes	<30 holes		
MDF, chipboard, veneer		>500 holes	<30 holes		
Laminate, TRESPA®, HPL		>500 holes	<10 holes		
Gypsum and plasterboard		>500 holes	<50 holes		
Fibercement board, ETERNIT®		>50 holes	<10 holes		
Sandwich materials			50~75 holes		
Plastic		>100 holes	<20 holes		
Fiberglass		50~100 holes			
Acrylic glass		>100 holes			
Roofing & soft tile		>50 holes			Not suitable for ceramic tiles
Solid brick, masonry		>50 holes			
Perforated brick		>50 holes			
Lime brick		>50 holes			
Porous and lightweight concrete		>500 holes	<20 holes		
Metal and thin sheet metal			10~40 holes		Use coolant oil
Non-ferrous metal			50~75 holes		Use coolant oil
Aluminium			50~75 holes		Use coolant oil
Stainless steel			30~50 holes		Use coolant oil. Low speed.
Cast iron			5~10 holes		Use coolant oil
Copper, galvanized sheet metal, brass			50~75 holes		Use coolant oil
Tile (porcelain, gres, quarry)				10~50 holes	Reapply lubricating wax on diameters ranging from Ø5mm to Ø16mm
Hard stone (granite, marble), OKITE®				10~50 holes	Reapply lubricating wax on diameters ranging from Ø5mm to Ø16mm

Examples of applications based on diameter and user (may vary from country to country)

Diameter in mm	19	22	25	30	35	40	44	48	51	54	57	60	64	68	70	76	83	86	92	102	105	127	152	User			
Fitted light	•	•	•	•	•	•	•	•	•	•	•	•	•	•	•	•	•	•	•	•	•	•	•	Electrician			
Cable feedthrough box				•	•							•							•						Electrician		
Switch boxes													•													Electrician	
Plug sockets														•													Electrician
Junction boxes															•	•											
Distributor boxes																	•	•						Electrician			
Air conditioning pipes																				•	•				Heating fitter		
Sanitary and heating pipes	•		•	•	•																					Plumber and heating fitter	
Sanitary, drain and water pipes (insulated)						•	•	•																			Plumber and heating fitter

551

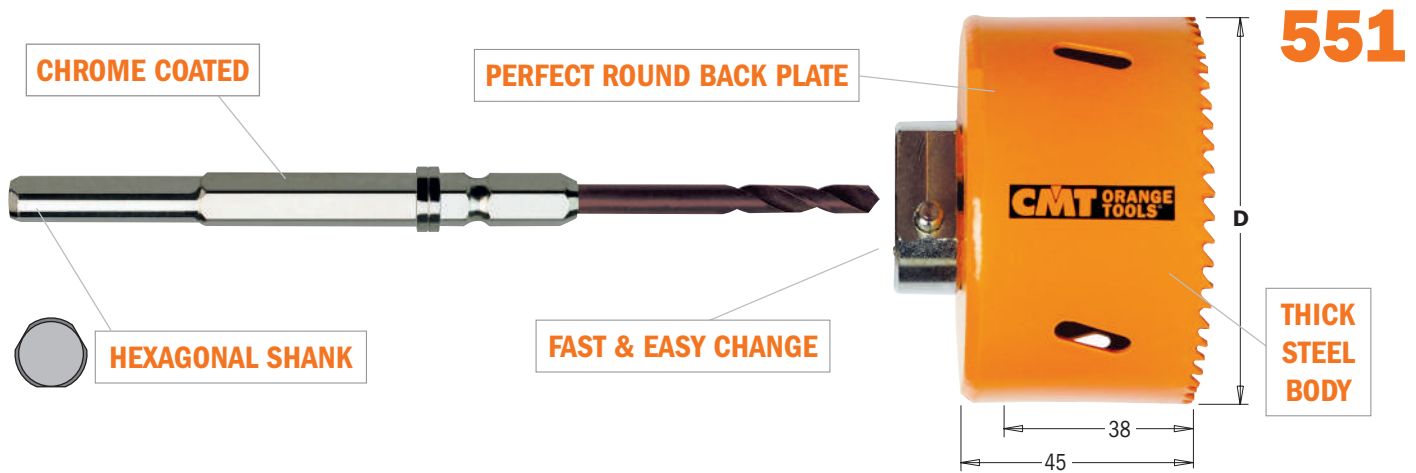

MATERIALS

- metals (up to 1000 N/mm2 strength)
- mild steel,
- stainless steel
- non-ferrous metals, aluminum
- sandwich materials
- cast iron
- copper, galvanized sheet metal, brass
- Stainless



BI-METAL PLUS 8% COBALT

Premium bi-metal with 8% cobalt provides outstanding performance and extends lifetime up to 50% longer than the competition.



ALTERNATE & SIDE SET TEETH



TOOTH DESIGN

Special tooth geometry with regular pitch provides a smoother cut and better chip clearance preventing clogging and heat build-up. Teeth are alternate & side set to minimize binding and friction requiring less feed pressure.

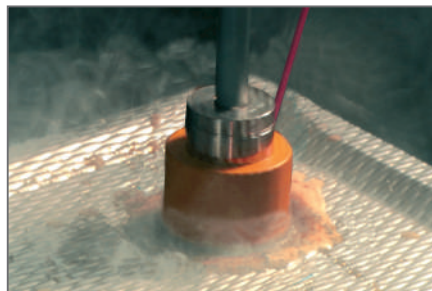

Stainless steel and cast iron



Galvanized sheet metal, aluminium and copper



SPEED KILLS!

Operating at higher speeds than those indicated will shorten hole saw life and produce very inefficient cutting.



FEED PRESSURE:

Always consider materials in use and project type. Apply sufficient feed pressure to aid proper chip removal. Reduce the pressure when hole saw becomes hot or if teeth start to clog. Insufficient feed pressure will lead to premature tooth dulling. Too much pressure will totally destroy teeth.



COOLING LUBRICANT:

When drilling metals, lubrication serves several purposes :

- it cools the saw and workpiece
- it reduces heat and abrasion which shortens cutting life
- it helps remove swarf from the cutting surface
- it extends hole saw life by 500%.



Never use hammer mechanism with these holesaws!



mm	D inches	METAL RPM	STAINLESS STEEL RPM	CAST IRON RPM	ALUMINIUM RPM	S		ORDER NO.
16	5/8	550	270	370	800	Hexagonal	10	551-016 ■
19	3/4	470	230	310	670	Hexagonal	10	551-019 ■
20	13/16	440	220	290	640	Hexagonal	10	551-020 ■
22	7/8	400	200	270	580	Hexagonal	10	551-022 ■
25	1	350	170	230	510	Hexagonal	10	551-025 ■
27	1-1/16	330	160	220	470	Hexagonal	10	551-027 ■
29	1-1/8	310	150	200	440	Hexagonal	10	551-029 ■
30	1-3/16	300	140	190	430	Hexagonal	10	551-030 ■
32	1-1/4	280	140	180	400	Hexagonal	10	551-032 ■
35	1-3/8	250	120	170	370	Hexagonal	10	551-035 ■
38	1-1/2	230	110	150	340	Hexagonal	10	551-038 ■
40	1-9/16	220	110	150	320	Hexagonal	10	551-040 ■
43	1-11/16	210	100	140	300	Hexagonal	10	551-043 ■
44	1-3/4	200	100	130	290	Hexagonal	10	551-044 ■
48	1-7/8	180	90	120	270	Hexagonal	10	551-048 ■
51	2	170	85	110	250	Hexagonal	10	551-051 ■
52	2-1/16	160	80	110	240	Hexagonal	10	551-052 ■
54	2-1/8	160	80	110	240	Hexagonal	10	551-054 ■
57	2-1/4	160	75	100	220	Hexagonal	10	551-057 ■
64	2-1/2	140	70	90	205	Hexagonal	10	551-064 ■
65	2-9/16	140	70	90	205	Hexagonal	10	551-065 ■
70	2-3/4	130	60	80	185	Hexagonal	10	551-070 ■
73	2-7/8	120	60	80	180	Hexagonal	10	551-073 ■
76	3	120	55	75	170	Hexagonal	10	551-076 ■
79	3-1/8	110	55	70	165	Hexagonal	10	551-079 ■
83	3-1/4	105	50	70	155	Hexagonal	10	551-083 ■
86	3-3/8	105	50	65	150	Hexagonal	10	551-086 ■
89	3-1/2	100	50	65	145	Hexagonal	10	551-089 ■
92	3-5/8	95	45	60	140	Hexagonal	10	551-092 ■
102	4	85	45	55	130	Hexagonal	5	551-102 ■
105	4-1/8	80	40	55	120	Hexagonal	5	551-105 ■
108	4-1/4	80	40	55	120	Hexagonal	5	551-108 ■
114	4-1/2	80	40	55	120	Hexagonal	5	551-114 ■
127	5	70	35	45	90	Hexagonal	2	551-127 ■
133	5-1/4	65	35	45	90	Hexagonal	2	551-133 ■
140	5-1/2	65	30	40	85	Hexagonal	2	551-140 ■
152	6	55	25	35	75	Hexagonal	2	551-152 ■
168	6-5/8	55	25	35	75	Hexagonal	2	551-168 ■

■ Until stock last

Cooling



CUTTING OIL

CUTTING OIL

DRY

TURPENTINE



551-HS1

For Bi-Metal PLUS hole saws **Ø16-30mm** (5/8" - 1-3/16").
Hexagonal shank for **10mm** (25/64") chuck, HSS centering tip, total length 160mm (6-5/16").

PACK QTY.
10 PC



551-HS2

For Bi-Metal PLUS hole saws **Ø32mm** (1-1/4") and above.
Hexagonal shank for **13mm** (1/2") chuck, HSS centering tip, total length 160mm (6-5/16").

FASTX4 Multi-Purpose Hole Saws

CMT ORANGE TOOLS®

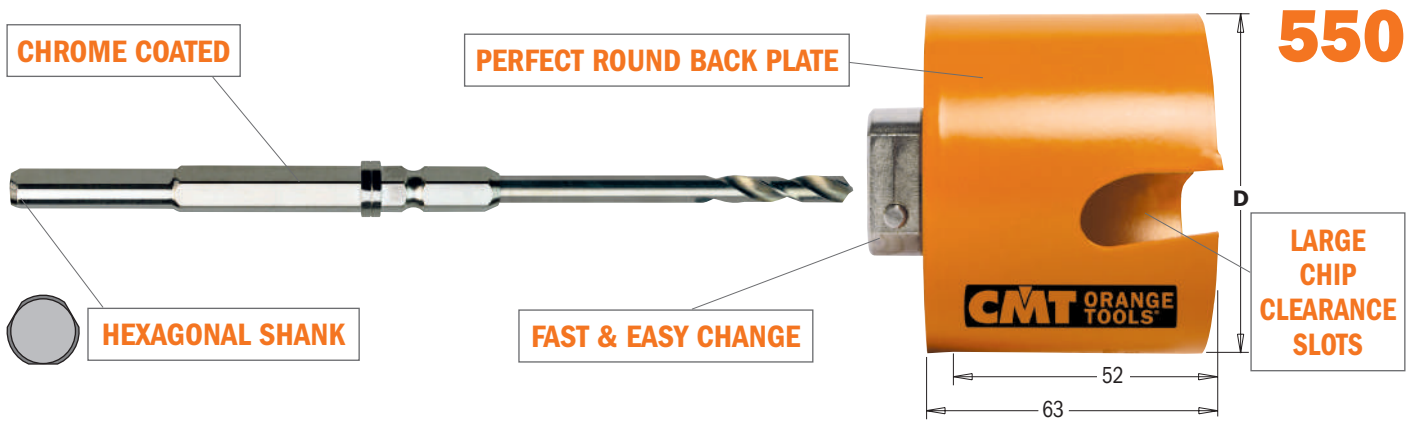

HW **LONG LASTING CONSTRUCTION GRADE CARBIDE.**
Cutting teeth made from specially formulated construction grade carbide which provides longer cutting life.



SECURED TOOTH TECHNOLOGY
Thanks to advanced technology, cutting teeth are securely anchored which means they stand up to hard materials and resist breakage.

10X LONGER LIFE **5X FASTER**



Effortless plug removal thanks to integrated slots providing leverage.

MATERIALS

- soft, hardwood and plywood
- chipboard, MDF, veneer, laminate and counter-tops (pre-drill the laminate/melamine by using left-hand rotation for clean finishing)
- gypsum, plasterboard, fibercement board, ETERNIT®
- plastic (TRESPA®, PVC, nylon, polyester)
- fiberglass and acrylic glass
- soft tile (surface hardness ≤ 6 Mohs), solid brick and brick with cavities, aerated concrete block, lightweight aggregate block and breeze block, soft density lime-sandstone building block (max 30 N/mm² hardness); for hardness >30 N/mm² use diamond dry hole saws.



Soft tile (surface hardness ≤ 6 Mohs)



Wood & MDF



TRESPA® & Plastic

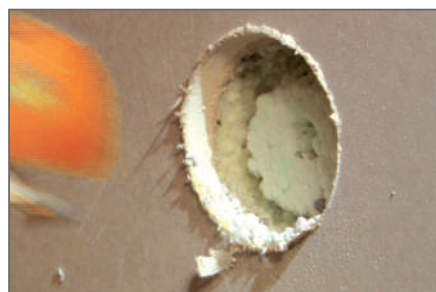

Plasterboard



Soft brick



Lime bricks



For optimum cutting lifetime, always follow speed recommendations!
Speed affects hole quality. For best results, use the centering tip to pre-bore.
Never use hammer mechanism with these hole saws.



NEVER USE HAMMER MECHANISM

mm	D inches	Z	WOOD & MDF RPM	PVC & FIBERGLASS RPM	MASONRY, BRICK RPM	SOFT TILE RPM	S		ORDER NO.
19	3/4	1	1.600	1.000	1.000	640	Hexagonal	10	550-019 ■
20	13/16	1	1.600	1.000	1.000	640	Hexagonal	10	550-020 ■
30	1-3/16	1	1.070	910	910	430	Hexagonal	10	550-030 ■
38	1-1/2	2	840	720	720	340	Hexagonal	10	550-038 ■
40	1-9/16	2	800	680	680	320	Hexagonal	10	550-040 ■
48	1-7/8	2	680	580	580	270	Hexagonal	10	550-048 ■
52	2-1/16	3	620	530	530	250	Hexagonal	10	550-052 ■
56	2-3/16	3	570	490	490	230	Hexagonal	10	550-056 ■
185	7-1/4	7	200	150	150	120	Hexagonal	2	550-185 ■
210	8-1/4	7	200	150	150	120	Hexagonal	1	550-210 ■
225	8-7/8	9	160	120	120	95	Hexagonal	1	550-225 ■
260	10-1/4	9	150	110	110	80	Hexagonal	1	550-260 ■
270	10-5/8	9	140	100	100	70	Hexagonal	1	550-270 ■

■ Until stock last

Hole Saws Accessories

PACK QTY.
10 PC

550-HS1 For Ø20-30mm (25/32" - 1-3/16")
Hexagonal shank for 10mm (25/64") chuck, HSS centering tip, total length 180mm (7-5/64").



550-HW1 For Ø20-30mm (25/32" - 1-3/16")
Hexagonal shank for 10mm (25/64") chuck, HW centering tip, total length 180mm (7-5/64").

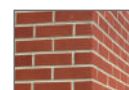

550-HS2 For Ø32mm (1-1/4") and above
Hexagonal shank for 13mm (1/2") chuck, HSS centering tip, total length 180mm (7-5/64").



550-HW2 For Ø32mm (1-1/4") and above
Hexagonal shank for 13mm (1/2") chuck, HW centering tip, total length 180mm (7-5/64").

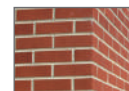

550-DB1 Adapter for easy bore enlargement and plug removal. For use with hole saws with different hexagonal shank sizes. Hexagonal shank 13mm (1/2").



*Bore: achievable when hole saws in use have a 9mm minimum size difference between largest and smallest diameter.



550-HS2XL For Ø32mm (1-1/4") and above.
Long heavy duty, hexagonal shank for 13mm (1/2") chucks, HSS centering tip, total length 320mm (12-19/32").



550-HW2XL Ø32mm (1-1/4") and above.
Long heavy duty, hexagonal shank for 13mm (1/2") chucks, HW centering tip, total length 320mm (12-19/32").

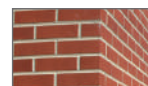

551-HS2XL Ø32mm (1-1/4") and above.
Long heavy duty, hexagonal shank for 13mm (1/2") chucks, HSS centering tip, total length 320mm (12-19/32").



550-EX1 / 550-EX2 Extension for Pilot Bits.
Long heavy duty, hexagonal shank for 13mm (1/2") chucks. Not compatible with XL accessories.



S	mm	L inches	B mm		ORDER NO.
Hexagonal	300	11-13/16	10	10	550-EX1
Hexagonal	300	11-13/16	13	10	550-EX2

550-SDS1 / 550-SDS2 SDS Adapter for Pilot Bits.
SDS shank. Not compatible with XL and EX accessories.

S	mm	L inches	B mm		ORDER NO.
SDS	95	3-3/4	10	10	550-SDS1
SDS	95	3-3/4	13	10	550-SDS2



FASTX4 Multi-Purpose Long Hole Saws

CMT ORANGE TOOLS®

553

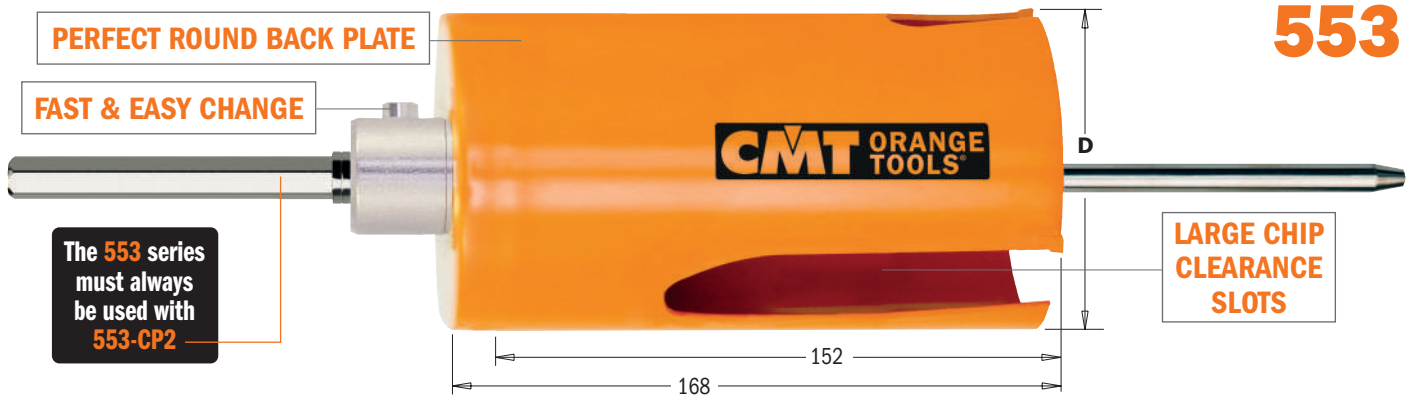

LONG LASTING CONSTRUCTION GRADE CARBIDE.
Specially formulated construction grade carbide means longer lifetime for cutting teeth.



SECURED TOOTH TECHNOLOGY
Thanks to advanced technology, cutting teeth are securely anchored which means they stand up to hard materials. Thanks to advanced technology, cutting teeth are better anchored which means they stand up to hard materials and resist breakage.

10X LONGER LIFE

5X FASTER



553-CP2 Heavy Duty centering pin Ø10mm (25/64").
Hexagonal shank for 13mm (1/2") chucks, total length 330mm (13"). Not compatible with EX and SDS accessories.



mm	D inches	Z	Wood & Mdf RPM	PVC & FIBERGLASS RPM	MASONRY, BRICK RPM	TILE RPM	S		ORDER NO.
32	1-1/4	1	800	600	600	400	Hexagonal	10	553-032 ■
45	1-3/4	2	600	450	450	350	Hexagonal	10	553-045 ■
51	2	2	600	450	450	350	Hexagonal	10	553-051 ■
60	2-3/8	2	500	350	350	300	Hexagonal	10	553-060 ■
65	2-9/16	3	500	350	350	300	Hexagonal	10	553-065 ■
68	2-11/16	3	500	350	350	300	Hexagonal	10	553-068 ■
70	2-3/4	3	500	350	350	300	Hexagonal	10	553-070 ■
76	3	3	500	350	350	300	Hexagonal	10	553-076 ■
80	3-5/32	3	300	250	250	200	Hexagonal	10	553-080 ■
83	3-1/4	3	300	250	250	200	Hexagonal	10	553-083 ■
86	3-3/8	3	300	250	250	200	Hexagonal	10	553-086 ■
92	3-5/8	3	300	250	250	200	Hexagonal	10	553-092 ■
102	4	4	300	250	250	200	Hexagonal	5	553-102 ■
105	4-1/8	4	300	250	250	200	Hexagonal	5	553-105 ■
111	4-3/8	4	200	150	150	120	Hexagonal	5	553-111 ■
114	4-1/2	4	200	150	150	120	Hexagonal	5	553-114 ■
121	4-3/4	4	200	150	150	120	Hexagonal	5	553-121 ■
127	5	5	200	150	150	120	Hexagonal	5	553-127 ■
130	5-1/8	5	200	150	150	120	Hexagonal	5	553-130 ■
133	5-1/4	5	200	150	150	120	Hexagonal	5	553-133 ■
140	5-1/2	5	200	150	150	120	Hexagonal	1	553-140 ■
152	6	5	200	150	150	120	Hexagonal	1	553-152 ■
160	6-5/16	6	200	150	150	120	Hexagonal	1	553-160 ■
177	7	6	200	150	150	120	Hexagonal	1	553-177 ■
190	7-1/2	6	200	150	150	120	Hexagonal	1	553-190 ■
210	8-1/4	7	200	150	150	120	Hexagonal	1	553-210 ■

■ Until stock last

542.100.51 HSS Auger bit Ø10mm (25/64") to pre-drill deep holes in wood and wood-based. Hexagonal shank, total length 200mm (7-7/8").



553-HW10 Tungsten Carbide tipped bit Ø10mm (25/64") for pre-drilling deep holes in masonry. Hexagonal shank, total length 200mm (7-7/8").



PACK QTY. 10 PC



FASTX4 Diamond Dry Hole Saws

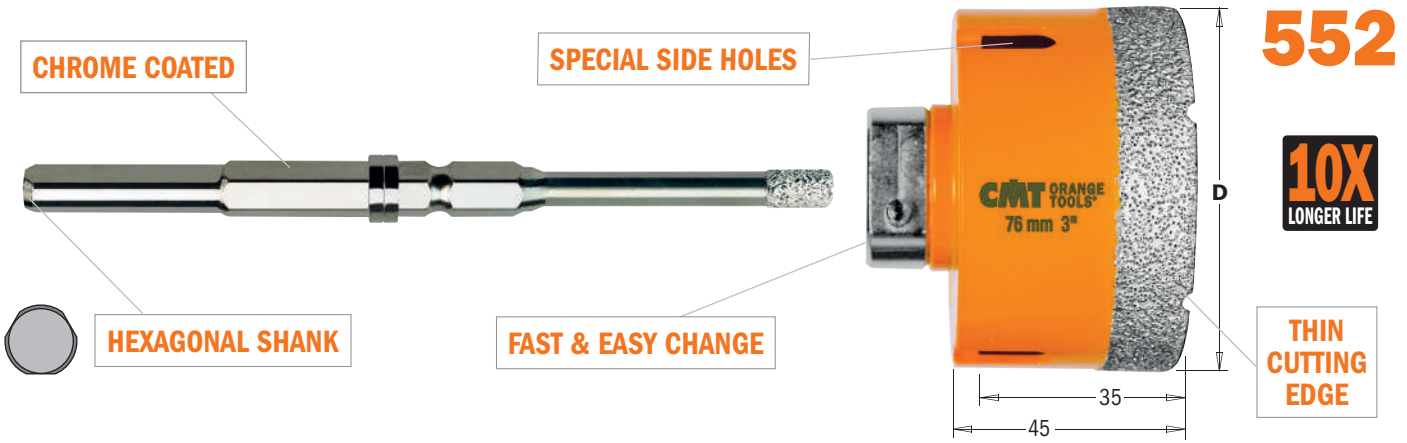

Diamond dry hole saw with continuous edge have been specially developed for professionals that need to drill in extremely hard materials where it is increasingly difficult to drill with conventional hole saws. These hole saws guarantee excellent performance and superior lifetime!



DIAMOND GRIT PREMIUM GRADE

Diamond grit featuring strong cubo-octahedral inclusion-free heat-resistant crystals guarantees fast clean cutting and 10 times longer lifetime.

MATERIALS

- tile (ceramic, gres, etc.)
- hard stone (granite, marble, etc.)
- artificial stone (OKITE®, SILESTONE®, etc.)

mm	D inches	TILES (CERAMIC & GRES) HARD STONE, ARTIFICIAL STONE	S		ORDER NO.
20	13/16	RPM 1500 ~ 4000	Hexagonal	10	552-020 ■
55	2-3/16	RPM 1500 ~ 4000	Hexagonal	10	552-055 ■
73	2-7/8	RPM 1500 ~ 4000	Hexagonal	10	552-073 ■
76	3	RPM 1500 ~ 4000	Hexagonal	10	552-076 ■
111	4-3/8	RPM 1500 ~ 4000	Hexagonal	5	552-111 ■

■ Until stock last



552-DD1 For diamond dry hole saws ≤ **Ø30mm** (1-3/16"). Hexagonal shank for **10mm** (25/64") chuck, 8mm diamond centering tip, total length 143mm (5-5/8").

PACK QTY.
10 PC



552-DD2 For diamond dry hole saws ≥ **Ø32mm** (1-1/4"). Hexagonal shank for **13mm** (1/2") chuck, 10mm diamond centering tip, total length 143mm (5-5/8").



552-WAX Cooling & lubricating wax

PACK QTY. 10 pcs.

TIPS FOR USE: While drilling, the wax will melt away (eliminated along with drilling waste). This facilitates cooling and lubrication. Replenish wax after every use (when still warm) to extend lifetime. **Jar 20ml. (0.68oz)**

Granite and Marble

**NO WATER,
LESS MESS!**

Diamond dry step-by-step

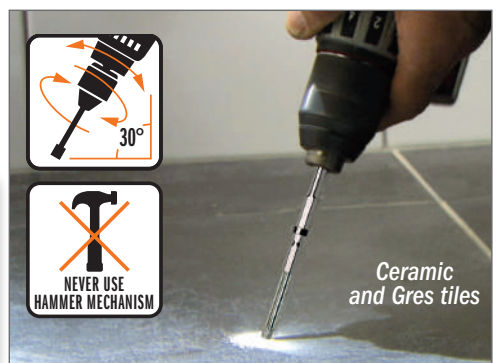

Never use the hammer mechanism with these hole saws. We recommend the use of a high speed drill (minimum 14V). For best results, use the centering tip to pre-bore. Use of the centering tip reduces the risk of slipping.



Ceramic and Gres tiles

Diamond Dry Hole Saws



552-0

mm	D inches	I mm	L mm	TILES (CERAMIC & GRES) HARD STONE, ARTIFICIAL STONE	S		ORDER NO.
5	13/64	30	68	RPM 2200 ~ 4000	Hexagonal	10	552-005
6	1/4	30	68	RPM 2200 ~ 4000	Hexagonal	10	552-006
8	5/16	40	80	RPM 2200 ~ 4000	Hexagonal	10	552-008
10	3/8	40	80	RPM 2200 ~ 4000	Hexagonal	10	552-010
12	15/32	40	80	RPM 2200 ~ 4000	Hexagonal	10	552-012
14	9/16	40	80	RPM 2200 ~ 4000	Hexagonal	10	552-014
16	5/8	40	80	RPM 2200 ~ 4000	Hexagonal	10	552-016



RPM 2200 ~ 4000

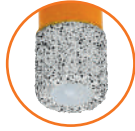

Filled with cooling wax
552-WAX



552-WAX Cooling & Lubricating Wax

PACK QTY. 10 pcs.

TIPS FOR USE: While drilling, the wax will melt away (eliminated along with drilling waste). This facilitates cooling and lubrication. Replenish wax after every use (when still warm) to extend lifetime. Jar 20ml. (0.68oz)



552-001-05

5 PIECE HOLE SAW SET

- 552-005 Ø5mm
- 552-006 Ø6mm
- 552-008 Ø8mm
- 552-010 Ø10mm
- 552-012 Ø12mm

PACK QTY. 10 pcs.

552-GUIDE

Drill Guide with Suction Cups - 7 holes
Ø4 - 5 - 6 - 7 - 8 - 10 - 12mm
Ø5/32" - 3/16" - 1/4" - 9/32" - 5/16" - 3/8" - 1/2"

PACK QTY. 10 pcs.



552 Recommendations for use

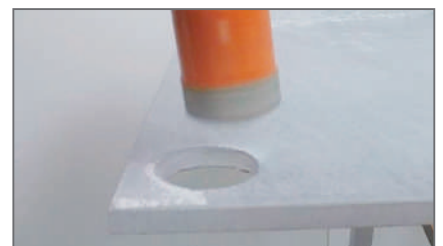
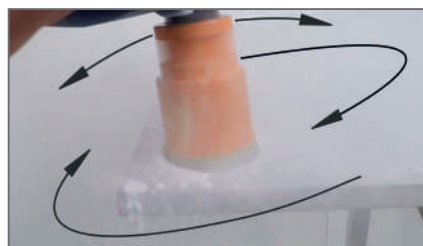
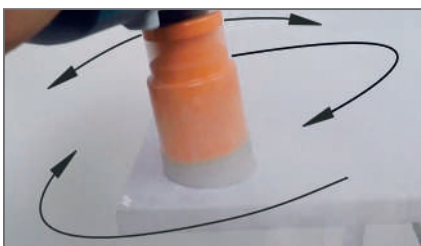
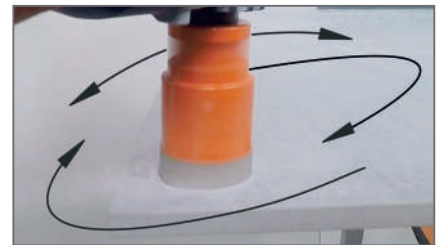
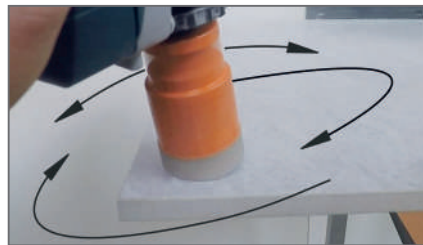
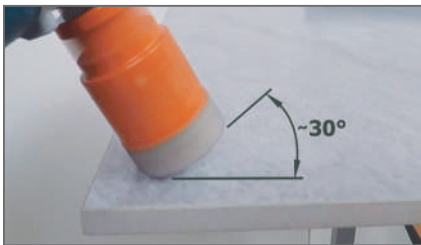



M14



19mm
3/4"

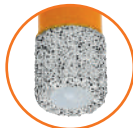

552-5

	D		I	L	TILES (CERAMIC & GRES) HARD STONE, ARTIFICIAL STONE	S		ORDER NO.
	mm	inches	mm	mm				
	5	13/64	35	60	MAX RPM 14000	M14	10	552-505
	6	1/4	35	60	MAX RPM 14000	M14	10	552-506
	8	5/16	35	60	MAX RPM 14000	M14	10	552-508
	10	3/8	35	60	MAX RPM 14000	M14	10	552-510
	12	1/2	35	60	MAX RPM 14000	M14	10	552-512
	14	9/16	35	60	MAX RPM 14000	M14	10	552-514
	16	5/8	35	60	MAX RPM 14000	M14	5	552-516
	18	45/64	35	60	MAX RPM 14000	M14	5	552-518
	20	13/16	35	60	MAX RPM 14000	M14	5	552-520
	25	1	40	60	MAX RPM 14000	M14	5	552-525
	28	1-1/8	40	60	MAX RPM 14000	M14	5	552-528
	35	1-3/8	40	60	MAX RPM 14000	M14	5	552-535
	43	1-3/4	40	60	MAX RPM 14000	M14	5	552-543
	51	2	40	60	MAX RPM 14000	M14	5	552-551
	55	2-3/16	40	60	MAX RPM 14000	M14	5	552-555
	68	2-11/16	40	60	MAX RPM 14000	M14	5	552-568

Filled with cooling wax
552-WAX
(MAX Ø16mm)



≥ Ø18mm



552-EX14
Hexagonal adapter for electric drills (M14)

PACK QTY. 10 pcs.



552-501-06 6 PIECE HOLE SAW SET

- 552-506 Ø6mm
- 552-508 Ø8mm
- 552-510 Ø10mm
- 552-512 Ø12mm
- 552-GUIDE
- 552-EX14

PACK QTY. 10 pcs.



Join us on YouTube
YouTube



Turn on drill to start tool rotation. Begin drilling at a 30° angle – this is the angle measured between the hole saw and the working surface. Cutting at an angle will prevent tool from slipping and facilitate precision centering. To improve stability during operation, use the working surface as leverage by resting the drill against it.

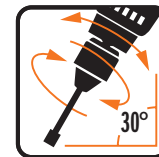

Continue the cut vertically, accompanying the tool in an orbital motion. This will favor better cooling and chip evacuation. (If you are using a guide, begin the cut vertically, then lift the guide and continue cutting in an orbital motion).

Remember, the hole saw is not a drill bit. Attempting to bore holes perpendicular to the work surface on a frequent basis will drastically reduce tool lifespan. Using water as a cooling agent may help extend the life of the hole saw. Never use the hammer mechanism!

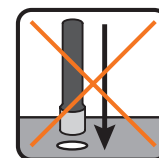

Diamond Dry Special Bits for Angle Grinder

new

CMT ORANGE TOOLS®

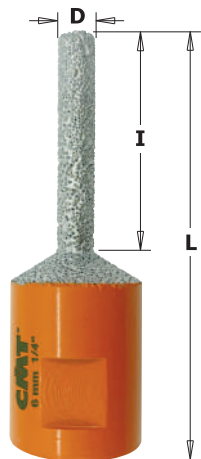

552-506M



552-520M

M14



19mm
3/4"

552-M

mm	D inches	I mm	L mm	S		ORDER NO.
6	1/4	35	65	M14	5	552-506M
20	13/16	50	65	M14	5	552-520M

MATERIALS

- tile (ceramic, gres, etc.)
- hard stone (granite, marble, etc.)
- artificial stone (OKITE®, SILESTONE®, etc.)



APPLICATION: for Milling, Enlarging, Shaping, Countersinking on Existing Holes

TIPS: it can also be used to create lateral semicircular recesses (for cables, pipes, etc.)

Diamond Dry Special Bits for Angle Grinder

new

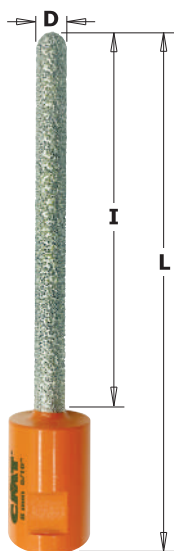

M14



19mm
3/4"

552-508M

mm	D inches	I mm	L mm	S		ORDER NO.
8	5/16	100	130	M14	5	552-508M

MATERIALS

- tile (ceramic, gres, etc.)
- hard stone (granite, marble, etc.)
- artificial stone (OKITE®, SILESTONE®, etc.)



APPLICATION: for Raking out Mortar Joint and for Milling, Enlarging and Shaping Existing Holes

TIPS: suitable for raking out mortar joints and removing bricks.

Diamond Dry Special Bits for Angle Grinder

new

CMT ORANGE TOOLS®

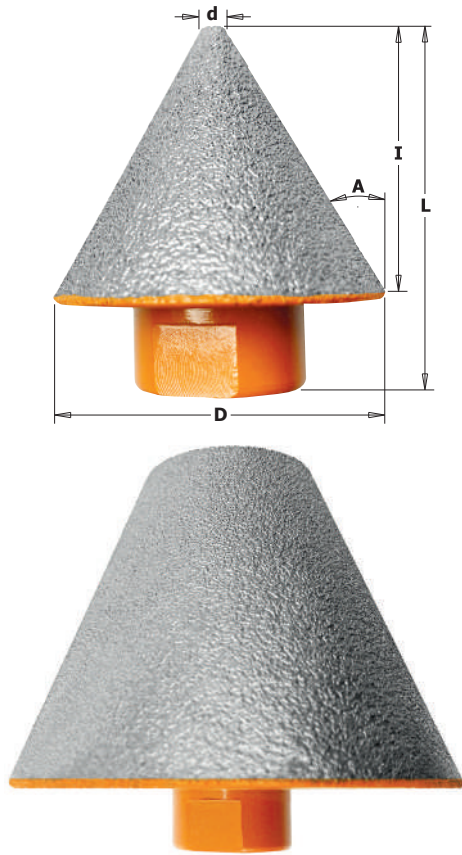

M14



552-CS

mm	d	inches	mm	D	inches	I	A	S	BOX	ORDER NO.
5		13/64	35		1-3/8	30	65°	M14	5	552-535CS
30		1-3/16	70		2-3/4	50	45°	M14	5	552-570CS

MATERIALS

- tile (ceramic, gres, etc.)
- hard stone (granite, marble, etc.)
- artificial stone (OKITE®, SILESTONE®, etc.)



APPLICATION: for Countersinking on Existing Holes

Diamond Dry Wheels for Angle Grinder

new

552-115 CURVED

mm	D	inches	mm	B	inches	GRIT	BOX	ORDER NO.
115		4-1/2	22,2		7/8	medium-fine	5	552-115-01
115		4-1/2	22,2		7/8	coarse	5	552-115-02



CURVED

MATERIALS

- tile (ceramic, gres, etc.)
- hard stone (granite, marble, etc.)
- artificial stone (OKITE®, SILESTONE®, etc.)



APPLICATION: for Smoothing, Trimming, Chamfering

552-115 FLAT

mm	D	inches	S	GRIT	BOX	ORDER NO.
115		4-1/2	M14	medium-fine	5	552-115-03
115		4-1/2	M14	coarse	5	552-115-04

M14



FLAT

POWER TOOLS, JIGS & ACCESSORIES

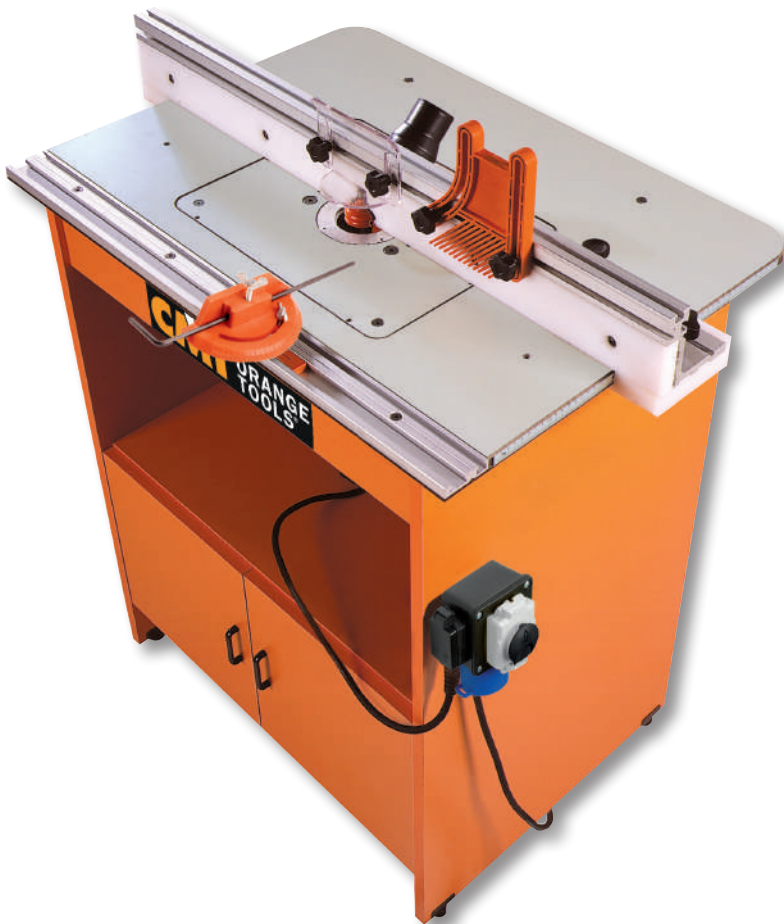

PRODUCTS	PAGE
Routers & Trimmer	378-380
Oscillating Multi-Tools	381
Router Tables	382-383
Small Stock Holder & Tabletop Accessories	384
Pocket-Pro Joinery System	385
Professional Straight Edge Clamps	386
Adjustable Precision Router Dado Jig	387
Universal Dovetail Jig	388-389
Eclipse & Circle Cutting Jig	390
Kitchen Worktop Jig	391
Universal Hinges Boring Systems	392-394
Bench Block Set	394
Inlay & Template Guide Kit	395
Universal Boring Template and Jig	396-397
3D Router Carver System	398-400
Organizer	400
Tool Cleanear & Lubricant	401
Flexible Templates for Routing	402
Contour Duplicator Gauge	403
Adjustable Corner Frame Clamps	403
Digital Height Gauge	404
Digital Moisture Meter	404
Digital Angle Gauge & Finder	405
Torque Screwdriver & Wrench	406
Edge Banding Jigs	407
Bowl & Tray System	408
Diamond Whetstones	409
Glooves	410
CMT Professional Tool Bag	410
Carpenter Pencil & Ink Pen	410
Deep Hole Mechanical Marker	411



1000W Professional Router



CMT8E



QUICK BRUSH REPLACEMENT
Change worn brushes quickly and easily.

SAFETY SWITCH SHUTTER
Locks to prevent accidental power on.

SIDE AIR VENTS
reduces dust intake into the motor casing when mounted upside-down in a router table.

ELECTRONIC SPEED CONTROL & SOFT START
From 8.000 - 20.000 RPM.

FULLY ENCLOSED GUARDING
provides maximum protection around cutting zone.

MULTI-FUNCTION FENCE
provides excellent control for hand-held use and circle cutting.

QUICK FIT PINS
for fast setup and removal from fence.

TECHNICAL SPECIFICATIONS

- Power..... 1000W
- Input..... 220/240V (50/60Hz)
- No load speed 8.000-20.000 RPM
- Plunge range..... 0-59mm
- Base plate hole Ø77mm
- Collet diameter range..... Ø6~12,7mm
- Tool weight..... 3,8 Kg

CONTENTS

- Extended baseplate with adjustable fence
- Fine micrometric adjustment knob.
- Dust extraction outlet
- Easy adjustment
- Wrench for easy cutter change

- Ø8mm (796.680.00) and Ø12mm (796.720.00) collets
- 1 year warranty
- Instruction manual

Worldwide Technical Assistance

DESCRIPTION	ORDER NO.
1KW Professional Router	CMT8E

Optional

Clamping nuts and collets for CMT8E and CMT7E

DIAMETER	ORDER NO.
D = 6mm	796.660.00
D = 6,35mm	796.664.00
D = 8mm	796.680.00
D = 10mm	796.700.00
D = 12mm	796.720.00
D = 12,7mm	796.727.00



Optional



DESCRIPTION	ORDER NO.
Prebored plastic router plate for CMT7E and CMT8E	CMT300-SB
Guide bush Ø30mm	899.007.00

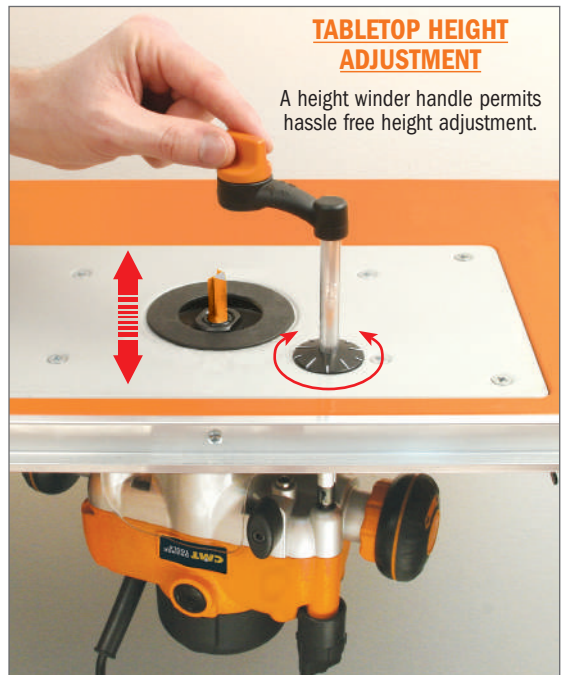

TABLETOP HEIGHT ADJUSTMENT

A height winder handle permits hassle free height adjustment.

2400W Professional Router - Updated version



CMT7E

NO VOLTAGE RELEASE (NVR) SAFETY SYSTEM

prevents the motor from automatically restarting after a power interruption.

new

ELECTRONIC SPEED CONTROL & SOFT START

From 8.000 - 21.000 RPM

REMOVABLE PLUNGE SPRING

for easy bit adjustment when table mounted.

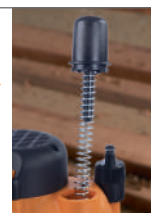

QUICK BRUSH REPLACEMENT

change worn brushes quickly and easily.



Check out **CMT7E** on



QUICK SWITCH FROM FREE PLUNGE TO WINDER HANDLE ADJUSTMENT

Simply press or release button.



ON/OFF POWER SWITCH

Locks to prevent accidental power on.

SIDE AIR VENTS

reduces dust intake into the motor casing when mounted upside-down in a router table.

3 TURRET STOPS

with direct reading scales (mm) for precise preset cut depths.



SAFETY GUARDS

provides maximum protection around cutting zone.

MULTI-FUNCTION FENCE

provides excellent control for hand-held use and circle cutting.

QUICK FIT KNOBS

for fast setup and removal from fence.

TECHNICAL SPECIFICATIONS

- Power 2400W
- Input 220/240V (50/60Hz)
- No load speed 8.000-21.000 RPM
- Plunge range 0-68mm
- Base plate hole Ø79mm
- Collet diameter range Ø6~12,7mm
- Tool weight 6,5 Kg



DUAL MODE

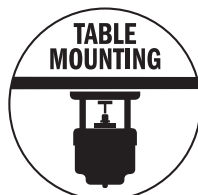

CONTENTS

- CMT7E Precision Router
- Multi-Function Fence (extended baseplate)
- Table Height Winder
- Collet Spanner
- Ø8 & Ø12mm collets
- 4 Screws (1/4 UNC)
- NVR Bypass Key
- 1 Year Warranty
- Instructions manual (10 languages)

DESCRIPTION	ORDER NO.
2.4KW Professional Router	CMT7E

TABLETOP HEIGHT ADJUSTMENT

A height winder handle permits hassle free height adjustment.

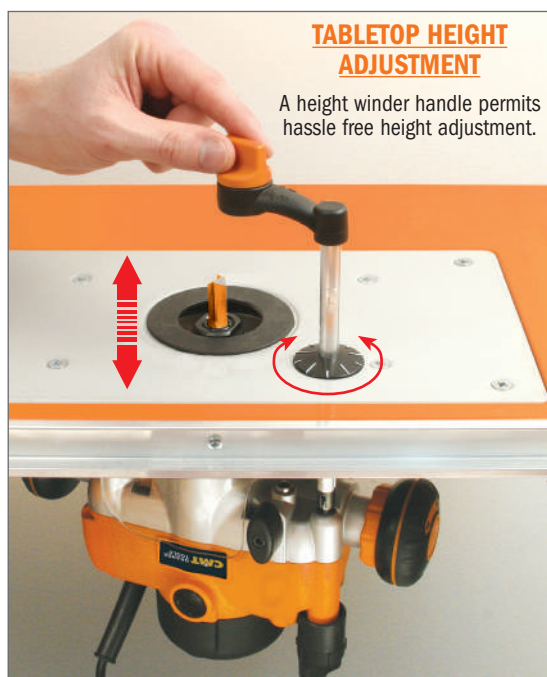

Optional

Clamping nuts and collets for CMT8E and CMT7E

DIAMETER	ORDER NO.
D = 6mm	796.660.00
D = 6,35mm	796.664.00
D = 8mm	796.680.00
D = 10mm	796.700.00
D = 12mm	796.720.00
D = 12,7mm	796.727.00



Optional

DESCRIPTION	ORDER NO.
Prebored plastic router plate for CMT7E and CMT8E	CMT300-SB
Guide bush Ø30mm	899.007.00

550W Professional Trimmer

CMT10

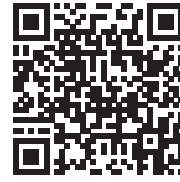

Watch the video on
YouTube

QUICK BRUSH REPLACEMENT

change worn brushes quickly and easily.

ERGONOMIC DESIGN

Better control during one-handed operation.

QUICK-CLAMP SYSTEM

Easily remove motor from the base.

BASE PLATE

FAST TOOL REPLACEMENT



DESCRIPTION		ORDER NO.
550W Professional Trimmer	8	CMT10

TECHNICAL SPECIFICATIONS:

- Power..... 550 Watt
- Input 220/230V (50/60Hz)
- No load speed 32.000 RPM
- Plunge stroke 0-24mm
- Base plate hole Ø34mm
- Collet diameter..... Ø6-8mm
- Tool weight..... 1,6 Kg

Standard Equipment

- Extended baseplate with adjustable fence
- Trimmer guide
- Guide bush
- 2 wrenches for easy cutter replacement (12 and 17mm)
- Ø6mm, Ø6,35mm and Ø8mm collet
- 1 year warranty
- Instruction manual

Worldwide Technical Assistance

Standard Equipment



Aluminium-embossed scale for accurate setting of the desired routing depth.

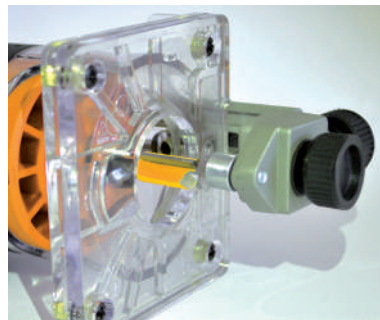

Trimmer guide with DELRIN® roller prevents marring.

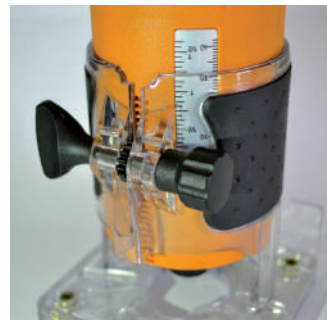

Fine depth adjustment.



CMT10-54
Ø10mm guide bush

Spare parts



CMT10-16A
Dust guard & base plate



CMT10-17
Clamping nut



CMT10-18 Collet Ø6mm
CMT10-18A Collet Ø6,35mm
CMT10-18B Collet Ø8mm

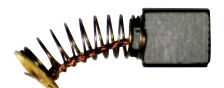

CMT10-30
Pair of carbon brushes

CMT11

FAST LOCK



SPEED CONTROL 1-6

MULTI MATERIALS & APPLICATIONS:



- GRINDING
- SAWING
- JOINT OPENING
- PLASTIC CUTTING
- CARPET REMOVAL
- PLUNGE CUTTING
- WOOD CUTTING
- CUTTING LAMINATE SHEETS
- TUBE LENGTH TRIMMING
- NAIL CUTTING



FAST LOCK



Included



HANDLE

VACUUM HOSE

Standard Equipment

- 1 x Oscillating Multi-tool
- 1 x handle
- 1 x vacuum hose
- 1 x manual
- 1 x plastic carry case

TECHNICAL SPECIFICATIONS:

- Power.....300 Watt
- Input.....220/230V (50/60Hz)
- No load speed11.000~21.000 RPM
- aw (vibration).....19,7m/s2 - K=1,5m/s2
- Tool weight.....1,5 Kg

Worldwide Technical Assistance

DESCRIPTION		ORDER NO.
300W Oscillating Multi-Tools	5	CMT11



Professional Router Table

CMT ORANGE TOOLS®

999.110.00

CE Compliant

CMT7E+PRO

Our quality bits have been designed for you, the professional craftsman, to allow you to confidently work at your best. CMT now offers even more possibilities with our professional router table: the perfect place to combine your skills and CMT quality. The professional router table system has a strong and sturdy MDF laminate work surface measuring 80x60x2,5cm for easy mobility when working. This free standing table sits at a comfortable height of 90cm on solid high gauge steel legs and weighs 26,5 Kg. The plate is already pre-bored for CMT routers **CMT7E** but is adaptable to all brands and models of routers on the market. Plate can also fit any router bit up to 98mm in diameter. Choose from our wide range of bits, including multi profile and molding bits or even kitchen bit set. Work easily and safely on this table!



Router table dimensions:
80x60x90cm. - 26,5 Kg.

Optional

999.100.11

Electric Safety Switch
(Mandatory for CE Compliance)



DESCRIPTION	ORDER NO.
Professional Router Table System	999.110.00
999.110.00 + CMT7E + 999.100.11 (CE Compliant: Only when purchase together)	CMT7E+PRO
Spare parts:	
CMT7E Prebored Plate (306x229x8mm) with 2 reduction rings Ø32-66mm	999.110.33
LEXAN® Safety Shield	999.110.06
Standing Spring Press	999.110.08
Moulded ABS Featherboard	999.110.09
Mitre Gauge	999.110.10
Optional:	
Universal Plate (unbored for non-CMT routers) with 2 reduction rings Ø32-66mm (306x229x8mm)	999.110.03
CMT8E Prebored Plate with 2 reduction rings Ø32-66mm (306x229x8mm)	999.110.34
Electric Safety Switch (Mandatory for CE Compliance)	999.100.11
4 Screws for CMT7E assembly on Professional Router Table System	990.467.00

Industrio Routing System

CMT has further improved the Industrio Routing System into an impressive instrument featuring new accessories such as a phenolic worktop, integrated aluminum scales and an improved fence.

CMT ORANGE TOOLS®

999.500.01

Check out
Industrio Routing System on
YouTube

CE Compliant

CMT7E+IND

999.501.18

CMT7E Prebored Plate & Aluminium Rings
Ø103-69,5mm.



999.501.08

Mitre Gauge

999.502.10

Central section of the fence is removable and shapeable.



999.501.06

Dual and post-guard makes freehand work safer.



999.501.07

Moulded ABS featherboard.
Setup on table and in fence slots.

999.502.34

Router Centering Device
(8-12mm) for the drilling
of housing bores
with non-CMT routers.



999.500.01 includes: (also sold separately)

• 999.501.09 Phenolic Worktop

Boasting a phenolic worktop is 20 mm thick and is far sturdier and more resistant to wear and warping than regular melamine surfaces. Features aluminum scales on both ends for quick and easy fence setup. Fast and easy bit change, CMT's useful bent wrench 991.006.00 (optional) allows you to replace the bits from above quickly and easily. CMT7E Prebored plate: 298x374x12 mm (11-3/4" x 14-3/4" x 15/32"). Weight: 15 Kg.

Includes: 999.501.18

• 999.501.10 Adjustable Aluminum Guide Fence

To be used as a traditional fixed or pivoting fence. Quick adjusting clamps on both ends make adjustments a breeze. Features a sub-fence made of high-density white plastic, with a central section both removable and shapeable, guaranteeing an ultra-smooth feeding surface. Weight: 8.5 Kg.

Includes: 999.501.06, 999.502.10, 999.502.34

• 999.501.03 Orange Sturdy Melamine Cabinet

Made of 20mm thick melamine, this cabinet is easy to assemble. Weight: 32.5 Kg.

• 999.501.07 Moulded ABS Featherboard

• 999.501.08 Mitre Gauge

Router table dimensions:
79x59x93cm. - 55 Kg.

Optional

999.100.11

Electric Safety Switch
(Mandatory for CE Compliance)

Optional

Bent wrenches for bit
replacement.

17mm**991.005.00**

21mm**991.002.00**

22,2mm**991.004.00**

23,8mm**991.003.00**

24mm991.006.00*

28,6mm**991.001.00**

*For CMT7E and CMT8E routers

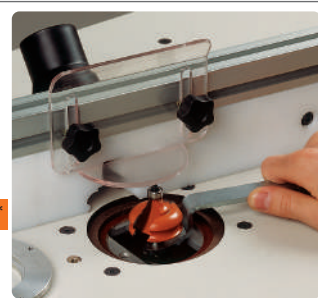

DESCRIPTION

ORDER NO.

Industrio Routing System (with prebored plate for CMT7E)

999.500.01

999.500.01 + CMT7E + 999.100.11 + Additional 999.501.07 (CE Compliant: Only when purchase together)

CMT7E+IND

Optional:

Universal Plate (unbored for non-CMT routers) with Ø103-69,5mm aluminium rings

999.501.26

CMT8E Prebored Plate with Ø103-69,5mm aluminium rings

999.501.27

Aluminium Reduction Rings (pair) Ø103-69,5mm

999.501.05N

Electric Safety Switch (Mandatory for CE Compliance)

999.100.11

4 Screws for CMT7E assembly on Industrio Routing System

990.467.00

Small Stock Holder

By far, handling small stock on your router table is probably one of the most difficult challenges any professional woodworker has to face! Keeping all ten fingers attached to your hands is definitely a priority.

This is why the CMT Small Stock Holder is an absolute necessity in the workshop! It safely ensures proper stabilization of smaller work pieces throughout the routing process. The handle grips fitted with comfy silicone inserts keep fingers and hands a safe distance from the blade while the anti-slip lining on both the center and right side base prevents slippage and ensures your work-piece stays put!

Fully adjustable and easy to control, the CMT Small Stock Holder can manage small stock up to **216mm. (8-1/2")** in width. The perfect little jig for detail-oriented jobs!

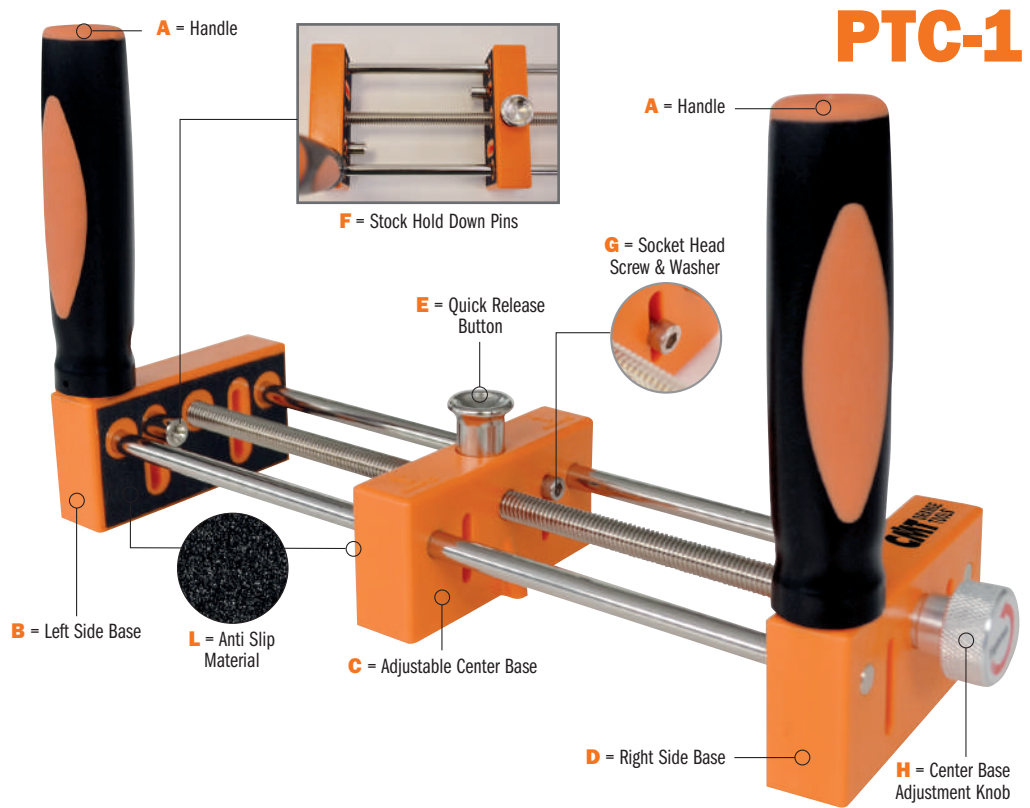

PTC-1

DESCRIPTION	ORDER NO.
Small Stock Holder	PTC-1



1. Lie the Small Stock Holder flat on the work surface. Slide the Hold Down Pins [F] to the top of the slotted holes. Insert the small stock piece between the Adjustable Centre [C] and Left-Side Bases [B]. The end of your small stock piece should lie flat and snugly up against the Left-Side Base. The end must also extend outwards in front of the Small Stock Holder a minimum distance of half the diameter of the router bit in use.



2. Press the Quick Release Button [E]. Slide the Adjustable Centre Base [C] over until it fits snugly against the small stock piece. Release the Quick Release Button. In the image, a "sacrificial piece" is being used to prevent "tear-out". Loosen Hold Down Pins [F] with the Hex Wrench provided. Slide Hold Down Pins down until resting firmly against the small stock piece. Tighten pins with Hex Wrench. Rotate Centre Base Knob [H] to further secure your small stock piece.

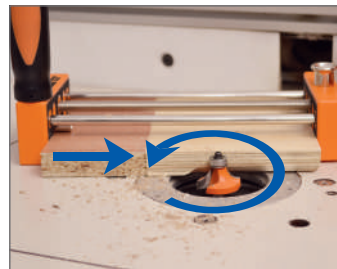

3. Adjust the height of your router bit. When you're ready, power on your router. Take hold of the Small Stock Holder Handles [A], slowly feed your small stock piece into the router opposite to the router bit rotation and always in contact with the router bit bearing guide. When finished routing, press the Quick Release Button [E] and slide the Adjustable Centre Base [C] over so you can remove the small stock piece.

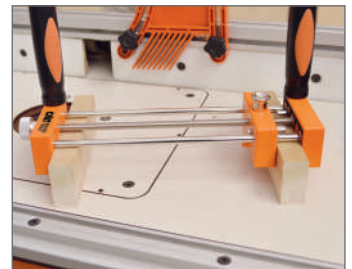

4. Need to rout stock thicker than the Small Stock Holder? Follow setup instructions carefully. Create an "outrigger"- cut a piece of stock, which will act as a stabilizer, the same thickness as the piece you are working on. Attach the "outrigger" securely to the Right-Side Base [D] using pan-head screws (not included) that will fit through the slotted holes. In this way, your work piece and the Small Stock Holder will remain stable during the routing process.

Tabletop Accessories

new



999.110.42
Push block

999.110.41
Push stick

999

DESCRIPTION	ORDER NO.
Push stick	999.110.41
Push block	999.110.42



Pocket-Pro Joinery System



PPJ-002

For fast, easy and accurate cabinet & furniture construction. Designed by CMT and professional cabinetmakers, this new system allows you to make rock-solid pocket hole joints in stock 12,7mm (1/2") to 41,3mm (1-5/8") thick with unprecedented speed and accuracy.

The heart of the Pocket-Pro System is our unique moulded jig, which features hardened drill bushings and an interlocking two-piece design. Sliding the jig up or down enables you to adjust the stock thickness in preset 1,6mm (1/16") increments without test joints or measurements! If you have used other pocket hole jigs you will be familiar with many joint applications, but you will benefit from many Pocket-Pro System advantages.

For example:

- some jigs require adding or removing various parts of the jig to join different stock thicknesses. With the Pocket-Pro System you simply have to adjust the interlocking jig up or down for the full range of joints 12,7mm (1/2") to 41,3mm (1-5/8") thick;
- other jigs require frequent repositioning of the depth stop collar for different joint styles. CMT's Pocket-Pro Joinery System allows you to make most of the adjustments leaving the stop collar in the same position of the drill bit;
- plus, with CMT's Pocket-Pro System you can quickly adjust the location of the pocket in relation to the end of your workpiece to create a stronger joint by using longer screws, or to leave more "meat" in the joint.

Check out the Pocket-Pro Joinery System today. Easy enough for beginners and accurate enough for professional workers, it is the world's most versatile pocket hole jig.



DESCRIPTION OPTIONAL	ORDER NO.
500 fine screws L=31,7mm (1-1/4")	990.101X500
500 coarse screws L=31,7mm (1-1/4")	990.102X500
500 fine screws L=38,1mm (1-1/2")	990.103X500
500 coarse screws L=38,1mm (1-1/2")	990.104X500
Face clamp swivel pad	999.505.06
L=76mm (3") square drive screwdriver bit	999.505.07
Phenolic insert plate (for Pocket-Pro)	999.505.04

DESCRIPTION	ORDER NO.
Pocket-Pro Joinery System set	PPJ-002
Set contains:	
Pocket-Pro main parts	999.505.10
Toggle clamp	999.505.05
Ø9,5mm (3/8") step drill bit	515.001.51
Ø9,5mm (3/8") depth collar for step drill bit	541.095.00
L=152mm (6") Square drive screw driver bit	999.505.08
Masterpack 30 screw L=31,7mm (1-1/4")	990.101X30



Watch the video on
YouTube

ENJOY EASY POCKET HOLE JOINERY!

BUILD ALMOST ANYTHING!

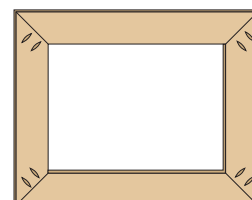
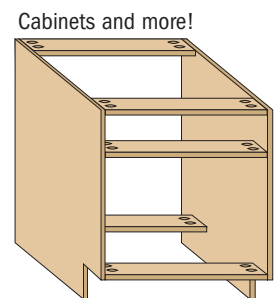
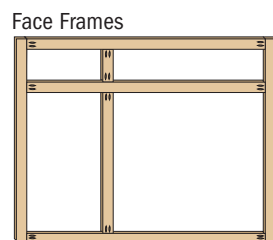
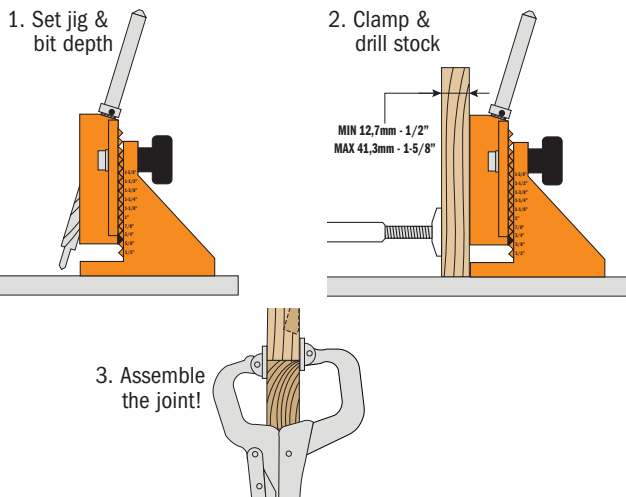

Picture Frames

Professional Straight Edge Clamps

Used as a fence for your bandsaw, drill press or even as an auxiliary fence on your router table or table saw, CMT's professional straight edge clamps represent a two-in-one tool, allowing you to either use them as an edge guide, or to easily clamp your boards or any object for woodworking. Available in different sizes. Here are the main features:

- Made of extruded aluminium for easy carriage and enhanced durability.
- Light, yet more rigid than any other clamps on the market.
- Measuring scales, low-profile jaws, built-in T-tracks on the top allowing the use of accessories or jigs.
- Either single or back-to-back clamps.

Low-profile clamps allow for accurate cuts, dados and grooves. In addition they properly work as an auxiliary fence on your drill press or router table. Sturdy jaws hold your workpiece to the full length of the clamp without any side-to-side play. Back-to-back clamps with the suitable accessories also let you manage your woodworking operations with a lot of versatility. Adjustable scale and two T-tracks allow you to use many accessories.

DESCRIPTION	ORDER NO.
Professional Straight Edge Clamp 610mm	PGC-24
Professional Straight Edge Clamp 915mm	PGC-36
Professional Straight Edge Clamp 1270mm	PGC-50

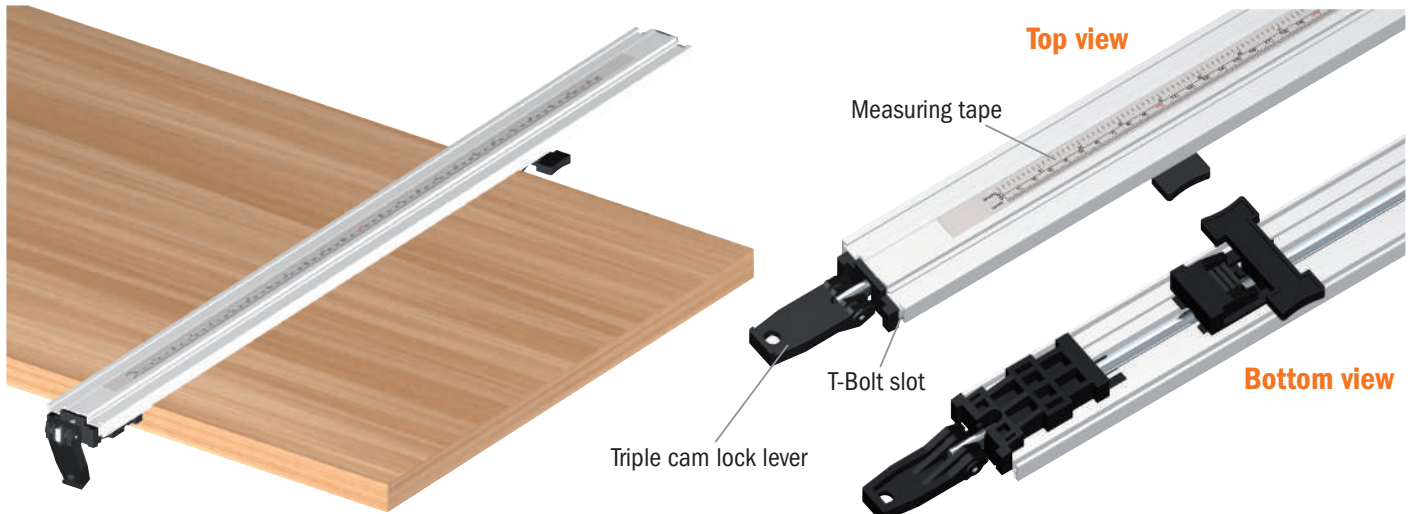

Back-to-Back Connectors for Straight Edge Clamps (optional)

Lay two more straight edge clamps on the back of the other pair of straight edge clamps and secure them by using your back-to-back connectors. Fasten the bottom jaw pads to the table top and clamp wood with the top jaw pads. Thanks to the low profile jaws your work surface is never obstructed. The back-to-back straight edge clamps can also be taken apart for making two separate clamps.

DESCRIPTION	ORDER NO.
Back to Back Connectors for straight edge clamps (8-Pieces)	PGC-B2B

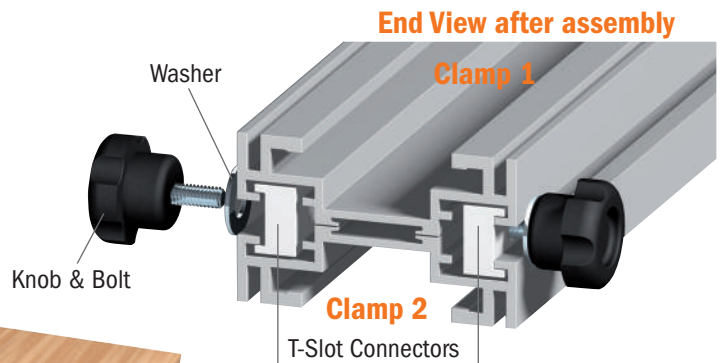

Adjustable Precision Router Dado Jig



PGD-1

The perfect tool for crafting grooves, dadoes, and joints. Easy to use and fully adjustable. You can create dadoes of any size using the same router by simply increasing the number of passes you make. Sturdy construction built to last. Smooth rolling steel rollers are ideal for easy maneuverability and stress-free handling. Compatible with almost any router equipped with 1-3/16" (30mm) bushings or by using the Bushing Template Guide included. (bore baseplate sold separately). Guarantees clean precise dadoes.

FITS THE MOST POPULAR ROUTERS

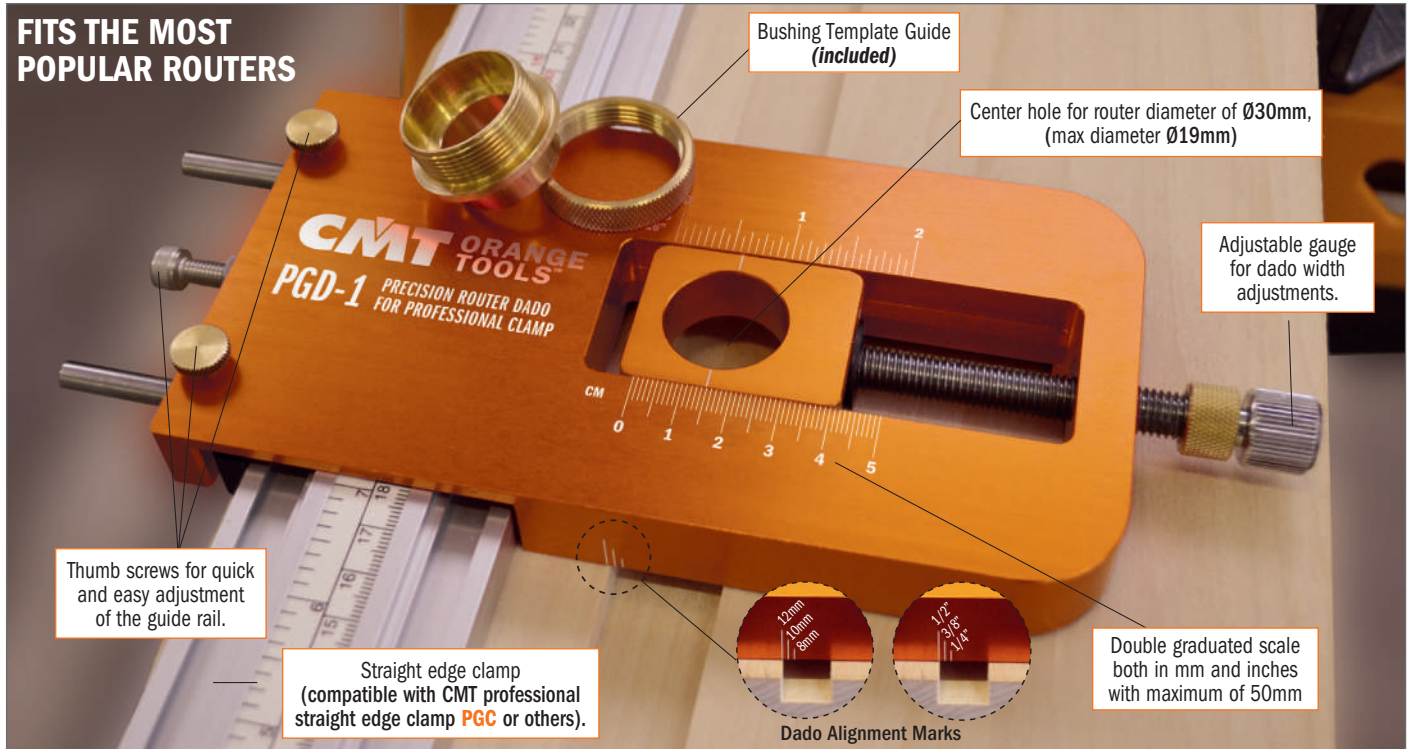

Prepare your router: Install the guide bushing rings into the bore baseplate and then attach it as the base for your router. Select and insert your router bit. Prepare the Adjustable Guide Rail & Straight Edge Clamp: Position both the adjustable straight edge clamp and then the adjustable precision router dado jig onto your workpiece. Then using the adjustable thumb screws, secure it. Once assembled, ensure that the adjustable precision dado jig slides freely.



Insert your router into the center hole of the adjustable precision router dado jig.

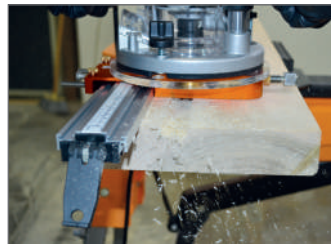

Set your cutting depth by raising or lowering the bit until desired depth is reached. Determine the starting point of the cut you wish to make by using the Dado Alignment Marks on the long sides (width) of the Adjustable Precision Router Dado Jig which indicates the outside edge of the dado cut closest to the straight edge clamp (12-10-8mm front, 1/2", 3/8", 1/4" back).



Holding onto your router in position, power on and begin making the cut by pushing forward and back on the straight edge clamp using the precision router dado jig as a guide. Makes impeccable grooves and dadoes along the length of your workpiece.



For creating dadoes that exceed router width, using the adjustable gauge, simply select the desired width on the graduated scale.

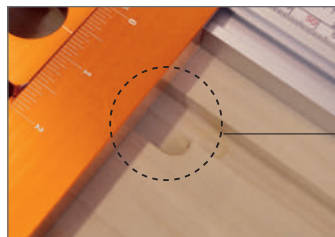

Make as many passes necessary to obtain the desired dado width.

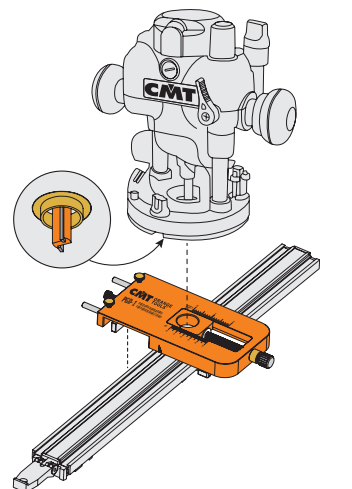
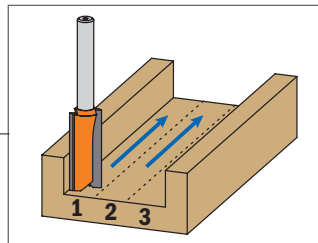

RECOMMENDED* (not included)

Universal Router Base

899.000.01 or

899.000.02 Prebored base for CMT7E/CMT8E

*Not required for routers with 30mm (1-3/16") bushing guide

RECOMMENDED (not included)

PGC Straight Edge Clamp with graduated scale (pag. 386)

DESCRIPTION	BOXES	ORDER NO.
Adjustable Precision Router Dado Jig	10	PGD-1

CMT300

305mm max length
11~25mm joint thickness

Universal Dovetail Jig

Dovetail joints give a touch of craftsmanship to your work, but many woodworkers avoid these joints, because of their apparent complexity. CMT's new 305mm dovetail jig is the fast easy solution! Thanks to precise templates, permanent stops and easy adjustments, we have taken the "tinkering" out of dovetail joinery. Simply clamp your workpiece in with the edges against the factory-set stops, set your bit depth and then you are ready to rout. Rest assured, we haven't cut corners on quality either. This jig features a rugged steel body, templates, stops and clamping bars that together produce perfect long-lasting joints for all your woodworking needs. The jig accepts stock from 11mm to 25mm in thickness and is capable of crafting a variety of joints with the available templates. The jig comes with a template for 12.7mm half blind joints as well as a template guide. Optional templates are available for through dovetail and box joints.

Check out **CMT300** on



**CLOSED SECTION
STEEL CLAMPING BAR**

RUGGED STEEL TEMPLATE



**FACTORY-PRESET
STOP**

**STRONG STEEL BODY
SOLID SUPPORT**

**EASY-GRIP
CLAMPING KNOB**

Standard equipment
 · Standard Ø12,7mm silver blind template **CMT300-T128**
 · Ø15,8x4mm template guide **899.005.00**

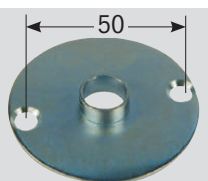

DESCRIPTION	ORDER NO.
Universal Dovetail Jig	CMT300

IMPORTANT TIP



- HW DOVETAIL BITS (not included):**
- 718.127.11** D=12,7mm A=14° S=6mm
 - 818.128.11** D=12,7mm A=14° S=6,35mm
 - 918.127.11** D=12,7mm A=14° S=8mm
 - 818.628.11** D=12,7mm A=14° S=12,7mm

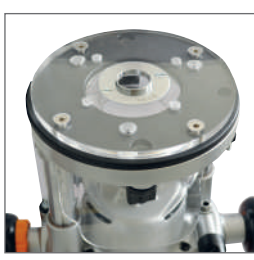

Will the template fit my router?

Standard template guide features two prebored holes with 50mm center-to-center distance and attaches via two screws. Many routers are compatible with this design. However, if yours is not, choose from the list of universal router bases here below:

- Universal router bases**
- | | |
|---|---------------------------------------|
| For Ø8 and Ø12mm shank | ORDER NO.
CMT300-SB1 |
| For Ø6,35 and Ø12,7mm shank | CMT300-SB2 |
| Prebored plastic router plate for CMT7E and CMT8E | CMT300-SB |

Here's how it works:

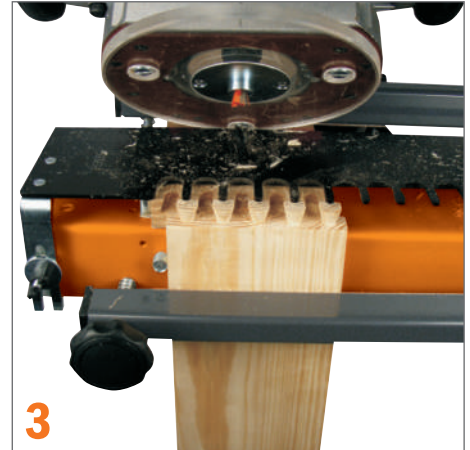

Half Blind Template **CMT300-T064**

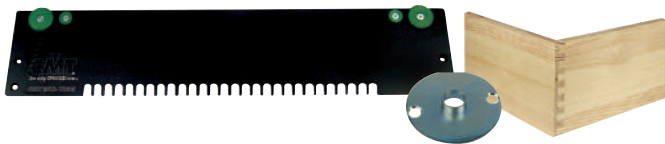

TEMPLATE LENGTH mm	DOVETAIL SIZE mm	THICKNESS mm	COLOUR	ORDER NO.
300	6,3	8 ~ 12	green	CMT300-T064

Supplied with Ø7,8x4mm precision guide

To be used with CMT dovetail router bits:

Ø6x8mm HW bit (Ø6mm shank)

Ø6,35x8,3mm HW bit (Ø6,35mm shank)



899.003.00

718.060.11

818.064.11

Through Dovetail Templates **CMT300-T129 - CMT300-T190**

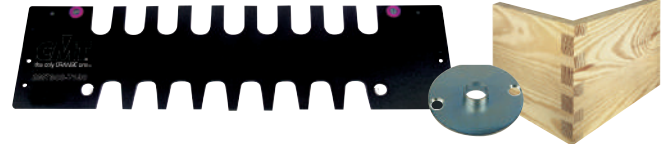

TEMPLATE LENGTH mm	DOVETAIL SIZE mm	THICKNESS mm	COLOUR	ORDER NO.
300	12,7	8 ~ 20	brown	CMT300-T129

Supplied with Ø11,1x4mm precision guide

To be used with CMT straight router bits:

Ø8x25mm HW bit (shank Ø6,35mm)

Ø8x30mm HW bit (shank Ø8mm)

To be used with CMT dovetail router bits:

Ø12,7x20mm HW bit (Ø6,35mm shank)

Ø12,7x20mm HW bit (Ø8mm shank)



899.004.00

811.081.11

912.080.11

818.129.11

918.129.11

Box Joint Templates **CMT300-T080 - CMT300-T127**

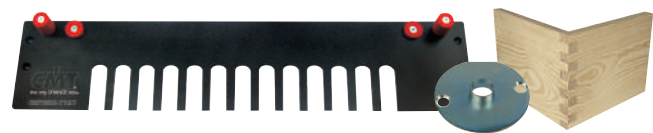

TEMPLATE LENGTH mm	DOVETAIL SIZE mm	THICKNESS mm	COLOUR	ORDER NO.
300	8	8 ~ 20	blue	CMT300-T080

Supplied with Ø11,1x4mm precision guide

To be used with CMT straight router bits:

Ø8x25mm HW bit (Ø6,35mm shank)

Ø8x30mm HW bit (Ø8mm shank)



899.004.00

811.081.11

912.080.11

TEMPLATE LENGTH mm	DOVETAIL SIZE mm	THICKNESS mm	COLOUR	ORDER NO.
300	12,7	8 ~ 20	red	CMT300-T127

To be used with CMT straight router bits:

Ø12,7x30mm bit HW (Ø6,35mm shank)

Ø12,7x30mm bit HW (Ø8mm shank)

Ø12,7x25mm bit HW (Ø12,7mm shank)



812.127.11

912.127.11

811.627.11

Precision guide for router:

DIAMETER	ORDER NO.
7,8 x 4mm	899.003.00
11,1 x 4mm	899.004.00
15,8 x 4mm	899.005.00
22 x 4mm	899.006.00
27 x 6mm	899.008.00
30 x 6mm	899.007.00

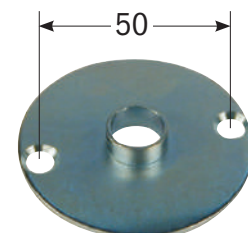

HERE ARE A FEW OF THE BEAUTIFUL DOVETAIL JOINTS YOU CAN PRODUCE USING CMT BITS

Half blind



CMT300 - T064
CMT300 - T128 (INCLUDED with CMT300)

Box joint

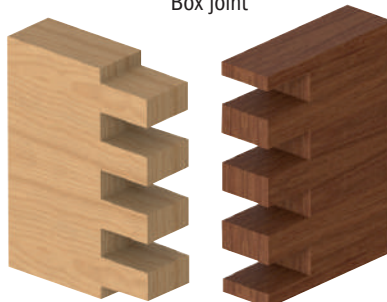

CMT300 - T080
CMT300 - T127

Through dovetail



CMT300 - T129
CMT300 - T190

Ellipse & Circle Cutting Jig

CMT3000

This product has been designed for cutting ellipses and circles with any type of router. You can make ellipses and circles for windows, doors and any other application. By using two slides into the T-slot you can cut ellipses, whereas if you use one slide, you can cut circles.



Watch the video on
YouTube



Slider in the T-slot of the cross frame

CMT3000 ellipse jig includes:

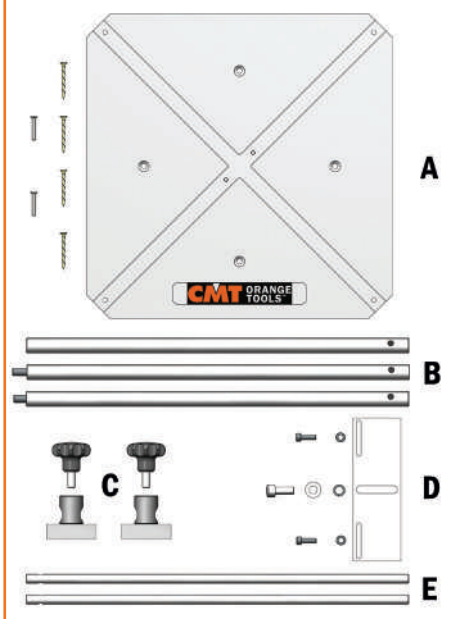

- A) 1 x Cross frame in DERLIN® with T-slot
- B) 3 x Threaded bars Ø16x400mm
- C) 2 x Sliders
- D) 1 x Connector Plate
- E) 2 x Fence rod Ø10x400mm

Spanners set
Instruction manual

Ellipse and circle cutting jig:

- Precise and rapid creation of ellipses and circles.
- Simple setup and effective operating.
- Clamping system for any type of routers.
- Special plastic cross frame with excellent sliding performance.
- Precisely machined T-slots and steel sliders.
- Zinc-coated metal parts to prevent rust.
- Delivered in a carton box along with instruction manual.

Major axis (mm)	Minor axes (mm)	
	Max	Min.
3000	2890	2590
1800	1690	1390
1500*	1390	1090
1030	920	620
900	790	620
730	620	620
*Min/Max radius routing with standard equipment		550/1500
Package dimension (mm)		445x360x85
Weight		6

Optional



CMT3000-SB1
Ø170x15mm DELRIN® guide plate for CMT3000 to be used with CMT7E & CMT8E

DESCRIPTION	ORDER NO.
Ellipse & Circle Cutting Jig	CMT3000
Optional: 400mm robust bar to extend the working radius	CMT3000-7
2 fence rods Ø8mmx400mm for small routers	CMT3000-8
Ø170x15mm DELRIN® guide plate for CMT3000 to be used with CMT7E & CMT8E	CMT3000-SB1

HERE ARE A FEW EXAMPLES YOU CAN CREATE USING CMT3000 ELLIPSE

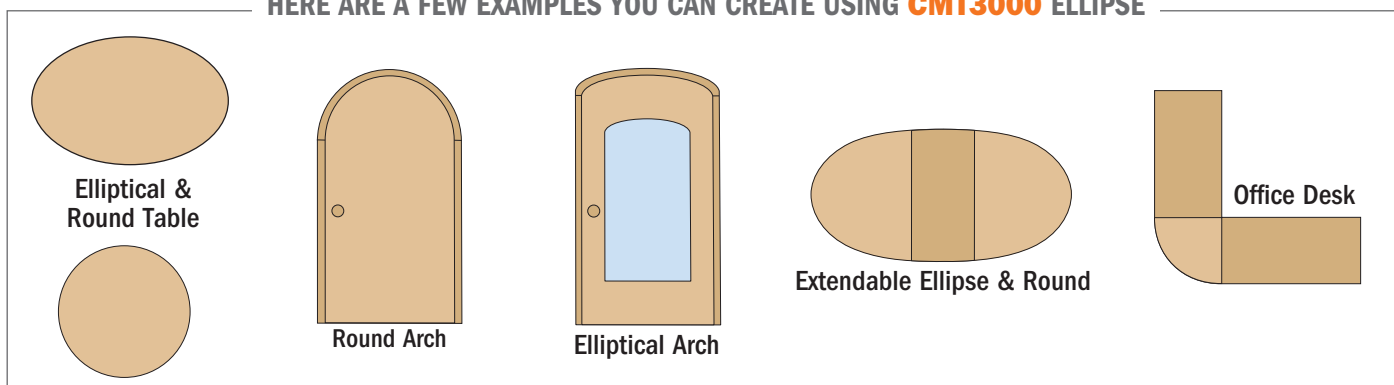

CMT650

The Jig for Perfect Joinery!

For use on worktops ranging from 420mm to 650mm in width.

Designed to cut kitchen worktop joints with any type of router.

Letter code system for different operations speeds up and simplifies jig work.

Dimensions: 880x300x 10mm.



JOINTS MADE IN 15 MINUTES! INCLUDING SETUP TIME

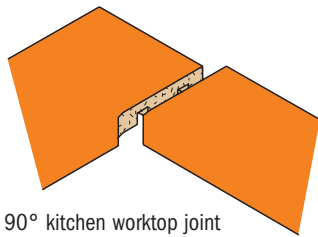

90° kitchen worktop joint

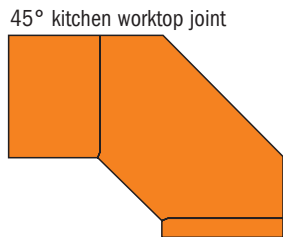

45° kitchen worktop joint

JIG INCLUDES:

- 1 Phenolic template
- 3 Zinc-coated steel guide bushes
- 1 Adjustable end stop
- 1 Instruction manual

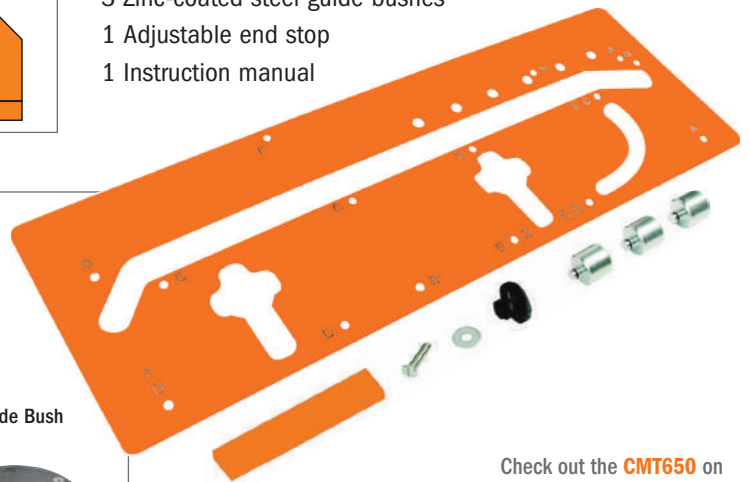

Optional

- Portable router
- Guide bush Ø30mm*
- HW straight bit Ø12mm
- Two clamps

* COMBINATION ROUTERS/ACCESSORIES

Router	Guide bush	Base Plate
CMT7E	899.007.00	CMT300-SB
CMT8E	899.007.00	CMT300-SB
NO-CMT	899.007.00	CMT300-SB1

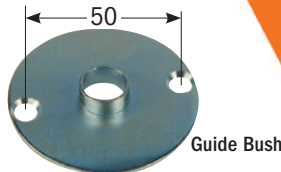

Guide Bush

Prebored Plastic Base Plate



652



8/912

Bits for the jig:

We recommend the use of these Ø12mm straight bits:

ORDER NO.	DESCRIPTION
912.120.11	Ø12x31,7 S=8mm
652.120.11	Ø12x28,3 S=8mm
912.621.11	Ø12x38,1 S=12mm
912.622.11	Ø12x50,8 S=12mm
812.620.11	Ø12x31,7 S=12,7mm
812.621.11	Ø12x38,1 S=12,7mm
652.121.11	Ø12x48,3 S=12mm
652.621.11	Ø12x48,3 S=12,7mm

Check out the CMT650 on



DESCRIPTION	ORDER NO.
Kitchen Worktop Jig	CMT650

CMT650 is designed for Ø12mm straight bits.

- Template made of stable and hardened material.
- For 90° and 45° joints
- Integrated templates for rounding over and chamfering edges.
- Extra guide bush for worktop width of 600mm.
- Two integrated templates for panel bolt recesses.
- Delivered with a clear and comprehensive instruction manual.

Universal Hinges Boring System

The innovative **CMT333** Hinge Boring System with 3 spindle-heads allows you to bore holes for any hinge brand. The universal modular base supports the installation of many boring heads engineered by worldwide leading companies in the sector. Use the **CMT333** universal hinge boring system on all hand-held or standing drill press tools.

CMT333

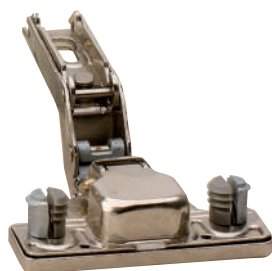

COMPATIBLE WITH MANY HINGE TYPES

Check out the **CMT333** on **YouTube**



Ø8mm hexagonal shank suitable for any drilling machine.

Ground chromium plated slide bars (Maximum Length 90mm).

Depth lock.

Greasing point.

Double screws for secure fastening.

Spare parts

	
990.009.00	991.067.00

Ø10mm bores for panel setting bars.

BORING HEAD NOT INCLUDED
Choose from one of these options:

- **CMT333-4211**
- **CMT333-4809**
- **CMT333-4300**
- **CMT333-5255**
- **CMT333-4595**
- **CMT333-325**

Slide bar for panel setting

Plywood base



For use on standing drill presses and the CMT Industrio Routing Table.



TECHNICAL FEATURES

- All parts rust-proof
- Ground aluminum
- Max 5000 RPM
- Six radial antifriction bearings

SAFETY TIPS:

We recommend **Mobil SHC100** for lubrication

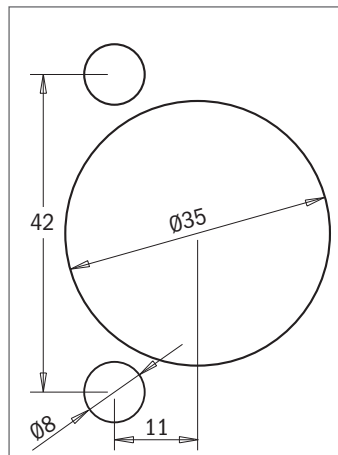

1 **CMT333-4211**
for GRASS® hinges 42/11

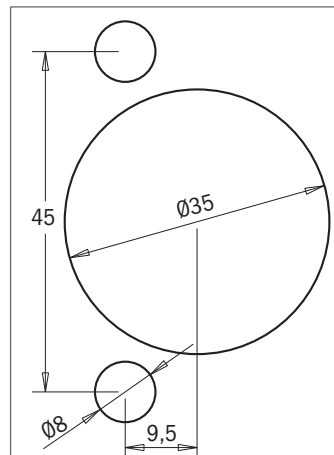

2 **CMT333-4595**
for BLUM® hinges 45/9,5

CMT333



Example BLUM® hinge

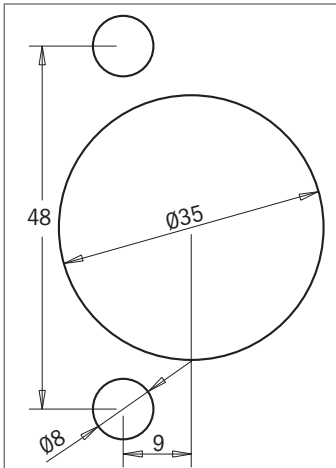

3 **CMT333-4809**
for MEPLA® hinges 48/9

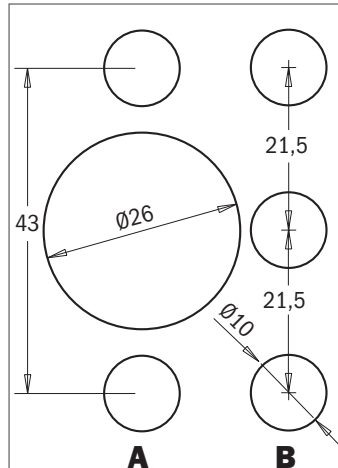

4 **CMT333-4300**
for window handles 43/00

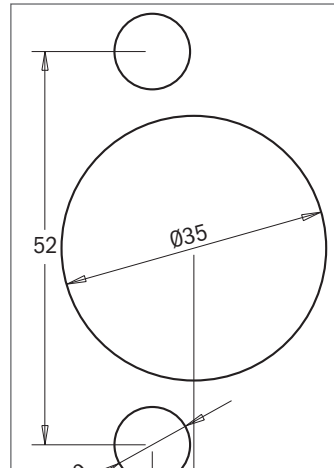

5 **CMT333-5255**
for HETTICH®, WÜRTH® hinges 52/5,5



MAXIMUM VERSATILITY

Support modular base	Boring heads	Drill bits	Boring bit
ORDER NO.	ORDER NO.	S	ORDER NO.
CMT333	CMT333-4211	8mm	310.080.12 (2 pcs.) Left-hand rotation
CMT333	CMT333-4595	Hexagonal	310.080.12 (2 pcs.) Right-hand rotation
CMT333	CMT333-4809	8mm	310.080.12 (2 pcs.)
CMT333	CMT333-4300	Hexagonal	310.100.12 (2 pcs.)
CMT333	CMT333-5255	Hexagonal	310.100.12 (2 pcs.)
CMT333	CMT333-325	Hexagonal	(3 pcs. RH + 2 pcs. LH)

Make your set

Choose your hinge

1	GRASS®	42/11
2	BLUM®	45/9,5
3	MEPLA®	48/9
4	Window handles	43/00
5	HETTICH®, WÜRTH®	52/5,5
6	SYSTEM 32	32

Boring Head System 32

The universal modular base **CMT333** supports the installation of the System 32 with 5 adapters.

CMT333-325

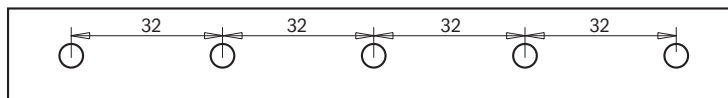

DESCRIPTION	ORDER NO.
Boring head with 5 adapters for System 32	CMT333-325

BLUM® Hinge Boring Head

The innovative **CMT334** BLUM® Hinge Boring Head features three spindles which allow you to bore hinge holes cleanly and efficiently. For use on boring and point-to-point machines.

CMT334

DESCRIPTION	ORDER NO.
Hinge Boring Head (bits not included)	CMT334-4595
Boring Bit Ø35mm x 38,5mm. Right-hand rotation	393.350.11
Dowel Drill Ø8mm x 38,5mm. Left-hand rotation	393.080.12

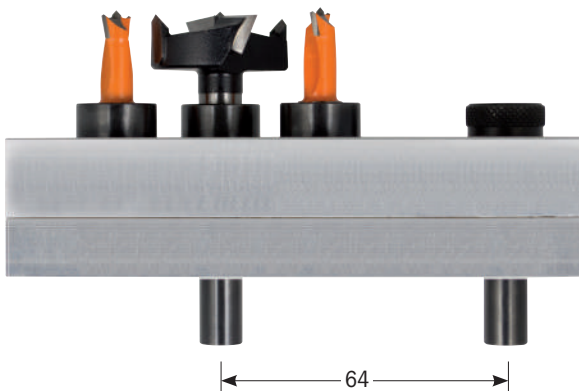

For use on boring and point-to-point machines

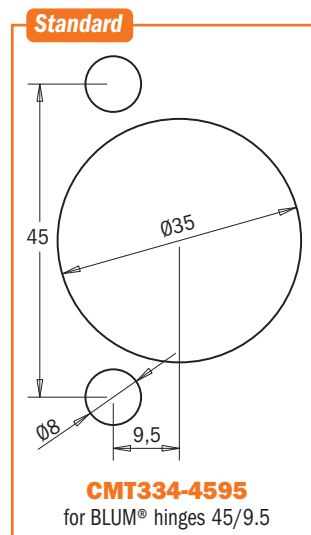

Bench Block Set

These blocks are great for holding your workpiece steady without resorting to the use of clamps. Their anti-slip surface grip adheres to both your bench top and the underside of your workpiece. By raising the workpiece off the main bench top, you automatically create extra clearance underneath so you can put your router bits and cutters conveniently to work!

Length: 75mm
Width: 50mm
Height: 25mm



DESCRIPTION	ORDER NO.
Bench block set (4-Pcs.) 75x50x25	BBS-001



BBS-001

Inlay Kit

899

The components of this kit include a spiral cutter or a straight cutter (sold separately) with a diameter of 3mm and 3.2mm and a 6mm and 6.35mm attachment respectively. The interchangeable brass rings allow you to create the cavity of your choice on the workpiece. The instruction manual shows in detail all the steps of the process. This kit offers endless decorative possibilities (toys, puzzles and lettering). The spiral cutter is recommended for use on MDF while the straight cutter is best for natural wood.

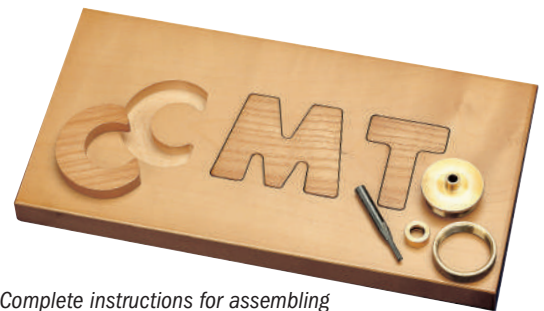

Complete instructions for assembling and using CMT inlay kit are included.

DESCRIPTION	ORDER NO.
Inlay kit with 3,2mm (1/8") HWM spiral bit (Ø6,35mm shank)	899.051.00
Inlay kit with 3,2mm (1/8") HWM straight bit (Ø6,35mm shank)	899.052.00
Solid brass template guide	899.001.00
Universal router base	899.000.01
Router base for CMT7E/CMT8E	899.000.02
3,2mm (1/8") HWM spiral bit (Ø6,35mm shank)	192.001.11
3,2mm (1/8") HWM straight bit (Ø6,35mm shank)	812.032.11
3mm HWM spiral bit (Ø6mm shank)	192.630.11
3mm HWM straight bit (Ø6mm shank)	712.030.11

Template Guide Kit

A practical 7 piece bushing kit that will extend the possibilities of your router. For template-controlled operations such as dovetailing, stair routing, hinge butt routing, lock face routing and more general template tasks.

These kits can be used with any router featuring a 30mm (1-3/16") bore baseplate. Fits the most popular routers. Some routers may require CMT's base **899.000.02**.

DESCRIPTION	ORDER NO.
Template Guide Kit	CMT-TGA



CMT-TGA

Optional

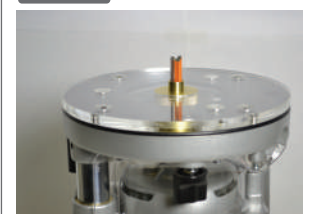

DESCRIPTION	ORDER NO.
Prebored base for CMT7E and CMT8E	899.000.02
Universal base	899.000.01

Set contains:

QTY.	1	1	1	1	1	1	1	2	1
Internal diameter	15,87mm	16,66mm	13,49mm	10,31mm	8,73mm	7,14mm	6,35mm	Lock Nut	Adapter
Outside diameter	20,24mm	19,05mm	15,87mm	12,7mm	11,11mm	9,52mm	7,93mm	Lock Nut	
Height	14,28mm	14,28mm	14,28mm	7,93mm	3,96mm	7,93mm	3,96mm		

Universal Boring Template

CMT's Universal Boring Template has been designed for carrying out precise and productive manual dowelling of furniture elements by using 32mm Euro-System screws. For boring shelf supports with 3mm or 5mm diameter and for making and marking hinge holes. This **CMT900** template will help you prebore the most popular hinge types.

For dowelling into surfaces and shelf supports and hinges



Check out the **CMT900** on **YouTube**

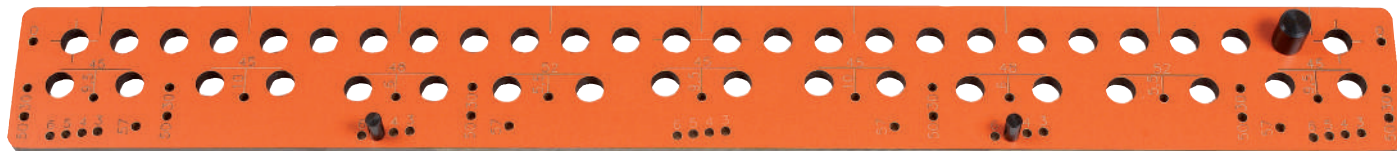

- Laminated phenolic material
- Clear and comprehensible template marking
- Precise end stops



BORING ADAPTERS (not included):

- Suitable for any type of drilling machine
- End stop for different boring depths
- DURALUMIN® body with pre-bored holes for better chip ejection
- Precise, flat seating for proper alignment

ORDER NO. **CMT400-1**
 Boring adapter for **CMT656, CMT900 JIGS**
 For bits with up to 30mm drilling depth:
306.030.21 - 306.050.11 - 306.080.11

QUICK AND EASY:

TECHNICAL DETAILS: **CMT900**
 Max. board width with clamping: 900mm
 Max board width: no limits
 Board thickness: no limits
 For dowels: Ø8mm
 Hole distance: 32mm
 Number of holes: 26
 For shelf support: Ø3mm, Ø5mm
 For hinges: Ø3mm for wooden screws
 Ø5mm for Euro screws



HW DOWEL BITS (not included):

DESCRIPTION	ORDER NO.
D=3x18mm S=8x20mm HWM	306.030.21
D=5x30mm S=8x20mm HW	306.050.11
D=8x30mm S=8x20mm HW	306.080.11

Other sizes available in **306-307 series**

Boring into a surface for dowel joints using the template.

Boring Ø3mm and Ø5mm holes for shelf supports.

Preboring holes for hinges (base and panel).



CMT900 Boring Template Includes:

- Boring template from laminated pertinax
- End stop set
- End stop set for large elements
- Centering pin for hinges

DESCRIPTION	ORDER NO.
Universal Boring Template	CMT900

Universal Boring Jig

Designed for manual dowelling of furniture elements, this jig with its 32mm perforations, guarantees high precision work and increases productivity. For use with special adapters **CMT400-1** and **CMT400-2**.

CMT656

For edge dowelling and jointing

- Precise holes
- Detachable end stops
- Ergonomic manual tighteners
- Precise and flat DURALUMIN® profile

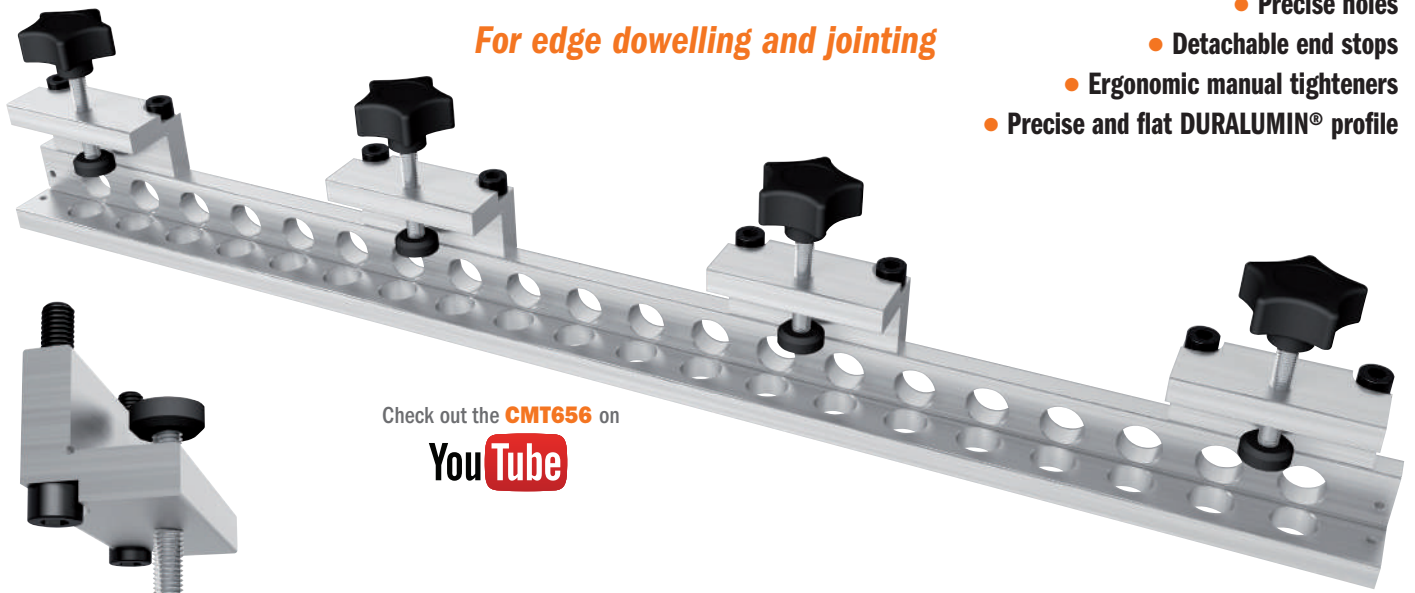

Check out the **CMT656** on



SPARE CLAMP (optional)

To speed up your work with elements of different width.
Order no. **CMT400-3**

UNIQUE SOLUTION

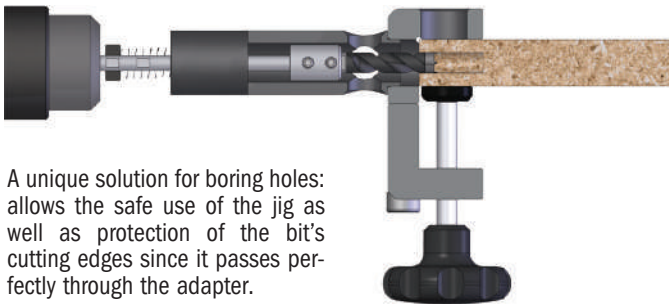

A unique solution for boring holes: allows the safe use of the jig as well as protection of the bit's cutting edges since it passes perfectly through the adapter.

BORING ADAPTERS (not included):

- End stop for different boring depths
- Suitable for any type of drilling machine
- DURALUMIN® body with holes for better chip ejection
- Precise and flat seating for proper alignment.

ORDER NO. **CMT400-1**

Boring adapter for **CMT656, CMT900 JIGS** to use with drills bit:

306.030.21 - 306.050.11 - 306.080.11 - 307.050.11

ORDER NO. **CMT400-2** (for screw joints)

Boring adapter for **CMT656, CMT900 JIGS** to use with drill bit **307.050.11**



3 EASY STEPS IN CREATING DOWEL JOINTS



Place the jig onto the board, fix the end stop and tighten the workpiece. Set the bore depth and clamp the boring adapter on your drilling machine. Bore vertical holes.



Fasten the jig on the other element, fix the end stop and set the bore depth. Bore horizontal holes.



Now insert the dowels with glue into the holes and join both elements.



As an alternative, use through hole bits and screw the elements together.

HW DOWEL BITS (not included):

DESCRIPTION	ORDER NO.
D=3x18mm S=8x20mm HWM	306.030.21
D=5x30mm S=8x20mm HW	306.050.11
D=8x30mm S=8x20mm HW	306.080.11
D=5x40mm S=8x20mm HW	307.050.11 for screw joints
D=7x40mm S=8x20mm HW	307.070.11 for screw joints

Other sizes available in **306-307** series

TECHNICAL DETAILS: **CMT656**

Max board width (once clamped down)	656mm
For dowels:	Ø8mm
For through holes:	Ø7mm
Hole distance:	32mm
Number of Ø18mm holes:	2x20
Board thickness max:	40mm
Overlap (post-assembly):	0,8mm

DESCRIPTION	ORDER NO.
Universal Boring Jig (656mm in one tightening)	CMT656

3D Router Carver System

Exclusively from your CMT distributor

RCS

Turn your router into a remarkable carving tool. It's fast, easy, and a whole lot of fun!

Who says that intricate woodcarving requires an artist's touch? Thanks to the patented 3D Router Carver system, anyone with a plunge router can create any of the beautiful designs shown on these pages in just minutes. Decorate doors, drawers, cabinets, furniture or just about any flat wooden surface with one or more of these designs. How does it work? The secret is in the 3D Router Carver Bit and the way that bit interacts with the carving templates. The V-Groove router bit is enclosed in a 45° cone-shaped guide. You rout with the plunge mechanism of your router unlocked, allowing the bit to move up or down as the router moves forward. As the slot in the template get wider, the bit moves down, producing a wider, deeper V-groove. As the slot gets narrower, the bit moves up, and the groove gets narrower and shallower. It sounds simple, and it is! (that's why the system is patented worldwide). Please see the illustrations below for more details on the carving technique. You'll receive complete instructions with your 3D Carver templates. For an informative visual demonstration, check out the 3D Router Carver video on our web site.

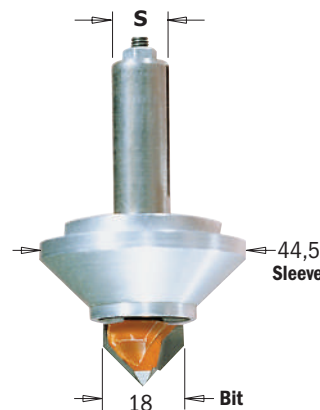







What do you need to get started?

- The 3D Router Carver bit
- The Carver template of your choice
- The Holding frame to match your template
- Your plunge router

Check out
3D Router Carver System on
YouTube

(Note: Be sure the opening at the base of your router is at least 47,6mm in diameter. If it isn't, you'll need to make a sub-base to accept the large diameter of the 3D Carver bit.)

3D Router Carver Bit & Sleeve

S mm	ORDER NO. Right-hand rotation	Spare parts					Optional
8	RCS-BIT8		 44,5				 39
12,7	RCS-BIT	RCS-CUT8	RCS-SLE8	RCS-SHIELD	RCS-NUT8	991.007.00	RCS-SLEEVE8
		RCS-CUT		RCS-SHIELD	990.091.00	990.092.00	

Here's how it works:

1. Clamp or tack the holding frame to your workpiece

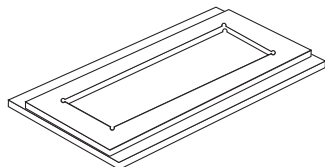

2. Drop the template into the center of the frame

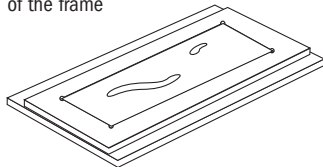

3. Plunge the bit into a wide part of the slot and rout with the router's plunge mechanism unlocked.

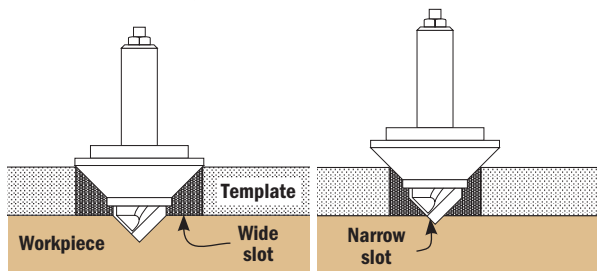

Allow the plunge mechanism to move up and down as you advance.
Wider template slots allow wider, deeper grooves.
Narrower slots produce shallower grooves.

4. With the frame still in place, flip the template & rout again. Some templates will be routed 2 to 4 times, depending on the complexity of the design.

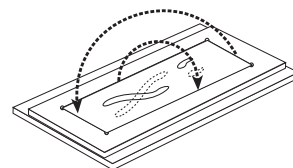

5. Remove the frame and you're finished!

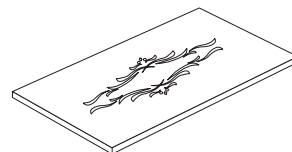

Cabinet door & Panel Carvings

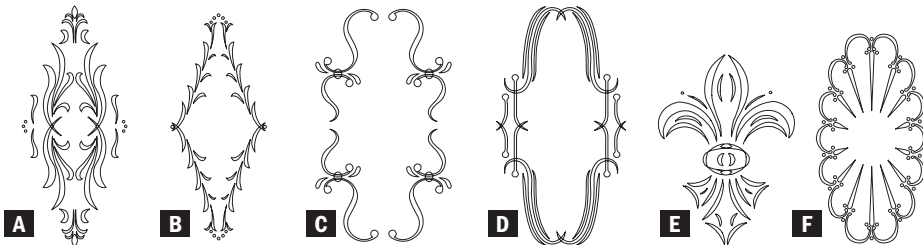

These designs are ideal for the doors or panels of cabinets, entertainment centers, fireplace surrounds or almost any flat surface. See the designs below for complementary patterns for drawers, rails and corners. Approximate carving time is 5 minutes.

DESCRIPTION	CARVING DIMENSIONS mm	No. OF TEMPLATES	ORDER NO.
Classical cabinet door - A	440 x 185	2	RCS-302
Florentine cabinet door - B	415 x 170	2	RCS-304
Cascade cabinet door - C	365 x 210	1	RCS-305
Roma cabinet door - D	375 x 200	1	RCS-306
Fleur-de-Lys door - E	250 x 180	4	RCS-805
Spanish fan template - F	380 x 200	2	RCS-806
Cabinet door holding frame			RCS-003



Tip: Many carvings, like the Florentine rail, are enhanced with the addition of a rosette.



Panel & Rail Carvings



With a long, horizontal shape, these designs are perfect for door rails, headboards, cabinet face frames and valences. Approximate carving time is 4 minutes.

DESCRIPTION	CARVING DIMENSIONS mm	No. OF TEMPLATES	ORDER NO.
Classical Rail - A	550 x 120	2	RCS-402
Florentine Rail - B	550 x 130	2	RCS-404
Cascade Rail - C	530 x 110	3	RCS-405
Folklore Rail - D	550 x 110	3	RCS-406
Rail Holding Frame			RCS-004

Drawer & Furniture Carvings

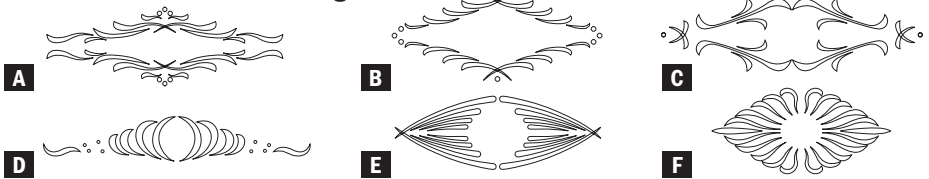

Originally intended for drawer fronts, these designs are great for lots of other projects: small doors, side panels of cabinets, furniture and more. For door and drawer combinations, match the style of the door designs above. Approximate carving time is 4 minutes.

DESCRIPTION	CARVING DIMENSIONS mm	No. OF TEMPLATES	ORDER NO.
Classical Drawer - A	210 x 70	2	RCS-502
Florentine Drawer - B	195 x 85	2	RCS-504
Cascade Drawer - C	250 x 65	1	RCS-505
Folklore Drawer - D	250 x 40	2	RCS-506
Roma Drawer - E	190 x 65	2	RCS-507
Blaze Drawer - F	250 x 110	2	RCS-510
Drawer Holding Frame			RCS-005

Corner & Small Decoration Carving Designs



DESCRIPTION	CARVING DIMENSIONS mm	No. OF TEMPLATES	ORDER NO.
Classical - A	155 x 40	3	RCS-602
Florentine - B	120 x 30	3	RCS-604
Cascade - C	190 x 40	3	RCS-605
Folklore - D	150 x 45	3	RCS-606
Corner Holding Frame			RCS-006

Rosette Carvings

You get two templates for the price of one with these designs! Each item includes templates for two sizes of rosette. Use with the rosette frame sold above, or use the large rosettes with the cabinet door frame or small rosettes with rail frame.

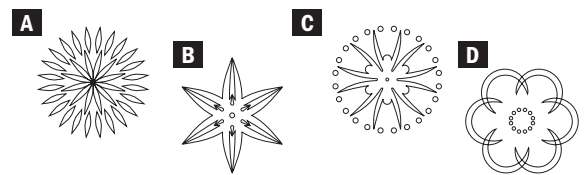

DESCRIPTION	CARVING DIMENSIONS mm	No. OF TEMPLATES	ORDER NO.
Rosette #1 & #5 - A	85 x 68	2 & 2	RCS-701
Rosette #2 & #6 - B	88 x 70	1 & 1	RCS-702
Rosette #3 & #7 - C	82 x 65	1 & 1	RCS-703
Rosette #4 & #8 - D	79 x 62	1 & 1	RCS-704
Rosette Holding Frame			RCS-007

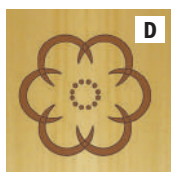
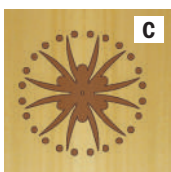
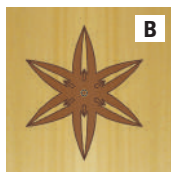
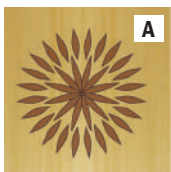

3D Router Carver System

RCS

Southwestern Carving Designs

These popular Southwestern designs are actually several shapes in one. Both sizes can be routed as circular carvings, or use only portions of the template to suit your project.

Rout the complete spanish fan design or make partial rosettes

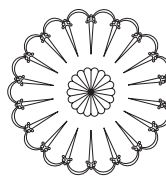
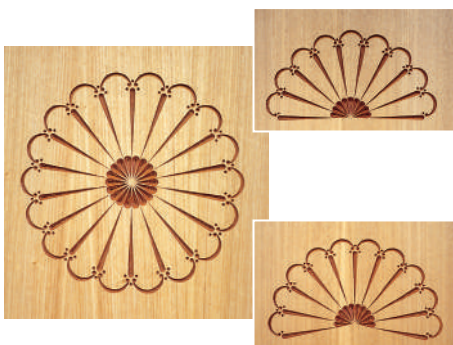

DESCRIPTION	CARVING DIMENSIONS mm	NO. OF TEMPLATES	ORDER NO.
Large Spanish Fan	400	1	RCS-801
Small Spanish Fan	200	1	RCS-802
Rosette Holding Frame			RCS-007

Special designs for animal lovers!

Your imagination will be your guide on these neat designs. Furniture or decorations for the kids, paneling for the den or rec room, a gift for the sportsman.

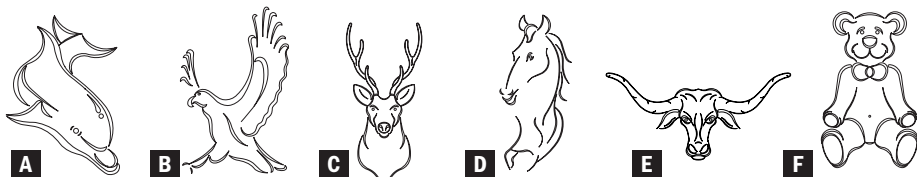

DESCRIPTION	CARVING DIMENSIONS mm	NO. OF TEMPLATES	ORDER NO.
Dolphin - A	200 x 290	4	RCS-803
Eagle - B	178 x 298	4	RCS-804
Deer - C	394 x 190	4	RCS-901
Horse - D	445 x 203	3	RCS-902
Longhorn - E	419 x 194	4	RCS-904
Teddy bear - F	394 x 203	3	RCS-906
Cabinet Door Holding Frame			RCS-003

Bit Organizer

100 bits at your fingertips

You always need your most used bits within reach! They also need to be safely organized. CMT offers a perfect solution for keeping them in order with a handy organizer. Conveniently holds up to 100 router or drill bits of any size with the use of a CMT interchangeable bushing to fit all shank diameters. See options listed below.

03.51



DESCRIPTION	ORDER NO.
Bit Organizer 320x320x45mm (without bushings)	03.51.0106
Interchangeable Bushings for Ø6mm shank (20-Pcs.)	03.51.0046A
Interchangeable Bushings for Ø6,35mm shank (20-Pcs.)	03.51.0047A
Interchangeable Bushings for Ø8mm shank (20-Pcs.)	03.51.0048A
Interchangeable Bushings for Ø9,5mm shank (20-Pcs.)	03.51.0057A
Interchangeable Bushings for Ø10mm shank (20-Pcs.)	03.51.0058A
Interchangeable Bushings for Ø12mm shank (20-Pcs.)	03.51.0059A
Interchangeable Bushings for Ø12,7mm shank (20-Pcs.)	03.51.0049A

Formula 2050: Blade & Bit Cleaner



An incredibly effective cleaner for all cutting tools!

998

Saw shops know how to get the most out of cutting tools. They also know that pitch and residue build-up greatly shorten the life of carbide and compromise performance. We asked various blade sharpeners to test our **Formula 2050** and they all rated it as an excellent product. Why is it so effective? Because CMT's **Formula 2050** penetrates the microscopic cracks in the resin and attacks the bond between carbide/steel surface and the resin itself. **Formula 2050** keeps your tools in top-notch condition increasing lifespan between sharpening and replacement.



998.001.01



998.001.03

Prolonged use of this product may cause damage to special coating treatments applied to aluminum tool surfaces. Use with caution.

DESCRIPTION		ORDER NO.
0,5 lt. spray bottle	8	998.001.01
5 lt. plastic jug	2	998.001.03

- Removes pitch, resin and adhesive residue from all woodworking cutting tools (saw blades, router bits, drill bits, shaper cutters, planer blades, etc.)
- Do not rinse after cleaning. Formula 2050 provides protection from rust and corrosion. Keeps your table saw top rust-free, too!
- Can be applied by spray bottle or used in ultrasonic cleaners and dip tanks.

Contact our Sales Department for terms and conditions of delivery and minimum quantity orders.

Formula 998: Lubricant for Wood, Neutralizes Resin

- Neutralizes resin, preventing it from being stuck on chips and sawdust.
- Cleans knobs, barbell handles, etc.
- Anti-corrosion action on woodworking machine table.
- Excellent against humidity.

998

DESCRIPTION		ORDER NO.
1 lt. spray bottle	12	998.002.01
5 lt. plastic jug	2	998.002.03

Contact our Sales Department for terms and conditions of delivery and minimum quantity orders.



Watch the video on 



998.002.01



998.002.03



INSTRUCTION: spray or use a brush to apply the product on machine parts. A uniform layer of product on surfaces helps the workpiece slide better, reduces attrition and prevents sticking.

Flexible Templates for Curved & Arched Routing

The CMT flexible template is easy to screw on any kind of wooden panels, MDF or chipboard for creating forms, arcs and curved elements easily and rapidly. In order to fix your template you can use countersunk screws, which are widely available on the market. The CMT template is made of a highly-resistant flexible plastic, which can be tied in knots without any risk of ruining or reducing flexibility.

Screw your template to the edge of the panel and follow its shape and rout the border on the guide ring. The template is suitable for manual feed on routers, router tables and spindle moulders. Rout easily, safely and accurately to make multiple forms such as arcs, curved elements and cut-out forms. Mark the edge of your form precisely and screw it onto a previously-placed panel from underneath.

If you rout with a guide ring mounted onto your spindle moulder, keep your hands a safe distance behind the template. Two different profiles in three lengths are available. Please notice that the smallest profile features a short radius, whereas the larger profile features a larger opening in case of flat and long curves.

- Special plastic without any plasticizer.
- Made in Germany.
- Lasts more than 10 years!

Check out the **Flexible Template** on

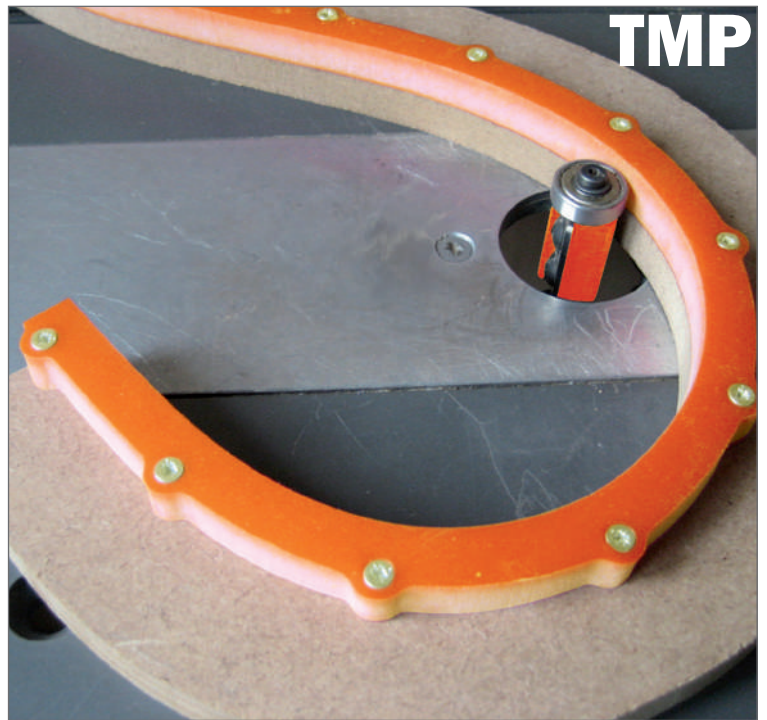

DESCRIPTION	L mm	ORDER NO.
Flexible template for routing 18x18mm	1000	TMP-1000
Flexible template for routing 12x12mm	1200	TMP-1200
Flexible template for routing 18x18mm	2000	TMP-2000

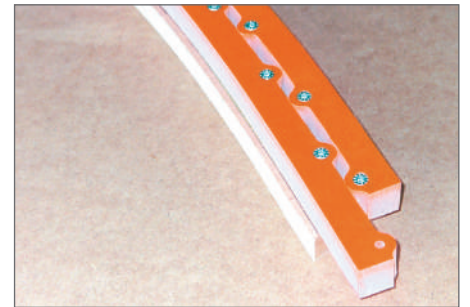
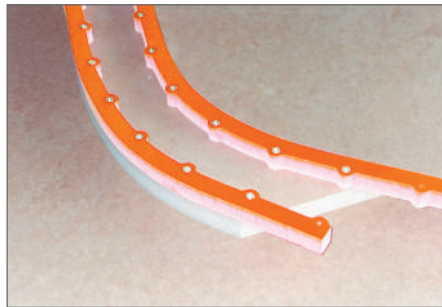

12 Corner Radius Router Template Set from 3mm to 25mm

Our useful 3-piece corner radius template set includes 8mm thick acrylic templates that will allow you to make 12 different radii (4 per template) by using a flush trim or a pattern bit (sold separately). Included with the templates you will also find 4 alignment pins and 4 wood screws.

Use the pins to align the template onto your workpiece, then use the four wood screws provided to secure it. Remove the alignment pins and use the bit to cut the corner of your workpiece to the same radius as the template.

RADIUS	
mm	inches
3	1/8"
5	3/16"
6	1/4"
8	5/16"
10	3/8"
11	7/16"
12	1/2"
14	9/16"
16	5/8"
19	3/4"
22	7/8"
25	1"

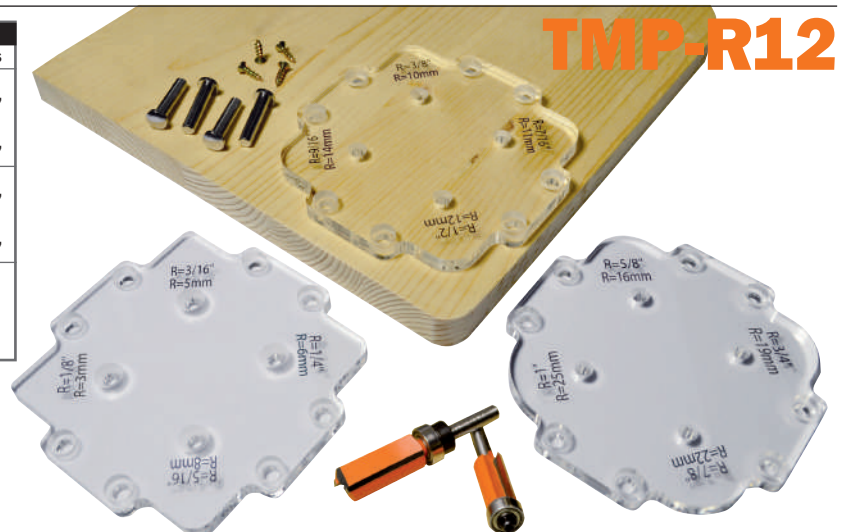

DESCRIPTION	ORDER NO.
12 Corner Radius Router Template	TMP-R12
Set contains:	
12 Different Radii (3 templates)	
4 Alignment Pins	
4 Wood Screw	

Contour Duplicator Gauge

new

CMT ORANGE TOOLS

CDG-001

For precision tracing of shapes, even curved, in a variety of materials. Easy sliding calipers designed to mold and duplicate any form: pipes, columns, tubing, regular and irregular walls, baseboards, crown molding, door and window framework. For use on applications such as tile, wood, wood derivatives, composite, porcelain, ceramic, vinyl, flooring for easy tracing, fitting and installation. No guesswork, no patch jobs, less waste!

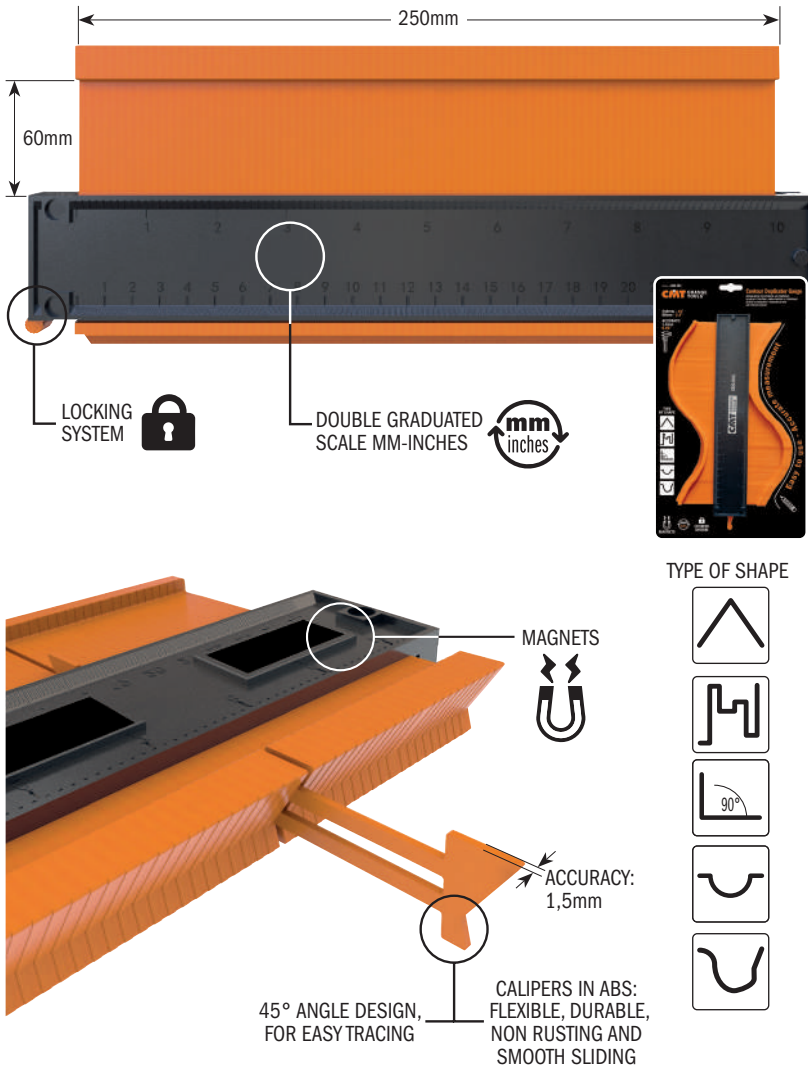

DESCRIPTION	BOXES	ORDER NO.
Contour Duplicator Gauge	5	CDG-001

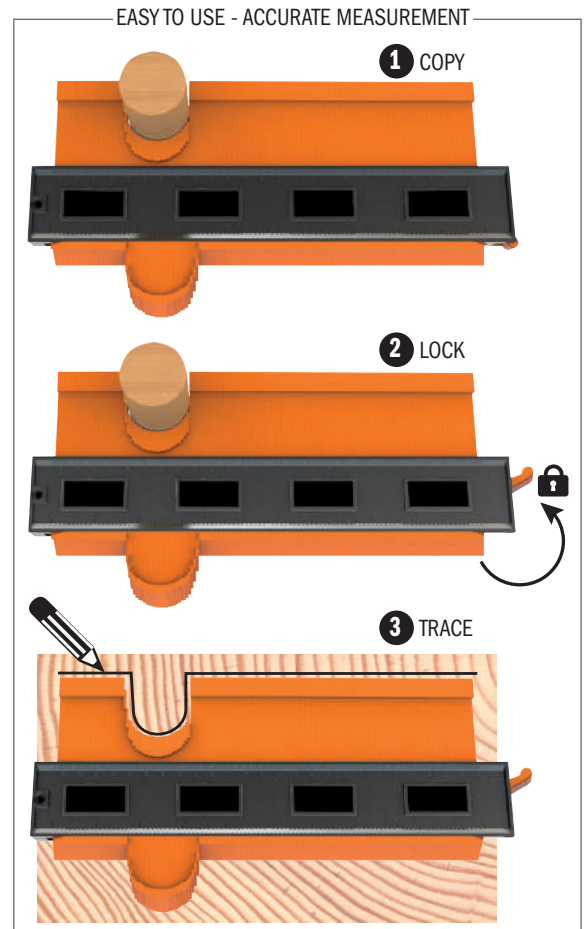

Adjustable Corner Frame Clamps

new

CFC-002

CMT Adjustable Corner Frame Clamps will easily create the perfect 90° angle or handy T-joints typical in shelving, cabinets and frame applications using boards of variable thicknesses from 6 to 25.4 mm. These clamps allow you to work independently, and above all, hands-free so you can glue, dry-fit, nail, screw, or square your joint securely and accurately - just like a professional. The special design allows you to immobilize the panels from the inside (hex key) and from the outside (knob) according to your project needs. Set up is easy as 1-2-3: position the clamp, twist the knob and presto! Equal pressure is instantly applied on each side of the corner and you have a perfectly squared 90° joint! Made of sturdy and durable plastic material, the clamp features a double graduated scale in mm/inches for a broad range of adjustments.



DESCRIPTION	ORDER NO.
2 pcs. Adjustable Corner Frame Clamps 100x100x35	CFC-002

Digital Height Gauge

DHG-001



- Precise measurements for router bits, saw blades, band saw blades, cutter heads, drill bits, holes depth.
- Measuring ruler with Metric/Imperial scale and locking screw.
- Horizontal & vertical measuring.
- Digital easy-to-read display.
- Self-standing with magnets, for setting cutting depth on router tables and low profiles for backfence adjustment.
- Instruction manual.



Place your gauge on a flat surface and set to "0" on the display.

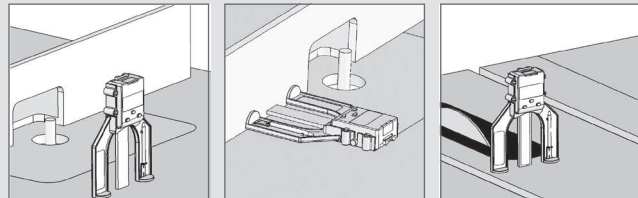

Position your gauge on the desired position.

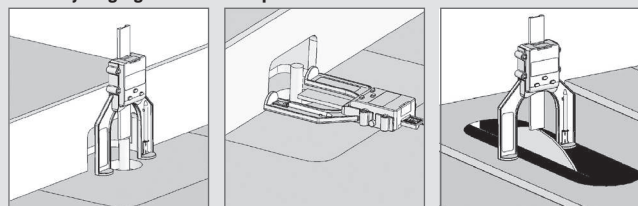

Insert needle and set to "0".

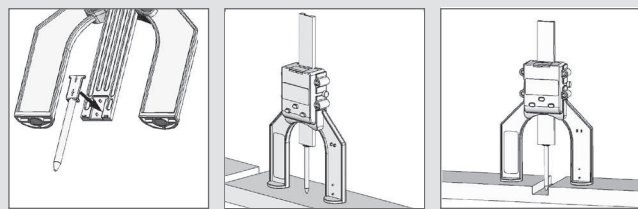

TECHNICAL DETAILS:

- Measuring range:Scale: 0~80mm (0~3-1/8");
- Needle:0~50mm (0~2")
- Wide opening:60mm (2-23/64")
- Resolution:0.05mm (0.002")
- Accuracy:±0.1mm (±0.004")
- Battery:**Included**
- Battery Type:CR2032-3V; Lithium Button Cell

DESCRIPTION	BOX	ORDER NO.
Digital Height Gauge	8	DHG-001

Digital Moisture Meter

DMM-001



Ideal for use in woodworking, building construction and agriculture industries. The **DMM-001** is also an invaluable tool in the restoration field. Ideal for locating moisture in carpets and sub-flooring. Ultra-sensitive Digital Moisture Meter easily detects hidden leaks in wood, concrete, plaster and carpet. Providing accurate moisture level readings make this tool great for new home inspections, locating roof leaks or even selecting dry lumber at the yard. Display will show the moisture content in Percent Moisture Content directly.



Calibration holes

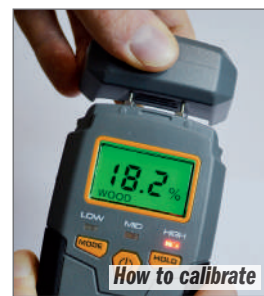

How to calibrate

TECHNICAL DETAILS:

- Moisture measuring range: 5~50% (in wood); 1.5~33% (in building material)
 - Measuring accuracy: ±2%
 - Backlight shut off: Approx. 15 seconds
 - Auto power off: After 3 minutes idle
 - Battery:**Included**
 - Battery Type:9V Battery Block (6F22 or 6LR6); Alkaline
 - Low battery indicator: <7V
 - Working current: <25mA
 - Working temperature: 32°F~122°F
 - Working humidity: <90%RH non-condensing
 - Storage: -4°F~140°F ≤85% (without battery)
 - Dimensions: 145 x 65 x 25mm (5-11/16" x 2-9/16" x 1")
 - Weight: About 3oz (without battery)
- Measures moisture content by detecting a material's electrical resistivity using two pins.
 - Measurement output is displayed on a practical LCD screen.
 - Instruction manual.



DESCRIPTION	BOX	ORDER NO.
Digital Moisture Meter	5	DMM-001

Spare parts DMM-001/1 Set 2 Pin for DMM-001

Digital Angle Gauge

DAG-001



The digital angle gauge is a mini waterproof digital protractor that provides digital readings between $\pm 90^\circ \times 4$ with a resolution of 0.1° and features auto shut off after 5 minutes. It is small enough to be carried around in your pocket and the LED screen is easy to read. It incorporates magnets in the base for adhesion to any ferrous surface to accurately measure mitre and bevel angles on mitre saws, saw benches, etc.

- Accurately sets saw blade bevel angle, works great for miter saws and table saws.
- Automatic LCD backlight
- Large display for easy digital reading
- Measurements in absolute or relative mode
- Angles displayed in degrees
- Automatic digit inversion for overhead measurements
- Set to ZERO
- Magnetic base
- Case included
- Instruction manual

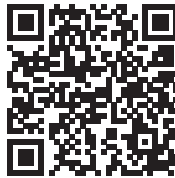

Watch the video on **YouTube**

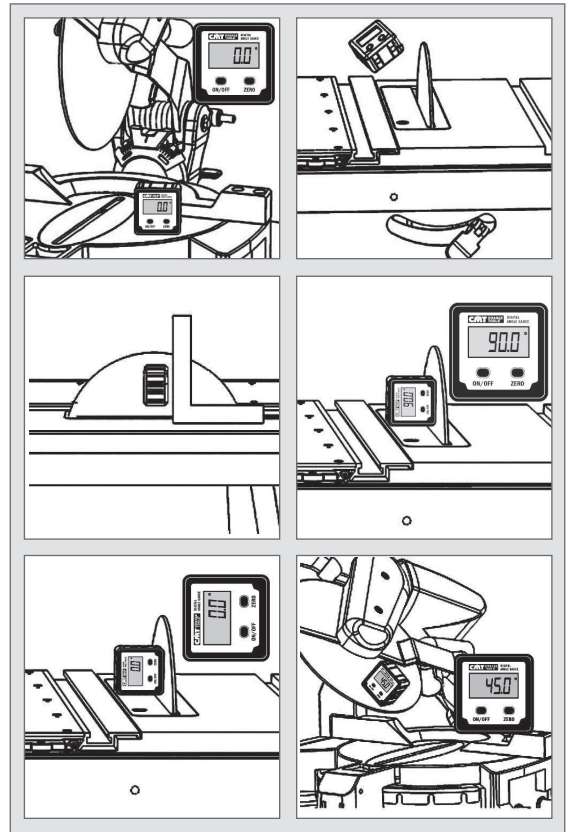

TECHNICAL DETAILS:

- Range: $\pm 90^\circ \times 4$
- Resolution: 0.1°
- Battery: **Included**
- Battery Type: AAA-1.5V; Alkaline
- Dimensions: 60 x 60 x 28mm (2-3/8" x 2-3/8" x 1-1/8")

DESCRIPTION	ORDER NO.
Digital Angle Gauge	DAG-001

Digital Angle Finder

DAF-001



This digital angle finder is a multi-functional tool for many measuring applications. Easy to operate, the base unit carries the electronics featuring clear detailed LCD display, a pair of levelling vials and a pivoting measuring arm. When the arm is extended, the angle created with the base is indicated clearly on digital read-out to the nearest 0.05° . The measuring range is $0 - 360^\circ$. The vials allow both vertical and horizontal variations to be accurately measured. Other features include a lock function to prevent the last measurement being lost, a low battery indicator and automatic shut off function. Robust yet lightweight, this tool is very versatile.

DESCRIPTION	ORDER NO.
Digital Angle Finder	DAF-001



Watch the video on **YouTube**



- Easy and simple to use.
- Calculates angles in seconds.
- Large detailed LCD display.
- Robust, lightweight aluminium construction.
- Instruction manual.

TECHNICAL DETAILS:

- Range:..... $0 - 360^\circ$
- Resolution: 0.05°
- Battery: **Included**
- Battery Type: ... CR2032-3V; Lithium Button Cell
- Dimensions: 260 x 50 x 25mm (10-1/4" x 2" x 1")

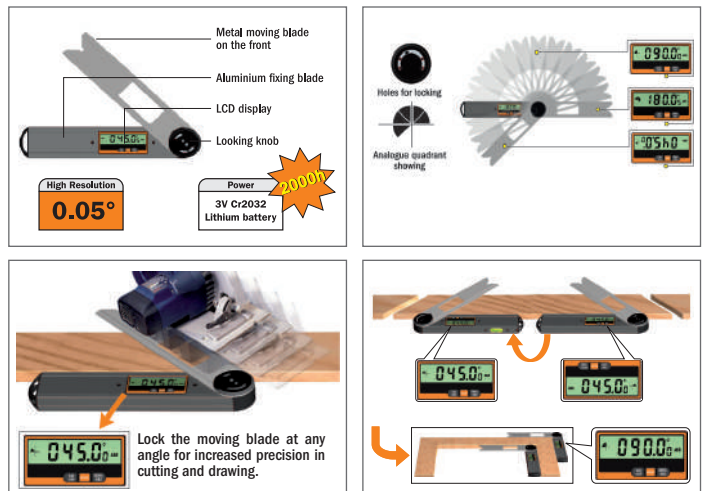

Adjustable Torque Screwdriver Set 1~6 Nm

new

CMT ORANGE TOOLS®

TW-006



The Adjustable Torque Screwdriver set includes 20 types of inserts and provides a sturdy protective case to store and keep tools safe. In addition to the instruction manual, inside you'll find the calibration certificate (unique for each instrument) according to DIN ISO 6789 & ASME B107.300-2010.

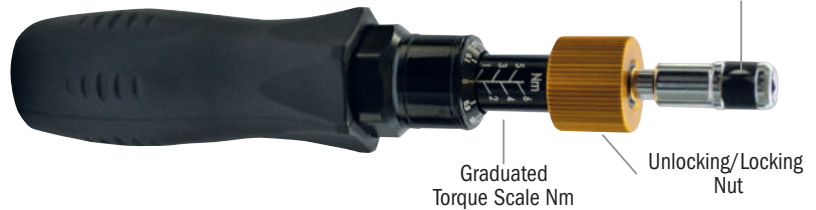

SET CONTAINS:

- Torque screwdriver
 - 20 types of inserts:
 - Plastic case
 - Instruction manual
 - Calibration certificate
- ⊕ 0-1-2-3 (n°4 pcs)
 - ⊖ 8-9-15-20-25 (n°5 pcs)
 - ☆ 3-4-5-6 (n°4 pcs)
 - ⊙ 1,5-2-3-4-5-6 (n°6 pcs)
 - + Square Adaptor 1/4" (6,35mm), n°1 pc

TECHNICAL DETAILS:

- Range..... 1~6 Nm
- Resolution 0.1 Nm
- Tolerance..... ±6%
- Length 195mm (7.7")
- Weight..... 335gr. (11.8oz)
- Automatic quick-release, audible and palpable click, when selected torque is reached
- Automatic reset after 90°
- Right-handed (CW)

TORQUE SUGGESTED*

THREAD	Nm
M2,5	1,0
M3	1,2
1/8"	1,4
M3,5	1,8
M4	2,7
M5	5,3

* Suggested tightening torque for CMT screws (Class 8.8)

APPLICATION:



The Adjustable Torque Screwdriver is versatile enough for use in many fields, but we recommend it for the tightening or fastening of CMT bits and cutters heads with interchangeable knives.



To download this user manual in a different language, visit www.cmtorangetools.com

DESCRIPTION	BOXES	ORDER NO.
Adjustable torque screwdriver set 1~6 Nm	24	TW-006

Interchangeable Torque Wrench 20~200 Nm

The Interchangeable Torque Wrench comes complete with a sturdy protective case to store and keep tools safe, an instruction manual, and calibration certification(unique for each instrument) according to DIN ISO 6789 & ASME B107.300-2010.

TW-200



Optional

- TW-2836** (ER16 & ER20)
- TW-4045** (ER25)
- TW-5055** (ER32)
- TW-5862** (ER40 & EOC25)
- TW-8001** (Kinetic Dust Extractor 992)
- TW-1001** (Kinetic Dust Extractor 992)
- TW-A912**
- TW-A095**
- TW-A127**

TECHNICAL DETAILS:

- Range..... 20~200 Nm (10-150 lbf-ft)
- Resolution 1 Nm
- Tolerance..... ±4%
- Length 500mm (19.7")
- Weight..... 1,15Kg. (40.6oz)
- Automatic quick-release, audible and palpable click, when selected torque is reached
- Right-handed (CW)

TORQUE SUGGESTED*

CHUCK/COLLET	Nm	Lbf-ft
ER16	57	42
ER20	80	59
ER25	104	77
ER32	135	100
ER40	176	130
EOC25	122	90

* Suggested tightening torque for CMT Chuck/Collet



To download this user manual in a different language, visit www.cmtorangetools.com

DESCRIPTION	S mm	BOXES	ORDER NO.
Interchangeable Torque Wrench 20~200 Nm	14x18	12	TW-200
Hook Head Insert Ø=28-36mm (ER16 & ER20)	14x18	1	TW-2836
Hook Head Insert Ø=40-45mm (ER25)	14x18	1	TW-4045
Hook Head Insert Ø=50-55mm (ER32)	14x18	1	TW-5055
Hook Head Insert Ø=58-62mm (ER40 & EOC25)	14x18	1	TW-5862
Hook Head Insert Ø=80mm (Kinetic Dust Extractor 992)	14x18	1	TW-8001
Hook Head Insert Ø=100mm (Kinetic Dust Extractor 992)	14x18	1	TW-1001
Push Ratchet Insert S2=3/8"	14x18	5	TW-A095
Push Ratchet Insert S2=1/2"	14x18	5	TW-A127
Adapter Insert S2=9x12mm	14x18	50	TW-A912

APPLICATION:



The Interchangeable Torque Wrench is versatile enough for use in many fields, but we recommend it for the tightening of CMT chucks.

Laminate/Veneered-Panel Cutter

A very useful hand tool for clean, splinter-free cuts on laminates and veneer with no waste. Place your material into the fence provided and run the cutter along the edge of the panel. The two opposing steel-made circular cutting blades mounted on roller bearings will trace the cutting line. Use the micrometer knob on the top of the tool to set the cutting thickness, or adjust the strip width by using the metric/inch scale provided. Loosen the lock knob on the scale, move the metal bracket which holds the fence and tighten the lock knob again on the desired cutting width.

DET-003



TECHNICAL FEATURES:

- Cutting width: 12~110mm (15/32" ~ 4-21/64")
- Cutting depth: 0~2mm (0 ~ 5/64")
- Weight: 1.2 kg (2.65 lbs).

DESCRIPTION	ORDER NO.
Laminate/Veneered-Panel Cutter	DET-003

Spare parts DET-003K Pair of cutters right-left for DET-003

Edge Banding Iron

Apply pre-glued edge banding easily and accurately. The iron non-stick surface allows smooth and easy application. The thermostatically controlled short preheat time gets you working quicker. Includes heat resistant metal base to place iron when not in use.

DET-004



TECHNICAL DETAILS:

- Voltage: 110-230V
- Electric current: 0.3A
- High temperature: 180° ±10° C

- Includes thermostatic heat control.
- Non-stick coating.
- Specially shaped shoe with rounded edges.
- Metal stand.
- 154cm (5-1/2') power cord, 230V.

DESCRIPTION	ORDER NO.
Edge Banding Iron	DET-004

Edge Banding End Trimmer

An indispensable tool for easy and safe end trimming after edge banding. Position the tool on the banding, press down on the handle to operate the blade in a shearing action. The cutting knives are interchangeable, so when the cutting knife becomes dull, you can simply replace it with the anvil knife for a double lifetime. For cutting banding up to 0,5mm thick with a maximum cutting width of 54mm. This tool can also be paired up with our double edge trimmer **DET-001**. We recommend using our edge banding end trimmer **DET-002** before using our double-edge trimmer **DET-001**.

DET-002

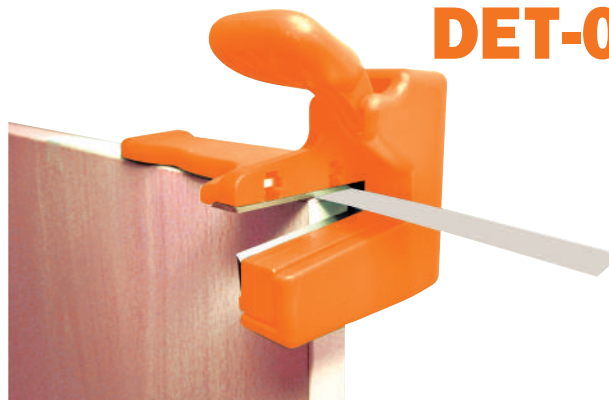

DESCRIPTION	ORDER NO.
Edge Banding End Trimmer	DET-002

Spare parts DET-002K 2-Pcs replacement blade set 55x13x1,5mm

Double-Edge Trimmer

Attach this trimmer to your workpiece, press both ends against the board for a cutting range between 13mm (1/2") and 25mm (1"), move the trimmer in the correct direction indicated by the arrow. This will cut on both sides easily. The first cutter will cut straight, the second one can be adjusted for a tapering cut. Both cutters are made from high-quality hardened steel and can be easily replaced when worn out.

DET-001



DESCRIPTION	ORDER NO.
Double-Edge Trimmer	DET-001

Spare parts DET-001K Spare knives for double-edge trimmer

Bowl & Tray System

BTS-002

CMT System **BTS-002** provides a fun and easy way for you to make divided bowls and trays in your shop. No lathe? No problem. This bowl making technique uses a router and CMT's unique bowl and tray router bit. The resulting bowls and trays are beautiful. This kit also provides an excellent way to use up scrap wood. Glue pieces together, butcher block style, to make a beautiful pattern of colors and species.

The templates will withstand a lifetime of use and can be used to make a variety of bowl or tray styles. The collet extension, used to make extra deep bowls, is also useful whenever your general woodworking requires extra deep cuts.



TMP-011
MDF Template



TMP-012
MDF Template



Trace the templates onto the bowl blank.



Rough out the interior using a drill press and a 50,8mm Forstner bit.



Rout the interior to final shape using the bowl and tray router bit and collet extension.



Bandsaw the exterior to final shape.



Watch the video on
YouTube

DESCRIPTION	ORDER NO. S=Ø12mm
Bowl & Tray System	BTS-002
<i>The kit includes</i>	
Router Bit	951.502.11B
Router Collet Extension	796.002.00
MDF Template nr. 1	TMP-011
MDF Template nr. 2	TMP-012
Instruction manual	

Optional



TMP-101
MDF Template
400x400mm.



TMP-103
MDF Template
400x400mm.



TMP-105
MDF Template
330x300mm.

Diamond Whetstones

For professional, industrial and home users

DSS

FAST: real quality diamond, the hardest known material, reduces the sharpening process.

EASY: stoke the blade across the surface with little pressure.

DURABLE: we use natural diamonds for long-lasting performance.

VERSATILE: for sharpening any hard material, steel, glass, ceramic, tungsten carbide, etc.



FOR SHARPENING, HONING AND LAPPING

- axes
- bayonets
- broadheads
- cable cutters
- carbide cutters
- chainsaws
- chisels
- climbing equipment
- engraving tools
- farm and garden tools
- fish hooks
- Forstner bits
- knives
- lapidary tools
- lawn mower blades
- masonry drills
- moulds and dies
- plane blades
- planer /jointer knives
- pruners

FOR ABRADING HARD MATERIALS

- ceramic
- composites
- fibreglass
- glass
- stainless steel
- stone
- titanium
- tool steel
- tungsten carbide

FOR FLATTENING

- chisel backs
- engine heads
- machine bolsters and ways

Watch the video on **YouTube**



Universal diamond whetstone in leather sheaths

DIMENSIONS	GRAIN mm	GRAIN	ORDER NO.
115 x 25 x 3	D15 extrafine	green	DSS-115E
115 x 25 x 3	D25 fine	red	DSS-115F
115 x 25 x 3	D46 coarse	blue	DSS-115M
115 x 25 x 3	D76 extracoarse	black	DSS-115G

Diamond whetstone file

DIMENSIONS	GRAIN mm	GRAIN	ORDER NO.
100 Ø4,8	D54 coarse	blu	DSS-048M

Universal diamond whetstones in hardwood case

DIMENSIONS	GRAIN mm	GRAIN	ORDER NO.
150 x 52 x 16	D15 extrafine	green	DSS-150E
150 x 52 x 16	D25 fine	red	DSS-150F
150 x 52 x 16	D46 coarse	blue	DSS-150M
150 x 52 x 16	D76 extracoarse	black	DSS-150G

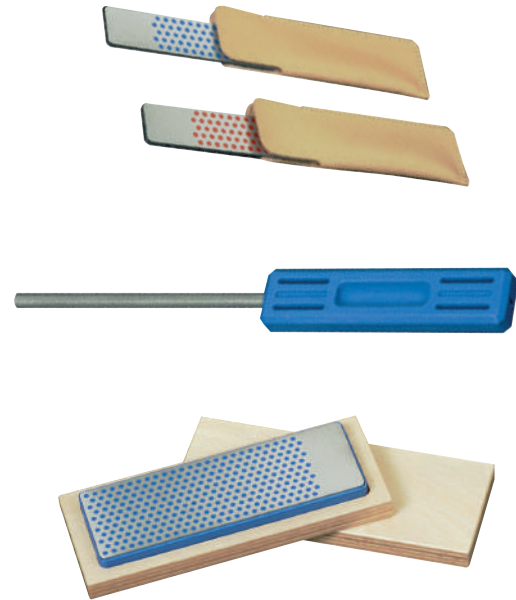

A unique production process to guarantee long tool life

A perforated steel plate is moulded onto a strong plastic base by applying high pressure. The steel is then covered with natural diamonds embedded into a nickel plate. The pattern and diamond coating ensures fast sharpening, whereas the plastic indents hold the lubricating water and disperse the fine dust emitted by the diamonds during sharpening.

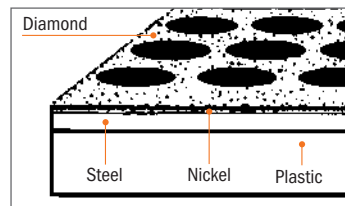

The diamond whetstones are available in four meshes for multiple purposes:

D15 EXTRAFINE/GREEN (9 microns, 1200 mesh)

To refine and polish sharp edges to razor sharp perfection. If you are new to sharpening or need your knife or tool edges as sharp as possible, this grain type is what you are looking for.

D25 FINE/RED (25 microns, 600 mesh)

To restore any slightly dull knife or tool edges to perfect sharpness. Professional chefs and gourmet cooks prefer using this grit grain, too. This product is perfect for the edge refinement process before micro-refinement and polishing.

D46 COARSE/BLUE (45 microns, 325 mesh)

To quickly restore dull and worn edges. Professionals who require faster cutting action and less edge refinement often use this medium grit grain.

D76 EXTRA-COARSE/BLACK (60 microns, 220 mesh)

Recommended for aggressive removal of metal and metallic residue on damaged tools or restore heavy-duty outdoor tools such as axes and lawn mower blades. This grit grain is commonly used as a first step for flattening the back of chisel and plane irons or for rapid stock removal from chipped or badly damaged edges.

Instructions

Use water for lubrication, after use, rinse and store dry.

1. Keep your knife with cutting edge away from you.

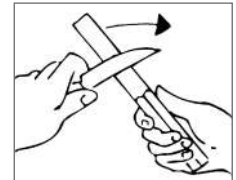

2. Apply some water to the stone surface. Hold blade 20° to diamond surface.

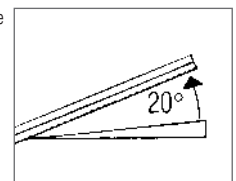

3. With little pressure and in long strokes push the blade across surface. From edge heel to edge tip, alternately on both sides. For pointed tools. Use the unperforated diamond area.

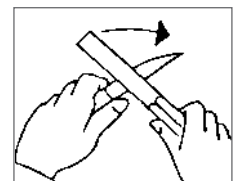

Latex Coated Gloves

new





CMT ORANGE TOOLS®

These protective gloves are not only comfortable but offer high elasticity, impressive grip as well as good resistance to abrasion, perforation and tears. CE Certified and Mechanical Hazards EN 388:2016 compliant (2132X). Available in three sizes!



GLA



DESCRIPTION		ORDER NO.
Latex coated gloves M (8)		25 GLA-08M
Latex coated gloves L (9)		25 GLA-09L
Latex coated gloves XL (10)		25 GLA-10XL

CMT Professional Tool Bag

- Top zipped design and wide opening for accessing tools easily.
- Sturdy material and hard rubber bottom are resistant to rough handling and protects the contents from hard falls.
- 6 interior pockets, 12 exterior pockets.
- Ideal for storing and transporting hand tools as well as other medium sized items & accessories.

Material: Polyester 600D with 3mm EPE foam
Dimensions: 400x200x250mm

BAG-001

DESCRIPTION		ORDER NO.
CMT Professional Tool Bag	12	BAG-001



5 rubber studs at bottom



Carpenter Pencil & Ink Pen

An easy-grip shape and larger rectangular surface area means this pencil won't roll away or slip from your hands. The non-round core makes highly legible thick or thin lines.

Perfect for high precision tracing and marking virtually any surface. Easy to erase.

Strong break-resistance lead center withstands rough handling as well as the rigours and extreme conditions of the construction environment.



PCL-1

DESCRIPTION		ORDER NO.
Carpenter Pencil	50	PCL-1
CMT Ink Pen	50	PCL-2

new



PCL-2

Deep Hole Mechanical Marker



- Tip length 45mm (05.7mm) for marking tight and hard to reach places.
- Push-feed button for automatic lead advancement with built-in sharpener.
- CMT refills O2.8mm insertable at tip or opposite end.
- Sturdy metal body and handy pocket clip.
- Marks a variety of surfaces, rough or smooth, dry, wet or dusty.
- CMT refills available in Graphite (2B) or Crayon (red & yellow), each marker includes one graphite lead.
- **Graphite** ideal for marking: Paper, Wood, Laminates, Masonry, Stone and Artificial Stone, Metals and Non-Ferrous Metals.
- **Crayon*** ideal for marking: Plastics, Ceramic, Glass, Paper, Wood, Laminates, Masonry, Stone and Artificial Stone, Metals and Non-Ferrous Metals.

*Colored leads are made of wax, which means they are softer and more fragile than graphite leads. Handle them with care.



& MANY OTHERS



PCL-3D

DESCRIPTION	ORDER NO.
Deep Hole Mechanical Marker (display)	PCL-3D
Set contains	
24 pcs. PCL-3 Deep Hole Mechanical Marker	
8 pcs. PCL-3B Graphite Refills Leads (6 pcs.)	
4 pcs. PCL-3C Graphite (2pcs.) & Crayon Refills Leads (2pcs. red + 2pcs. yellow)	



WARNING:
Avoid breakage!
To close after refilling, carefully align the four grooves inside of pen barrel and cap.



Align the 4 grooves

DESCRIPTION	Quantity	ORDER NO.
Graphite Refills Leads (6 pcs.)	20	PCL-3B
Graphite (2pcs.) & Crayon Refills Leads (2pcs. red + 2pcs. yellow)	20	PCL-3C

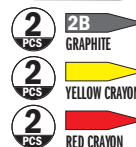

CMT ORANGE TOOLS™

CMT ORANGE TOOLS™

CMT

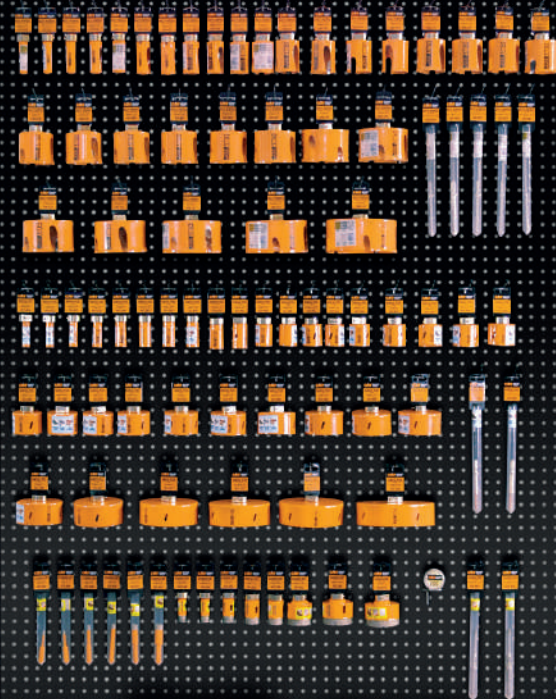

DISPLAY CABINETS

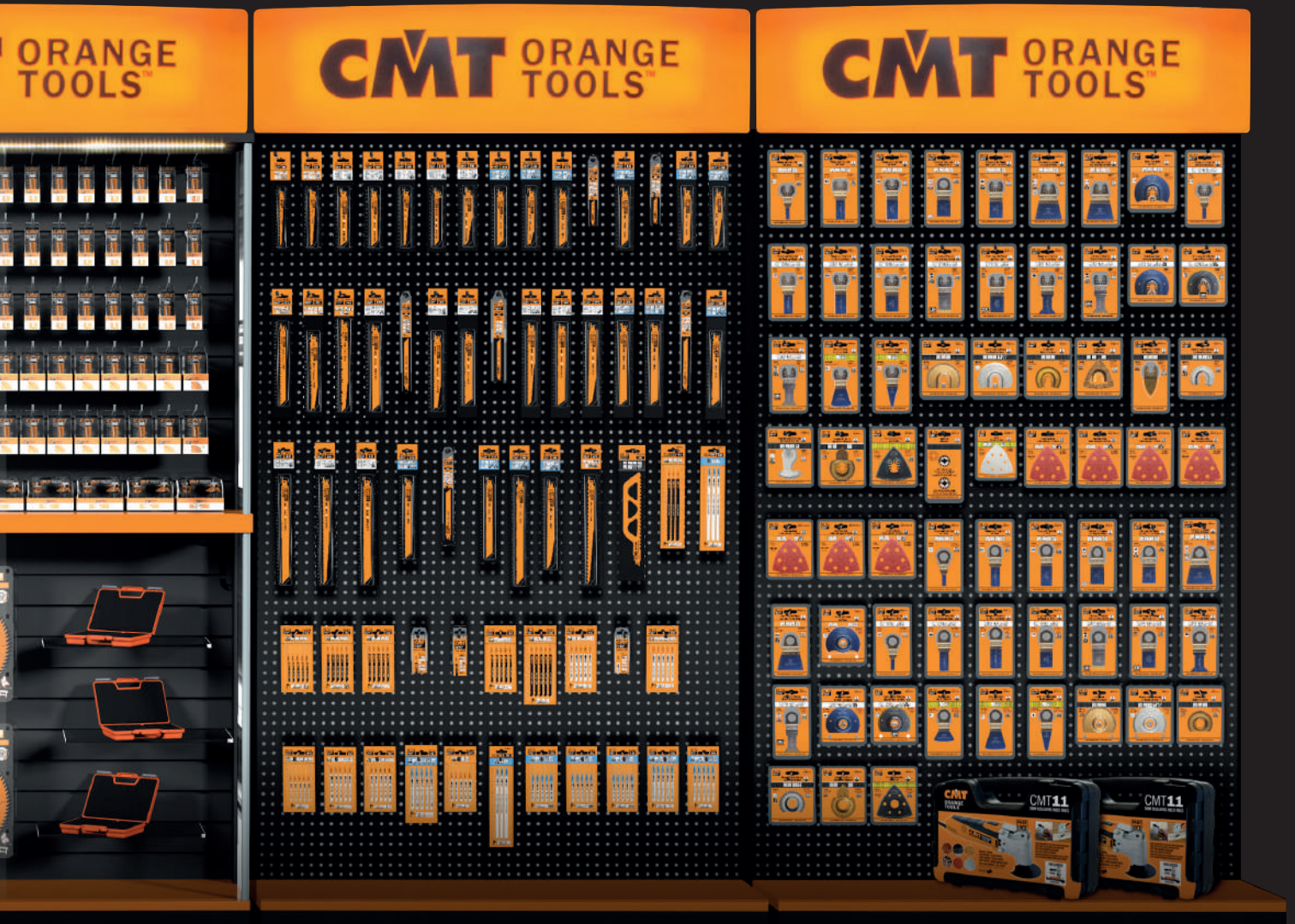

PRODUCTS	PAGE
Display Cabinets for Saw Blades	414
Display Cabinets for Sabre & Jig Saw Blades	415
Display Cabinets for Multi-Cutters	416
Display Cabinets for Router Bits	417
Display Cabinets for Router Bits & Forstner Bits	418
Display Cabinets for Hole Saws	419
Display Cabinets for Drill & Boring Bits	420
Multi Tools Mini Counter Display	421



Display Cabinets for Saw Blades

A sturdy steel saw blade display cabinet equipped with a backlight to place anywhere in your store. Hang and display a variety of different saw blades. Contact your CMT representative to seek advice on the most effective sawblade display composition for your needs. Tools not included. Dimensions in cm.

03.00.0038

SUITABLE FOR ALL BLADE TYPES

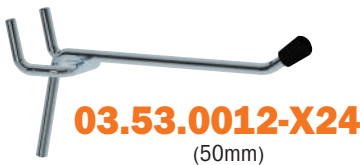
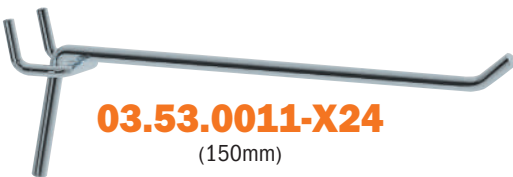
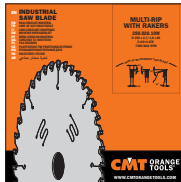

Image for information purposes only



Dimensions: 120 x 45 x 223cm

DISPLAYS THAT SELL!

DESCRIPTION	ORDER NO.
Display Cabinet with backlight (220V) for saw blades (blades and hooks not included - sold separately)	03.00.0038
Hooks 50mm. (24-pc pack)	03.53.0012-X24
Hooks 150mm. (24-pc pack)	03.53.0011-X24
Shelf (380x250x68mm.) for CMT display cabinet 03.00.0038 and 03.00.0045	03.53.0038
Lighted header sign CMT ORANGE TOOLS (220V) (<i>spare parts</i>)	03.54.0084
LED TUBE (220V) for sign display (<i>spare parts</i>)	03.54.0097

Display Cabinets for Sabre & Jig Saw Blades



A sturdy steel sabre and jig saw blade display cabinet equipped with a backlight to place anywhere in your store. You can hang and display a variety of different blades. Contact your CMT representative to seek advice on the most suitable blade display composition for your needs. Tools not included. Dimensions in cm.

IMBALLO143 Cardboard counter display for jig saw blades.

CMT's end cap cardboard display for jig saw blades takes advantage of the existing space in your store and is designed for countertops, existing shelves or free-space inside CMT display cabinets. Suitable for stocking up to 12 different jig saw blade types, 10 packs each, 120 packs in total. The end cap cardboard display helps increase product visibility and sell more!



DISPLAYS THAT SELL!

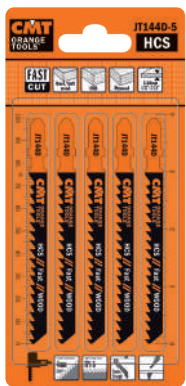

5-PIECE MASTERPACK

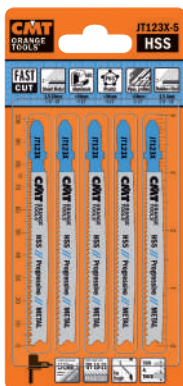

25-PIECE MASTERPACK



5-PIECE MASTERPACK



20-PIECE MASTERPACK



03.53.0020-X12 (50mm, for JS)



03.53.0012-X24 (50mm)

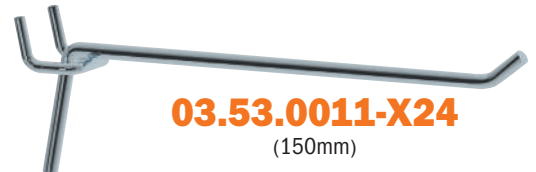

03.53.0011-X24 (150mm)

03.00.0038

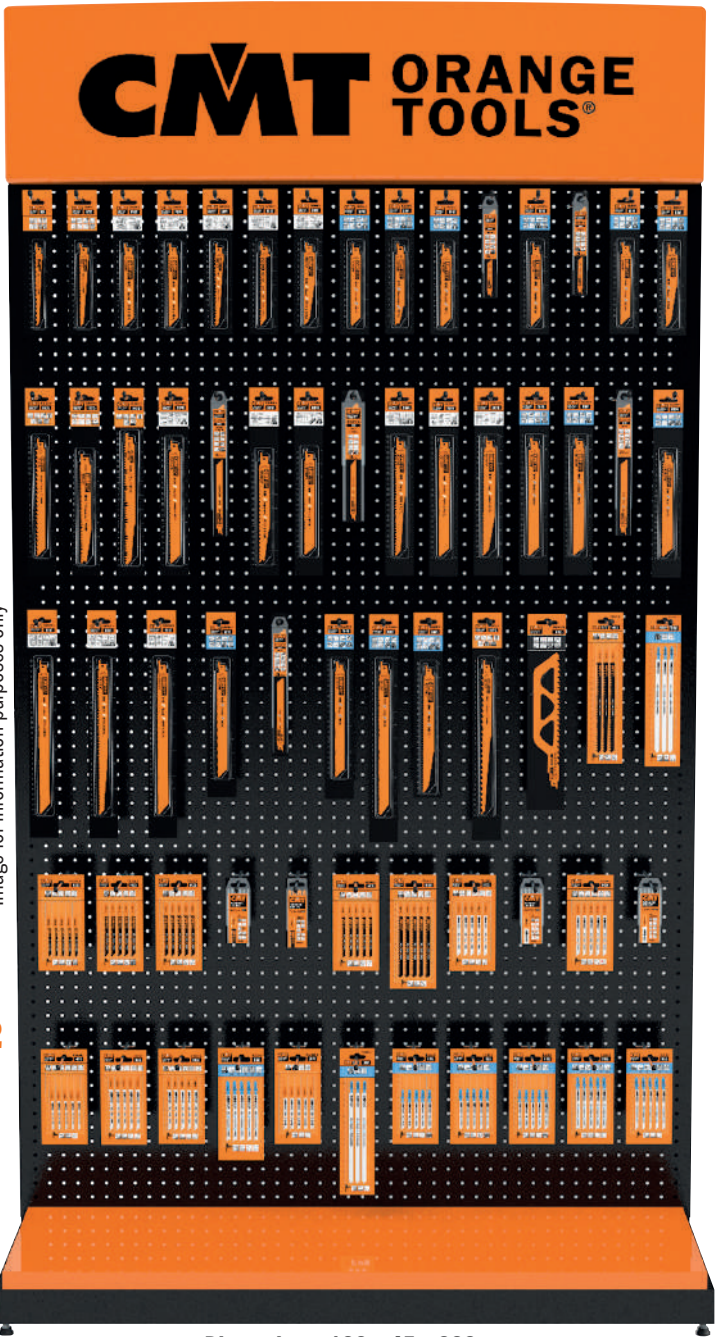

Image for information purposes only

Dimensions: 120 x 45 x 223cm

DESCRIPTION	ORDER NO.
Counter display only (blades not included)	IMBALLO143
Display cabinet with backlight (220V) for sabre and jig saw blades (blades and hooks not included - sold separately)	03.00.0038
Hooks 50mm. (24-pc pack)	03.53.0012-X24
Hooks 50mm. for JS (12-pc pack)	03.53.0020-X12
Hooks 150mm. (24-pc pack)	03.53.0011-X24
Shelf (380x250x68mm.) for CMT display cabinet 03.00.0038 and 03.00.0045	03.53.0038
Lighted header sign CMT ORANGE TOOLS 220V (spare parts)	03.54.0084
LED TUBE 220V for sign display (spare parts)	03.54.0097

Display Cabinet for Multi-Cutters

A sturdy steel multi-cutter display cabinet featuring an attractive backlight to place anywhere in your store. You can hang and display a variety of different cutters. Contact your CMT representative to seek advice on the most most effective cutter display composition for your needs. Tools not included. Dimensions in cm.

03.00.0038

WOOD



WOOD&METAL



MULTI-MAT



MASONRY



**1-PIECE CLAMSHELL
5-PIECE MASTERPACK**



03.53.0011-X24

(150mm)



03.53.0012-X24

(50mm)

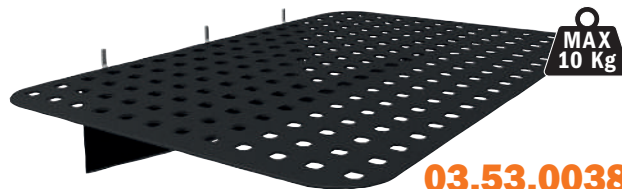

03.53.0038

Minimum order 2-pieces or multiple
For use with display cabinets 03.00.0038 and 03.00.0045

Image for information purposes only



Dimensions: 120 x 45 x 223cm

**DISPLAYS
THAT SELL!**

DESCRIPTION	ORDER NO.
Display cabinet with backlight (220V) for multi-cutters (tools and hooks not included- sold separately)	03.00.0038
Hooks 50mm. (24-pc pack)	03.53.0012-X24
Hooks 150mm. (24-pc pack)	03.53.0011-X24
Shelf (380x250x68mm.) for CMT display cabinet 03.00.0038 and 03.00.0045	03.53.0038
Lighted header sign CMT ORANGE TOOLS 220V (<i>spare parts</i>)	03.54.0084
LED TUBE 220 V for sign display (<i>spare parts</i>)	03.54.0097

Display Cabinet for Router Bits



This sturdy piece is hand-crafted from MDF, tempered glass and iron. The cabinet is free-standing and provides 360° visibility thereby allowing you to position the display anywhere in your store. The front is a convenient 2 component assembly. The upper section is designed to display 141 of the best selling router bits from the CMT router bit line as well as 20 corresponding spare parts. The lower section can perfectly fit 10 of the most popular boxed sets or saw blades, if required. Glass doors are secured with key lock.

03.00.0042



Deluxe packaging
recloseable and reusable



03.53.0012-X24
(50mm)



03.53.0042-X24
(150mm)



03.53.0017
Tool Shelf (270x209x1,5mm)
Display cabinet accomodates up to 40 shelves.

Image for information purposes only



Dimensions: 120 x 45 x 223cm

DESCRIPTION	ORDER NO.
Display cabinets complete with: 240 HW router bits (S=Ø6mm), 66 spare parts (your choice of saw blades) and hooks	700.300.00L
Display cabinets complete with: 240 HW router bits (S=Ø8mm), 66 spare parts (your choice of saw blades) and hooks	900.300.00L
21 pcs. HW router bits with shank Ø12mm for our display cabinet (optional)	900.021.00
Display cabinet for router bits and cutter heads (tools and hooks not included- sold separately)	03.00.0042
Hooks 50mm. (24-pc pack)	03.53.0012-X24
Hooks 150mm. (24-pc pack)	03.53.0042-X24
Tool shelf (270x209x1,5mm.) for CMT display cabinet 03.00.0042 (tools not included - sold separately)	03.53.0017
LED TUBE 220V for sign display (spare parts)	03.54.0097
Set of 2 pieces of 220V LED STRIPS for display cabinet (spare parts)	03.54.0089
Set of 2 metal supports (RH-LH) for light header sign (spare parts)	03.53.0109
Lighted header sign CMT ORANGE TOOLS 220V (spare parts)	03.54.0084

Display Cabinet for Router Bits & Forstner Bits

A beautiful, well-organized display of router bits in your shop is the best way to encourage customers to buy. CMT has produced this beautiful cabinet to best show off our wide selection of high quality bright orange bits, Forstner bits and boring bits. Made with a sturdy MDF frame and three glass panels, it is the ideal counter-top display. The wooden slat back wall allows for easy bit organization and comes standard with front door lock. Glass door secured with key lock.

03.00.0002



03.00.0002



Display for Boring & Forstner Bits

Image for information purposes only



*Deluxe packaging
recloseable and reusable*



Clamshell packaging



03.53.0042-X24
(150mm)



03.53.0012-X24
(50mm)

**DISPLAYS
THAT SELL!**

DESCRIPTION	ORDER NO.
Display cabinet with: 76 HW Router bits (S=Ø6mm), 8 spare parts (2 pcs. each)	700.084.00
Display cabinet with: 76 HW Router bits (S=Ø8mm), 8 spare parts (2 pcs. each)	900.084.00
Display cabinet for Router / Forstner bits (Tools & Hooks not included- sold separately)	03.00.0002
Hooks 50mm. (24-pc pack)	03.53.0012-X24
Hooks 150mm. (24-pc pack)	03.53.0042-X24

Display Cabinet for Hole Saws



A sturdy steel hole saw display cabinet complete with a backlight to place anywhere in your store. You can hang a variety of different types of hole saws. Contact your CMT representative to seek advice on the best hole saw display composition for your needs. Tools not included. Dimensions in cm.

ZERO LIMITS!
FAST^{X4} HOLE SAWS CAN TACKLE EVEN
 THE TOUGHEST MATERIALS!

SERIES 550 TUNGSTEN CARBIDE-TIPPED
SERIES 553 TUNGSTEN CARBIDE-TIPPED LONG



10X
LONGER LIFE
5X
FASTER

SERIES 551 BI-METAL PLUS 8% COBALT



2X
LONGER LIFE

SERIES 552 DIAMOND DRY

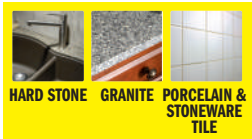

10X
LONGER LIFE

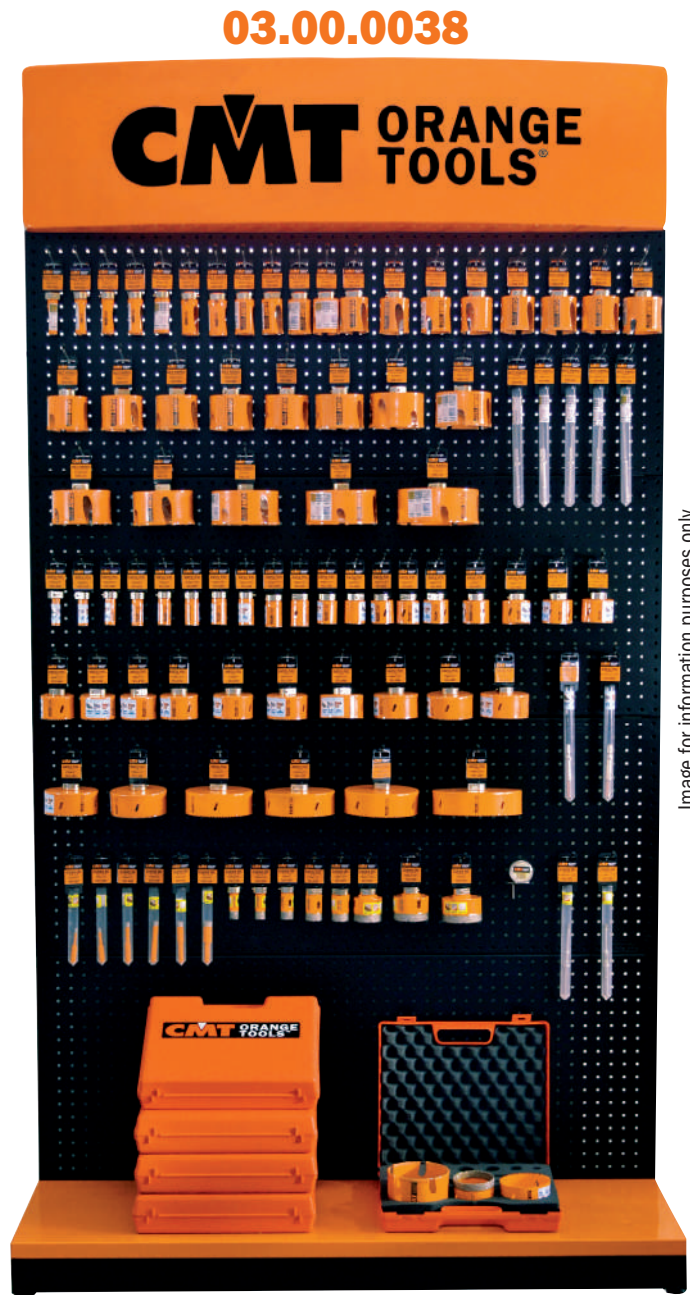
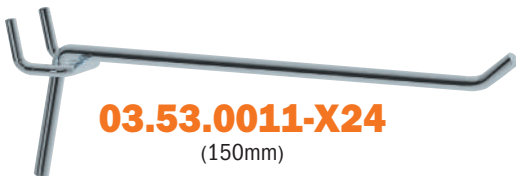

Image for information purposes only

Dimensions: 120 x 45 x 223cm



03.53.0013-X24
(200mm)



03.53.0011-X24
(150mm)

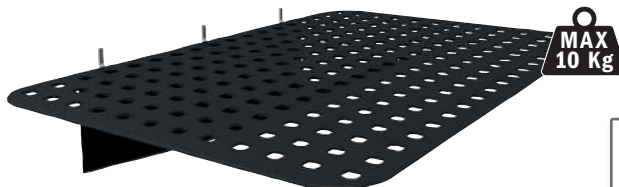

03.53.0038
 Minimum order 2-pieces or multiple
 For use with display cabinets **03.00.0038** and **03.00.0045**

**DISPLAYS
 THAT SELL!**

DESCRIPTION	ORDER NO.
Display cabinet with backlight (220V) (Hole Saws & Hooks not included, sold separately)	03.00.0038
Hooks 150mm. (24-pc pack)	03.53.0011-X24
Hooks 200mm. (24-pc pack)	03.53.0013-X24
Shelf (380x250x68mm.) for CMT display cabinet 03.00.0038 and 03.00.0045	03.53.0038
Illuminated Header Sign CMT ORANGE TOOLS 220V (<i>spare parts</i>)	03.54.0084
LED TUBE 220V for Header Sign (<i>spare parts</i>)	03.54.0097

Display Cabinet for Drill & Boring Bits

03.00.0042

Build up your stock of CMT Drill and Boring bits now by ordering this convenient display case! Get organized and keep your tools within reach and visible!

Contact your CMT representative for information and get the best advice on choosing the right selection of drill bits for your display from our very broad range. Tools not included. Dimensions in cm.

- **Fit Top Selling 120 SKUs.**
- **Fit up to 20 Deep**
- **Secured Glass with Key Lock**

X-TREME BORING BITS



Image for information purposes only



03.53.0017

Steel shelf for Drill & Boring bits.
Fit up to 40 shelves into one 03.00.0042 display case.
Fastening screw to secure bits on shelf: 990.010.00

Dimensions: 270 x 209 x 1,5mm



Dimensions:
120 x 31 x 223cm

DISPLAYS THAT SELL!

DESCRIPTION	ORDER NO.
Display Cabinet for Drill and Boring Bits (Shelves, Bits & Screws not included- sold separately)	03.00.0042
Tool Shelf (270x209x1,5mm) for Display Cabinet 03.00.0042 (Bits & Screws not included - sold separately)	03.53.0017
LED TUBE 220V for Header Sign (<i>spare parts</i>)	03.54.0097
220V LED STRIPS (2 pcs set) for Display Cabinet (<i>spare parts</i>)	03.54.0089
Set of 2 Metal Supports (RH-LH) for Header Sign (<i>spare parts</i>)	03.53.0109
Illuminated Header Sign CMT ORANGE TOOLS 220V (<i>spare parts</i>)	03.54.0084

Multi Tools Mini Counter Display



This simple yet attractive counter display will definitely increase sales because it improves visibility. This cabinet shows off a variety of tools: jig saw blades, sabre saw blades, oscillating tools, router bits, Forstner bits, drill bits and hole saws. That's the best way to attract and encourage customers to buy! A sturdy steel body featuring our trademark orange colour makes for an ideal eye-catching counter-top display! Tools not included. Dimensions in cm.

SUITABLE FOR ALL CMT TOOLS!

03.00.0043

03.00.0045

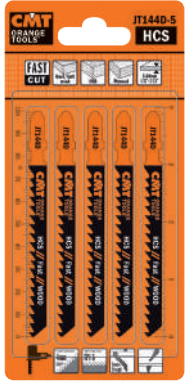

JIG SAW BLADES



SABRE SAW BLADES

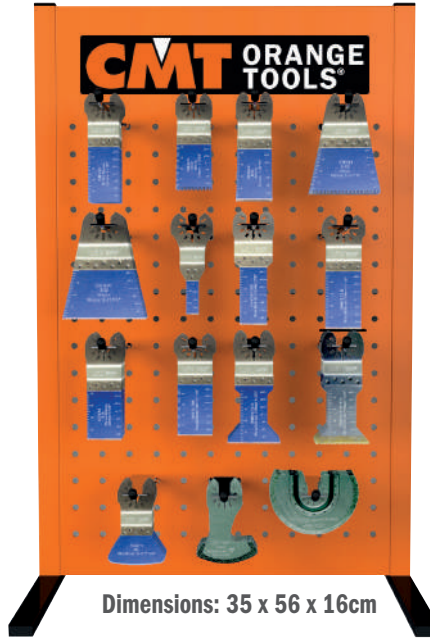

Dimensions: 35 x 56 x 16cm

new

Image for information purposes only

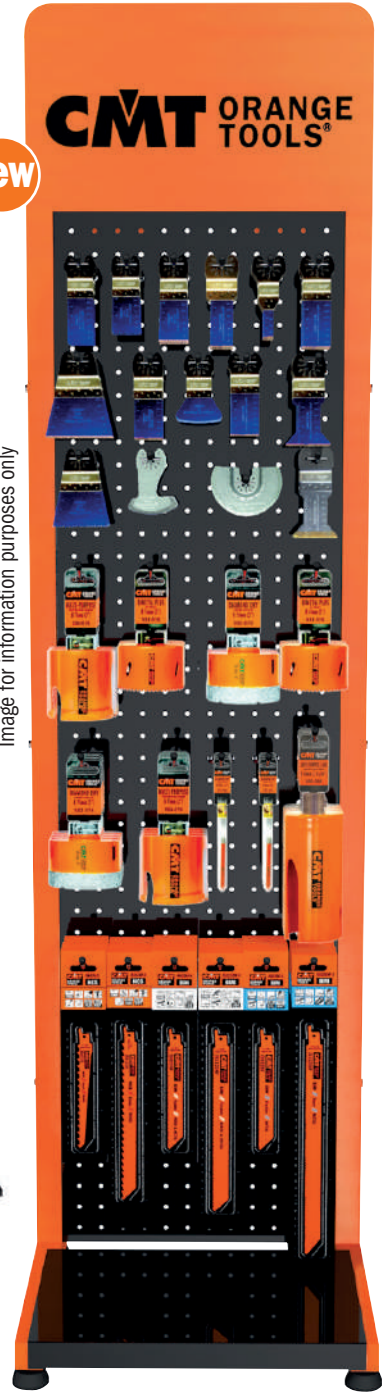

Dimensions: 38 x 145 x 35cm



OSCILLATING TOOLS



ROUTER BITS

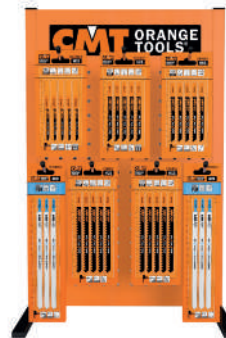

FORSTNER BITS



HOLE SAWS

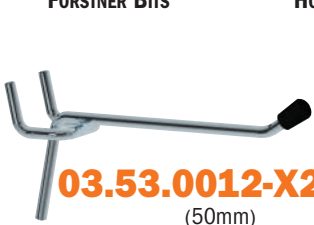
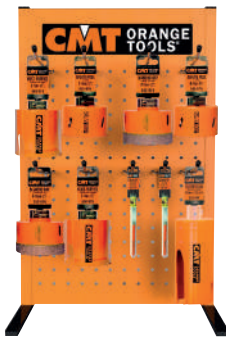

03.53.0012-X24
(50mm)

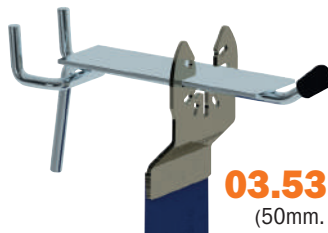

03.53.0014-X12
(50mm. for OMM & OMS)



03.53.0020-X12
(50mm. for JS)

DESCRIPTION	ORDER NO.
Mini-Counter Display (Tools & Hooks not included - sold separately)	03.00.0043
Medium-sized Display Cabinet (Tools & Hooks not included - sold separately)	03.00.0045
Hooks 50mm. (24-pc pack)	03.53.0012-X24
Hooks 50mm. for OMM & OMS (12-pc pack)	03.53.0014-X12
Hooks 50mm. for JS (12-pc pack)	03.53.0020-X12
Shelf (380x250x68mm.) for CMT display cabinet 03.00.0038 and 03.00.0045	03.53.0038

new

Bearings

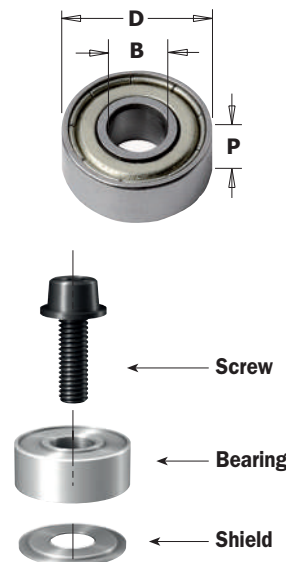

SAFETY RECOMMENDATIONS: be sure to keep the black washer right side up so that it corresponds with the bearing rotation during reassembly.

* After resharpener, always switch to an undersized bearing:
791.062.00 Ø9,3 replaces 791.002.00 (Ø9,5)
791.063.00 Ø12,5 replaces 791.003.00 (Ø12,7)

Sold in 10 pc. case.
 Minimum 10 pc. or multiple orders.

****** DELRIN® Cylindrical Bearings**

**** 10° DELRIN® Conical Bearings**

***** DELRIN® Triangular Bearings**

D		B		P	Box	ORDER NO.
mm	inches	mm	inches	mm		
6,35	1/4	3,17	1/8	2,8	10	791.035.00
9,3		4,76	3/16	3,17	10	791.062.00*
9,5	3/8	4,76	3/16	3,2	10	791.002.00
12,5		4,76	3/16	4,98	10	791.063.00*
12,7	1/2	4,76	3/16	5	10	791.003.00
12,7	1/2	6,35	1/4	4,8	10	791.010.00
13		5		4	10	791.022.00
13		6		5	10	791.023.00
15		6		5	10	791.024.00
15,8	5/8	4,76	3/16	5	10	791.018.00
15,8	5/8	6,35	1/4	5	10	791.009.00
16		5		5	10	791.006.00
16		8		5	10	791.025.00
19	3/4	4,76	3/16	7,5	10	791.019.00
19		6		6	10	791.007.00
19,05	3/4	6,35	1/4	7	10	791.004.00
19		8		6	10	791.034.00
19	3/4	12,7	1/2	4	10	791.011.00
22		8		6	10	791.012.00
22		8		7	10	791.005.00
22,2	7/8	4,76	3/16	7,5	10	791.017.00
22,2	7/8	9,52	3/8	7	10	791.021.00
22,2	7/8	12,7	1/2	7	10	791.013.00
24		8		8	10	791.036.00
28		8		9	10	791.037.00
28		12		8	10	791.026.00
28,5	1-1/8	4,76	3/16	8,4	10	791.014.00
28,5	1-1/8	8		8,5	10	791.030.00
28,5	1-1/8	12,7	1/2	8	10	791.027.00
31,7	1-1/4	8		5	10	791.033.00
31,7	1-1/4	12,7	1/2	8	10	791.015.00
34,9	1-3/8	4,76	3/16	11,5	10	791.016.00
34,9	1-3/8	8		11,6	10	791.031.00
34,9	1-3/8	12,7	1/2	11	10	791.029.00
37		12		12	10	791.028.00
38,1	1-1/2	12,7	1/2	13,3	10	791.020.00
62		30		16	10	791.051.00
62		35		14	1	791.052.00
80		40		18	1	791.054.00
80		50		16	1	791.053.00
DELRIN® Cylindrical Bearings						
12,7	1/2	4,76	3/16	5	10	791.044.00****
15,87	5/8	4,76	3/16	7,2	10	791.045.00****
19,05	3/4	4,76	3/16	6,8	10	791.046.00****
25,4	1	4,76	3/16	6,8	10	791.049.00****
37,4		12,7	1/2	15,7	10	791.047.00****
10° DELRIN® Conical Bearings						
19	3/4	4,76	3/16	6,8	10	791.041.00**
22	7/8	4,76	3/16	6,8	10	791.048.00**
DELRIN® Triangular Bearings						
12,7	1/2	4,76	3/16	5,8	10	791.042.00***
19	3/4	4,76	3/16	6,8	10	791.043.00***

Shields for Bearings

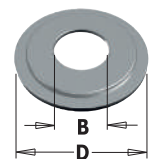



new

new

B	D	Box	ORDER NO.
mm	mm		
4,76	9,5	10	990.422.00
4,76	12,7	10	990.423.00
6,35	19	10	990.425.00
12,7	34,9	10	990.426.00

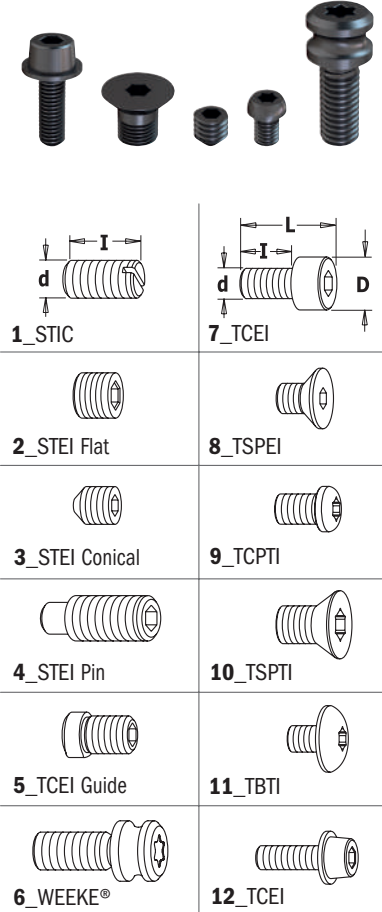

Screws

990

		d x l x L mm	D mm	TYPE		ORDER NO.	d x l x L mm	D mm	TYPE		ORDER NO.
1_STIC	7_TCEI	M5x8		1	10	990.008.00	M6x25x31	10	7	10	990.098.00
2_STEI Flat	8_TSPEI	M5x10		1	10	990.003.00	M8x25x33	13	7	10	990.099.00
3_STEI Conical	9_TCPTI	M2x2		2	10	990.060.00	1/8"x1/2"x5/8"	5,5	7	10	990.059.00
4_STEI Pin	10_TSPTI	M4x4		2	10	990.016.00	M5x10x15	8,5	7	10	990.010.00
5_TCEI Guide	11_TBTI	M4x20		2	10	990.091.00	M4x4x6	8	8	10	990.004.00
6_WEEKE®	12_TCEI	M5x4		2	10	990.015.00	M5x9x12	9,8	8	10	990.055.00
		M5x5		2	10	990.001.00	M5x5x8	9	8	10	990.067.00
		M5x5 p/coppa		2	10	990.006.00	M6x8x10	8,8	8	10	990.083.00
		M3x3		3	10	990.005.00	M6x8,7x12	12	8	10	990.116.00
		M5x5		3	10	990.002.00	1/4"-20x7/8"	12	8	10	990.097.00
		M6x6		3	10	990.007.00	1/8"x3/8"x1/2"	7	12	10	990.058.00
		M4x3		3	10	990.013.00	M5x11,5x17	8 T20	6	10	990.088.00
		M4x4		3	10	990.014.00	M3x4x5,7	4,5 T8	9	10	990.082.00
		M6x5		3	10	990.009.00	M2,5x3x4,5	3,5 T8	10	10	990.070.00
		M6x8		4	10	990.087.00	M2,5x4,5x6	3,7 T8	10	10	990.071.00
		M6x10		4	10	990.106.00	M4x2x3,2	6 T9	10	10	990.079.00
		M6x16		4	10	990.066.00	M5x3,6x6,1	8,8 T25	10	10	990.080.00
		M6x20		4	10	990.084.00	M5x5x8	9 T25	10	10	990.093.00
		M6x25		4	10	990.085.00	M5x13x18	6,8 T15	10	10	990.063.00
		M8x12		4	10	990.065.00	M3,5x3,5x6	6 T15	11	10	990.072.00
		M8x16		4	10	990.064.00	M3,5x4,8x6,8 6	6 T15	11	10	990.115.00
		M8x20		4	10	990.086.00	M4x5,5x8	7,4 T20	11	10	990.094.00
		M5x5x9	6	5	10	990.068.00	M3,5x5x7,2	9 T15	11	10	990.073.00
		M2,5x6x8,5	4,5	7	10	990.062.00	M3,5x6x8,5	7 T15	11	10	990.077.00
		M3x6x9	5,5	7	10	990.051.00	M4x3,5x5,7	9 T15	11	10	990.074.00
		M3x10x13	5,5	7	10	990.053.00	M4x4x6,2	6 T15	11	10	990.076.00
		M3x16x19	5,5	7	10	990.054.00	M4x4x6,2	8,8 T15	11	10	990.056.00
		M4x6x10	7	7	10	990.052.00	M4x6x8	6 T15	11	10	990.078.00
		M4x12x16	7	7	10	990.061.00	M4x6x8,2	9 T15	11	10	990.075.00

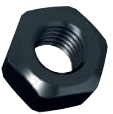

Nuts for Arbors

990.0

	DESCRIPTION		ORDER NO.	DESCRIPTION		ORDER NO.
	M4	10	990.092.00	M8	10	990.020.00
	M6	10	990.095.00	M12x1,25mm	10	990.022.00

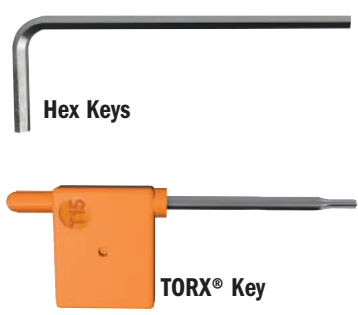

Keys for Screws

991

	DESCRIPTION		ORDER NO.	DESCRIPTION		ORDER NO.
Hex Keys	Hex Keys			6mm	10	991.066.00
TORX® Key	TORX® Key			TORX® Key		
	0,9mm (pour vis M2)	10	991.055.00	T8	10	991.063.00
	1,5mm (pour vis M3)	10	991.056.00	T9	10	991.069.00
	2mm	10	991.060.00	T15	10	991.061.00
	3/32" (pour vis 1/8W)	10	991.057.00	T20	10	991.072.00
	2,5mm (pour vis M4)	10	991.062.00	T25	10	991.073.00
	3mm	10	991.067.00	T30	10	991.071.00
	4mm	10	991.064.00			
	5mm	10	991.065.00			

Stop Collars

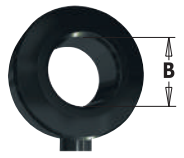
541

	B mm		ORDER NO.	B mm		ORDER NO.
	3,175	10	541.009.00	9,5	10	541.006.00
	6	10	541.003.00	12	10	541.005.00
	6,35	10	541.001.00	12,7	10	541.002.00
	8	10	541.004.00			

Arbors

797

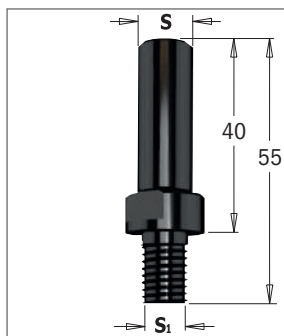

S mm	S ₁ mm			ORDER NO.
8	M10x1,5		10	797.580.00
10	M12x1		10	797.100.00
12	M12x1		10	797.120.00
12,7	M12x1		10	797.127.00

TECHNICAL DETAILS:
 - Super strength steel.
 - Precisely machined for accuracy.

Collet Chucks

796

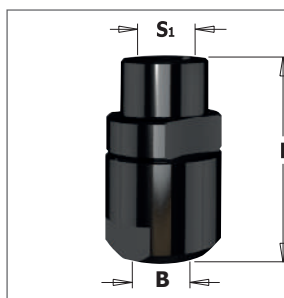

S ₁ mm	B mm	L mm			ORDER NO.
M10x1,5	6 - 6,35 - 8 - 9,5	38		10	796.100.00
M12x1	6 - 6,35 - 8 - 9,5	38		10	796.000.00
M12x1	10 - 12 - 12,7	47		10	796.121.00

TECHNICAL DETAILS:
 - Super strength steel.
 - Precisely machined for accuracy.

Collet not included.

Router Chuck Extensions with Collet

796.001/002

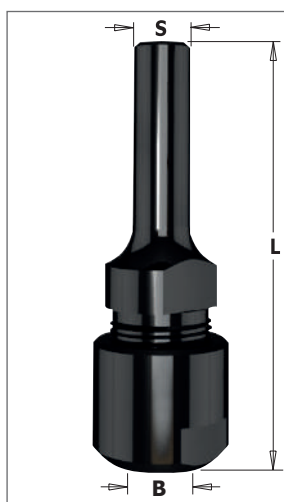

S mm	COLLET INCLUDED mm	FOR COLLETS mm	L mm			ORDER NO.
12	8	6 - 6,35 - 8 - 9,5	81		10	796.002.01
12	12	10 - 12 - 12,7	88		10	796.002.00
12,7	6,35	6 - 6,35 - 8 - 9,5	81		10	796.001.01
12,7	12,7	10 - 12 - 12,7	88		10	796.001.00

TECHNICAL DETAILS:
 - Super strength steel.
 - Precisely machined for accuracy.

Collet included.

Collet Chucks

796

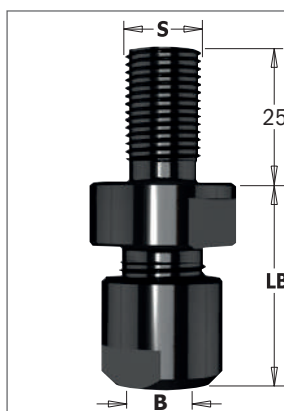

S mm	FOR COLLETS mm	LB mm			ORDER NO.
M14x2	6 - 6,35 - 8 - 9,5	32		10	796.140.00
M14x2	10 - 12 - 12,7	38		10	796.141.00
M16x2	6 - 6,35 - 8 - 9,5	32		10	796.160.00
M16x2	10 - 12 - 12,7	38		10	796.161.00

TECHNICAL DETAILS:
 - Super strength steel.
 - Precisely machined for accuracy.

Collet not included.

Collets

796.500/600

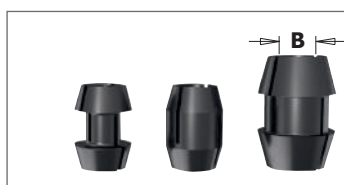

B mm		ORDER NO.	B mm		ORDER NO.
6	10	796.560.00	10	10	796.600.00
6,35	10	796.564.00	12	10	796.620.00
8	10	796.580.00	12,7	10	796.627.00
9,5	10	796.595.00			

new

Router Chuck Extension

796.003

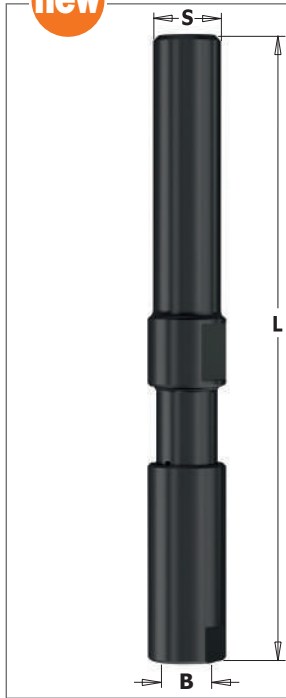

S mm	B mm	L mm		ORDER NO.
12	8	100	10	796.003.08

TECHNICAL DETAILS:

- High strength resistant steel.
- Precisely machined for accuracy.

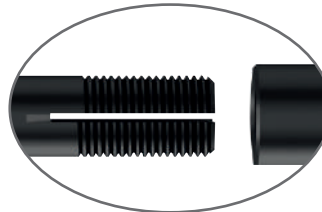

Collet not required

“ER20” Chucks

796

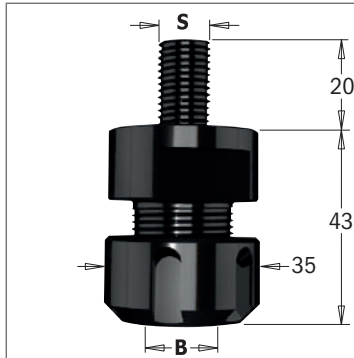

S mm	FOR COLLETS mm	LB mm		ORDER NO.
M12x1,75	3 ~ 12,7	43	10	796.122.00
M14x2	3 ~ 12,7	43	10	796.142.00
M16x2	3 ~ 12,7	43	10	796.162.00

Spare parts: 992.483.03 M25x1,5mm clamping nut
991.483.00 “ER20” key

TECHNICAL DETAILS:

- Super strength steel.
- Precisely machined for accuracy.

Collet not included.

SAFETY TIPS:

The **TW-200** Torque Wrench is recommended for the proper fastening of clamping nuts. (see page 406)

“ER20” Precision Collets for 796.122/142/162

184

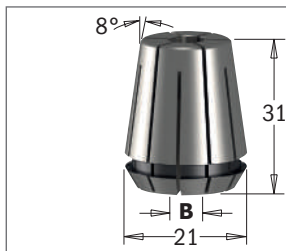

B mm		ORDER NO.	B mm		ORDER NO.
3	10	184.030.20	8	10	184.080.20
5	10	184.050.20	10	10	184.100.20
6	10	184.060.20	12	10	184.120.20
6,35	10	184.064.20	12,7	10	184.127.20

Collets for CMT1E, CMT2E, DEWALT®, FELISATTI®, FEIN®, METABO® Hand-Held Routers **796**

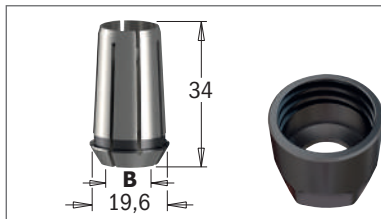

B mm		ORDER NO.	B mm		ORDER NO.
6	10	796.860.00	10	10	796.900.00
6,35	10	796.864.00	12	10	796.920.00
8	10	796.880.00	12,7	10	796.927.00
9,5	10	796.895.00			

Spare parts: 992.100.01 M22 Clamping nut

Collets for FREUD®/CASALS® Hand-Held Routers

796.780

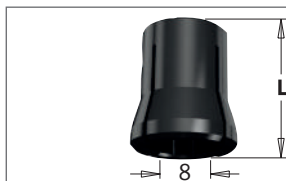

B mm	L mm		ORDER NO.
8	14	10	796.780.00

Bushings

799

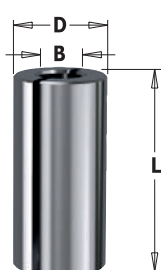

B mm	D mm	L mm			ORDER NO.
6	8	25		10	799.060.00
6	9,5	25		10	799.160.00
6	12	25		10	799.260.00
6,35	8	25		10	799.064.00
6,35	9,5	25		10	799.164.00
6,35	12,7	25		10	799.264.00
8	9,5	25		10	799.180.00
8	10	25		10	799.280.00
8	12	25		10	799.380.00
8	12,7	25		10	799.480.00
9,5	12,7	25		10	799.001.00
10	12	25		10	799.100.00
13	16	45		10	799.130.00

Arbors

798

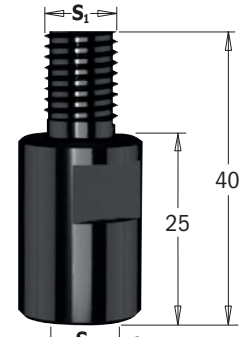



S mm	S ₁ mm			ORDER NO.
M10x1,5	M10x1,5		10	798.101.00
M10x1,5	M12x1		10	798.102.00
M12x1	M10x1,5		10	798.121.00
M12x1	M12x1		10	798.122.00

TECHNICAL DETAILS:
 - Super strength steel.
 - Precisely machined for accuracy.

Slot Cutter Arbors

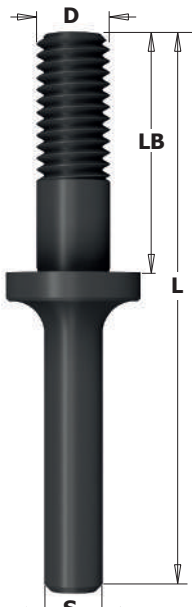
7/8/924



D mm	LB mm	L mm		ORDER NO. S=Ø6mm	ORDER NO. S=Ø6,35mm	ORDER NO. S=Ø8mm	ORDER NO. S=Ø12mm	ORDER NO. S=Ø12,7mm
Arbors for 822 Slot Cutters								
M8	23	71	10				924.133.00	824.133.00
M8	26	61	10	724.060.00	824.064.00	924.080.00		
M8	26	67,5	10				924.120.00	824.127.00
M8	29,75	71	10				924.131.00	824.131.00
M8	35,5	71	10				924.132.00	824.132.00
M8	40	81	10				924.128.00	824.128.00
M8	40	86	10			924.083.00		
M8	41	85	10				924.136.00	824.136.00
M8	47	97	10				924.130.00	824.130.00
M8	57	100	10				924.137.00	824.137.00
M12	39,5	85	10				924.134.00	824.134.00
M12	54	97	10				924.129.00	824.129.00
M12	54,5	100	10				924.135.00	824.135.00

Slot Cutter Arbors

7/8/924

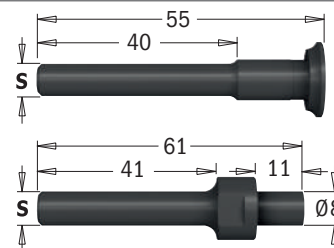



D mm	LB mm	L mm		ORDER NO. S=Ø6mm	ORDER NO. S=Ø6,35mm	ORDER NO. S=Ø8mm	ORDER NO. S=Ø12,7mm
Arbors for 823 Slot Cutters with Counterbore							
		55	10	724.061.00	824.061.00	924.081.00	824.121.00
8	11	61	10	724.062.00		924.082.00	824.122.00

Shields for Assembly

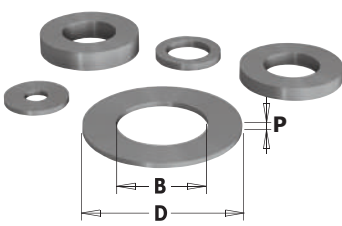
541



B mm	D mm	P mm		ORDER NO.	B mm	D mm	P mm		ORDER NO.
3,25	9	1,6	10	541.550.00	8	14,7	5,8	10	541.519.00
3,25	15,8	2	10	541.552.00	12	20	2	10	541.512.00
5,2	15,8	2,5	10	541.551.00	12	20	3	10	541.511.00
6,4	9,52	2,2	10	541.514.00	12	18	0,1	10	541.526.00
8	14	0,1	10	541.515.00	12	21	0,3	10	541.520.00
8	14	0,3	10	541.516.00	12	21	1,59	10	541.521.00
8	14	0,5	10	541.517.00	12	21	3,18	10	541.522.00
8	14	1	10	541.518.00	12	21	6,16	10	541.523.00
8	14,7	3	10	541.500.00	12	21	1	10	541.524.00
8	14,7	4	10	541.501.00	12	21	0,5	10	541.525.00

Spacers Set

695.998

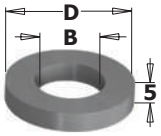
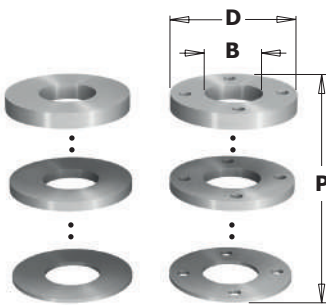



D mm	B mm	P mm	FOR CUTTER HEAD		ORDER NO.
Spacer ring					
30	60	5	694.021 - 694.022	1	299.560.30
31,75	60	5	694.021 - 694.022	1	299.560.31
35	60	5	694.021 - 694.022	1	299.560.35
40	60	5	694.021 - 694.022	1	299.560.40
50	70	5	694.021 - 694.022	1	299.570.50
Spacer sets					
50	30	9	694.015	10	695.998.01
50	31,75	9	694.015	10	695.998.02
55	35	9	694.015	10	695.998.03
60	40	9	694.015	10	695.998.04
70	50	9	694.015	10	695.998.05
50	30	33	694.005	10	695.998.11
50	31,75	33	694.005	10	695.998.12
55	35	33	694.005	10	695.998.13
60	40	33	694.005	10	695.998.14
70	50	22	694.005	10	695.998.15
Spacer sets with Pin Hole					
65	30	8	694.001 & 694.015	10	695.998.21
65	31,75	8	694.001 & 694.015	10	695.998.22
65	35	8	694.001 & 694.015	10	695.998.23
70	40	8	694.001 & 694.015	10	695.998.24N
70	50	8	694.001 & 694.015	10	695.998.25N

Threaded Rings for 694.001 Cutter Heads

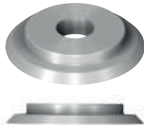
695.996





DESCRIPTION		ORDER NO.
M4 (Ø10x1,6mm)	10	695.996.01
M4 (Ø12x1,7mm)	10	695.996.02

Wedges for Cutter Heads

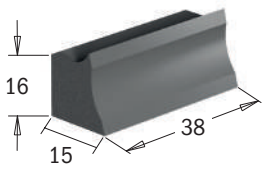
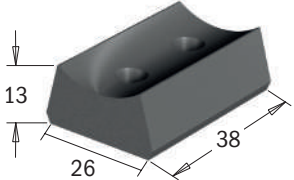
651-692-693-695

DESCRIPTION		ORDER NO.	DESCRIPTION		ORDER NO.
Wedge for Cutter Heads					
38x15x16mm	10	692.999.01	31x11x9,5mm	10	695.999.31
38x22,5x13mm	10	692.999.02	38x11x9,5mm	10	695.999.38
38x26x13mm	10	693.999.01	39x11x9,5mm	10	695.999.39
38x28x12,5mm	10	693.999.02	42x11x9,5mm	10	695.999.42
38x15x16mm (for 695.018)	10	695.018.01	46x11x9,5mm	10	695.999.46
7x11x9,5mm	10	695.999.07	49x11x9,5mm	10	695.999.49
16x11x9,5mm	10	695.999.16	53x11x9,5mm	10	695.999.53
17x11x9,5mm	10	695.999.17	Wedges for Router Bits with Knives		
22x11x9,5mm	10	695.999.22	D=8x20mm	10	651.999.01
23x11x9,5mm	10	695.999.23	D=10-12-12,7x30mm	10	651.999.02
23x11x9,5mm	10	695.999.24	D=12-12,7x50mm	10	651.999.03

Numerical Index

ORDER NO.	PAGE	ORDER NO.	PAGE	ORDER NO.	PAGE	ORDER NO.	PAGE	ORDER NO.	PAGE
01.02	322	183.000	275	227	52-53	308	331	365	326
03.00.0002	418	183.075	273	230.312	59	309	331	366	334
03.00.0038	414-416	183.100	275	230.5	58	310	328	367	335
03.00.0042	417, 420	183.200	274	235	47	310.21/22	322	368	335
03.00.0043	421	183.201	274	236	10	310.41/42	324	369	337-339
03.00.0045	421	183.210	274	237	46	311	329	369C	338
03.51	400	183.211	274	238	46	311.21/22	322	370	339
03.53.0011-X24	414-416, 419	183.220	274	240	60-62	311.41/42	324	372	332
03.53.0012-X24	414-418, 421	183.221	274	240.004.04	63	311.71/72	321	373	332
03.53.0013-X24	419	183.250	274	241	62	312	355	374	335
03.53.0014-X12	421	183.260	280	271	19, 23	313	334	375	335
03.53.0017	417, 420	183.300	273	272	27	313.41/42	325	376	333
03.53.0020-X12	415, 421	183.310	273	273	31	314	334	377	333
03.53.0038	416, 419	183.320	273	274	34	314.21/22	323	378	333
03.53.0042-X24	417-418	183.360	280	276	51	314.41/42	325	380	355
102	310	183.400	275	277	15	315	336	381	335
103	314	183.410	278	278	16	316	336	382	323
104	315	183.420	279	279	13	317	337-339	392	349
105	315	183.421	279	280	14	317C	338	500.001.08	351
106	316	183.422	279	281	38-39, 41-43	325	340	500.002.08	351
107	316	184	157, 276, 425	282	43	327	340	500.003.08	351
112	300	185	277	283	33	329	340	501	344
113	300	186	177	283.6	32	330	340	503	344
123	275	188	177	284	48	332	342	506	344
124	275	189	177	285	17, 21-22, 24-26, 28-30	334	342	507	344
140	295	190	170, 282	285.5	35	336	342	509	344
141	294	190.04	289	285.6	20	337	342	511	344
142	296	190.41	170	286	11	338	340	512	345, 347
143	297	190.41	282	287	36-37	339	340	512.001.00	347
145	298	190B	188	288	45	340	340	512.001.01	345
151	293	191	171, 284	289	44	341	342	513	348
152	292	191.0	261	290	18	342	342	514	348
160	311	191.143	290	291	22	343	342	515	357, 360-361
161	311-312	191.163	290	292	26, 30	344	341	515A	359
163	312	191.635	184	293	17	346	341	516	357
164	313	191B	188	294	21, 25-26, 30	350	358	517	356
166	313	192	171, 285	295	25, 40	351	358	521	336, 360-361
167	313	192.0	261	296	49-50	352	341	521.001	358
170	176	192.41	171, 285	297	49-50	353	341	521A	359
171	176	192B	188	298	63	358	319	522	210
172	310	193	286	299	64, 125	359	319	523	210
173	176	194	286	299.10	64	360.001	319	529	350
174	172, 299	195	288, 290-291	299.11	64	360.101	320	531	353
175	301	195.143	290	300.023.01	306	360.201	320	532	344
176	301	195.163	290	300.025.01	306	360.301	320	533	344
177	172, 301	196	289	301	318	360.401	320	534	344
178	303	197	288	302	318	361	328	535	354
179	314	198	170, 283	303	318	362	329	537	352
180	176	199	217, 292	304	318	363.11/12	327	537.000.04	352
181	176	222	57	305	319	363.21/22	327	537.000.05	352
182	176	223	57	306	330	363.41/42	327	537.000.07	352
183	280	226	54-56	307	330	364	326	537.000.12	352

Numerical Index

ORDER NO.	PAGE	ORDER NO.	PAGE	ORDER NO.	PAGE	ORDER NO.	PAGE	ORDER NO.	PAGE
537.000.16	352	652B	183	702	181	754	230	800.623	228
540	354	653	179, 302	703	215	755	203	800.624	259
541	354, 359, 423, 427	654	179	704	215	758	213	800.625	259
542	354	655	179	705	215	759	227	800.626	197
542.100.51	370	656	183	706	186-187	760	227	800.626	197
543	349	657.1	189	707	185, 188	761	230	800.627	255
550	368-369	657.9	189	709	185	762	231	800.628	255
550-DB1	369	657B	190	710	185	763	220	801	180
550-EX1	369	658	215	711	174-175	764	220	801B	180
550-EX2	369	659	215	711.031	184	765	224	806	186-187
550-HS1	369	660	194	711B	182	765.1	225	806B	187, 190
550-HS2	369	660.9	193	712	173	765B	224	807	188-189
550-HS2XL	369	661.11	221	712.030	184	790	158, 162-163	809	185
550-HW1	369	661.41	221	712.040	184	791	422	811	174-175
550-HW2	369	662	291	712B	182	791.703.00	194	811B	182
550-HW2XL	369	663	303	713.001	184	79101	269	812	173, 298, 391
550-SDS1	369	663.1	305	714	217	792	160	812.032	184
550-SDS2	369	663.201	305	714B	217	793	159	812B	182
551	366-367	663.301	304	715	212	795	161	813	196
551-HS1	367	663.5	304	715B	212	796	157, 424-425	813.001	184
551-HS2	367	664	210	716	191	796.001	424	814	217-218
551-HS2XL	369	665	214	716.060	191	796.002	424	814B	217
552	371	690-691	144-157	716.061	191	796.003	425	815	212
552-0	372	692	141-142, 427	718	208-209	796.500	424	815B	212
552-001-05	372	693	141, 143, 427	718B	208-209	796.600	424	816	191
552-115	375	694.001	124	721	184	796.780	425	816.064	191
552-115	375	694.002	128	722A	198	797	424	818	208-209
552-5	373	694.003	130	724	199, 426	798	426	818B	208-209
552-501-06	373	694.004	131	724.xxx.00	198	799	426	821	184
552-508M	374	694.005	127	724.xxx.10	198	800.001	251	822	198
552-CS	375	694.007	132	727	220	800.503	252	822.023B	196
552-DD1	371	694.008	133	735	193	800.505	252	822.024B	196
552-DD2	371	694.009	134	735.001	194	800.506	197	822.033B	247
552-EX14	373	694.011	135	736	216	800.509	257	822.034	243
552-GUIDE	372	694.012	136	737	219	800.510	257	822A	198
552-M	374	694.013	137	738	222, 244	800.511	257	822B	198
552-WAX	371	694.014	140	739	221	800.512	258	823	199
552-WAX	372	694.015	138-139	740	226	800.513	258	823.001	260
553	370	694.017	129	741	226	800.514	258	823.371	243
553-CP2	370	694.018	129	742	185	800.515	256	823B	199
553-HW10	370	694.019	126	743	185	800.516	258	824	199, 426
600.005.01	261	694.020	123	744	226	800.517	258	824.xxx.00	198
615.004.01	308-309	694.021	125	745	226	800.518	258	824.xxx.10	198
615.200D	308	694.022	125	746	227	800.520	256	827	220
615.350C	308	694.100	122	747	227	800.521	258	835	193
615.500B	308	695	427	748	225	800.522	258	835.001	194
615.620A	308	695.996	427	748B	225	800.524	256	835.503	192
616.000.01	307	695.998	427	749	211	800.525	253	835.990	192
616.120	307	699	157	750.0	195	800.527	254	836	216
616.200	307	700.005.03	260	751	211	800.606	206	837	219
651	178, 427	701	180	751B	211	800.616	206	838	222, 244
652	178, 391	701B	180	753	191	800.622	228	839	221

ORDER NO.	PAGE	ORDER NO.	PAGE	ORDER NO.	PAGE	ORDER NO.	PAGE	ORDER NO.	PAGE
840	226	861.6	229	900.514	258	935.990	192	961	230
841	226	862	231	900.516	258	936	216	961.6	229
842	185	863	220	900.517	258	937	219	963	220
843	185	864	220	900.518	258	938	222-223, 244	964	220
844	226	865	224	900.521	258	939	221	965	214, 224
845	226	865.1	225	900.522	258	940	226	965.1	225
846	227	865.9	223	900.527	254	941	226	965.9	223
847	227	865B	224	900.606	206	944	226	965B	224
848	225	866.501	246	900.616	206	945	226	966.501	246
848B	225	866.601	245	900.622	228	946	227	966.601	245
849	211	866.602	245	900.623	228	947	227	966.602	245
849B	211	867.5B	234	900.624	259	948	225	967.001B	234
850.0	195	867.6B	234	900.625	259	948B	225	967.101B	234
850.1	195	867.701	233	900.627	255	949	211	967.5B	234
850.5	195	868	218	900.628	255	949B	211	967.6B	234
850.6	195	870	242	901	180	950.0	195	967.701	233
851	211	880.5	244	901B	180	950.1	195	968	218
851B	211	880.511	249	902	181	950.5	195	970	242
852	181	880.512	249	903	215	950.6	195	980.5	244
852B	181	880.513	249	904	215	951	211	980.511	249
853	191	880.521	244	905	215	951B	211	980.512	249
854	230	880.531	248	906	186-187	953	191	980.513	249
855	200, 203, 235	880.541	245	906B	187, 190	954	229-230	980.521	244
855.3	204	880.542	245	907	185, 188-189	955	200, 203, 235	980.531	248
855.501	202	880.551	246	909	185	955.3	204	980.541	245
855.503	201	880.56	250	910	185	955.302	204	980.542	245
855.504	201	880.57	250	911	174-175	955.501	202	980.551	246
855.506	207	881.501	248	911B	182	955.503	201	980.56	250
855.510	207	881.511	249	912	172-173, 298, 391	955.504	201	980.57	250
855.604	234	881.512	249	912B	182	955.506	207	981.501	248
855.606	234	881.521	246	913	196	955.510	207	981.511	249
855.701	200	881.531	248	914	217	955.604	234	981.512	249
855.8	235	881.541	247	914B	217	955.606	234	981.521	246
855.801	204	890	240	915	212-213	955.701	200	981.531	248
855.802	204	890.5	241	915B	212	955.8	235	981.541	247
855.803	253	890.6	236	916	191	955.801	204	990	240, 422-423
855.806	255	891	237, 239	918	208-209	955.803	253	990.0	423
855.8B	235	891.517	237	921	184	955.806	255	990.088	320
855.901	233	891.521	239	922.033B	247	955.8B	235	990.5	241
855.902	233	899	395	922.034	243	955.901	233	990.6	236
856.501	233	900.001	251	922.035	243	955.902	233	991	237, 239, 423
856.601	236	900.003	251	922A	198	956.501	233	991.183	278
856.701	236	900.005.01	260	922B	198	956.601	236	991.184	278
856.702	236	900.005.03	260	923.001	260	956.701	236	991.283	278
856.8	232	900.024	256	923A	199	956.702	236	991.517	237
856.851	231	900.025	253	924	199, 426	956.8	232	991.521	239
856.852	231	900.506	197	924.xxx.00	198	956.851	231	992	272
857	216	900.509	257	924.xxx.10	198	956.852	231	992.183	277
858	213	900.510	257	927	220	957	216	992.283	277
859	227	900.511	257	935	193	958	213	992.383	277
860	227	900.512	258	935.001	194	959	227	992.583	277
861	230	900.513	258	935.503	192	960	227	993.0	278

ORDER NO.	PAGE	ORDER NO.	PAGE	ORDER NO.	PAGE	ORDER NO.	PAGE	ORDER NO.	PAGE
995	278	JS1141HM	93	JT301CD	79	OMF184	102	OMS01	112
998	401	JS1155CHM	90	JT313AW	81	OMF201	109	OMS02	112
999	384	JS1156XHM	90	JT318VF	79	OMF205	101	OMS03	112
999.100.11	383-384	JS1210VF	88	JT341HM	81	OMF208	102	OMS04	112
999.110.00	382	JS1211K	94	JT344D	78	OMF221	104	OMS05	113
999.500.00	383	JS1222VF	89	JT718BF	80	OMF222	103	OMS06	113
BAG-001	410	JS1225VF	91	JT744D	78	OMF223	104	OMS07	113
BBS-001	394	JS123XF	91	K CONTRACTOR®	12	OMF226	108	OMS08	114
BTS-002	408	JS1241HM	93	K174	263	OMF228	104	OMS09	114
CDG-001	403	JS1243HM	93	K900-005-01	269	OMF229	102	OMS10	114
CFC-002	403	JS1411DF	87	K900-005-02	269	OMF230	101	OMS11	114
CMT	380	JS1531L	86	K906	264	OMF232	101	OMS12	115
CMT-TGA	395	JS1617K	86	K911	263	OMF233	100	OMS13	115
CMT11	381	JS2243HM	93	K911B	264	OMF237	105	OMS14	115
CMT300	388-389	JS2345X	86	K912	263	OMF243	107	OMS15	116
CMT3000	390	JS3456XF	88	K914	264	OMF245	108	OMS16	116
CMT333	392-393	JS5678XF	88	K915	265	OMF251	109	OMS17	116
CMT333-325	394	JS610VF	87	K918	266	OMM-X33	120	OMS18	116
CMT334	394	JS611DF	87	K922	266	OMM-X37	120	OMS19	117
CMT650	391	JS617K	86	K927	267	OMM-X4	120	OMS20	117
CMT656	397	JS641HM	93	K935	267	OMM01	112	OMS21	117
CMT792	159	JS644D	86	K936	266	OMM02	112	OMS22	117
CMT7E	379	JS711DF	87	K937	267	OMM03	112	OMS23	118
CMT7E+IND	383	JS725VFR	88	K938	268	OMM04	112	OMS24	118
CMT7E+PRO	382	JS920CF	90	K940	268	OMM05	113	OMS27	118
CMT8E	378	JS922AF	92	K941	268	OMM06	113	OMS29	119
CMT900	396	JS922BF	92	K950	265	OMM07	113	OMS30	119
DAF-001	405	JS922EF	92	K955	269	OMM08	114	OMS35	115
DAG-001	405	JS922HF	89	K958	265	OMM09	114	OMS36	113
DET-001	407	JS922VF	89	K965	265	OMM10	114	PCL-1	410
DET-002	407	JS925VF	91	OMA30	110	OMM11	114	PCL-2	410
DET-003	407	JS955CHM	90	OMA30	119	OMM12	115	PCL-3D	411
DET-004	407	JS956XHM	90	OMA30000	110	OMM13	115	PGC	386
DHG-001	404	JT016	81	OMA30000	119	OMM14	115	PGD-1	387
DMM-001	404	JT101A0	78	OMA31	111	OMM15	116	PNL	257
DSS	409	JT101B	78	OMF-X4	109	OMM16	116	PPJ-002	385
GLA	410	JT101BIF	79	OMF001	107	OMM17	116	PTC-1	384
GLAS/RTBRN	253	JT101BR	78	OMF002	107	OMM18	116	RCS	398-400
IMBALLO143	415	JT101D	79	OMF106	99	OMM19	117	TMP	402
JS001	94	JT111C	77	OMF113	99	OMM20	117	TMP-R12	402
JS025	94	JT118A	80	OMF114	106	OMM21	117	TW-006	406
JS1025VF	91	JT118B	80	OMF118	106	OMM22	117	TW-200	406
JS1110VF	88	JT119B0	77	OMF125	106	OMM23	118		
JS1111DF	87	JT123X	80	OMF126	100	OMM24	118		
JS1111K	86	JT127D	80	OMF133	100	OMM25	119		
JS1120CF	91	JT141HM	81	OMF136	110	OMM26	118		
JS1122AF	92	JT144D	77	OMF157	105	OMM27	118		
JS1122BF	92	JT150RF	81	OMF160	103	OMM28	119		
JS1122EF	92	JT218A	80	OMF161	105	OMM29	119		
JS1122HF	89	JT234X	79	OMF165	108	OMM30	119		
JS1122VF	89	JT244D	77	OMF174	99	OMM35	115		
JS1125VF	91	JT244DDC	77	OMF183	103	OMM36	113		

Conversion Table



Inch Decimals	Inch Fractions (x)						Millimeters					
	1/64	1/32	1/16	1/8	1/4	1/2	mm	1" + (x)	2" + (x)	3" + (x)	4" + (x)	5" + (x)
0.015625	1/64						0.397	25.400	50.800	76.200	101.600	127.000
0.031250		1/32					0.794	25.797	51.197	76.597	101.997	127.397
0.046875	3/64						1.191	26.194	51.595	76.994	102.394	127.794
0.062500			1/16				1.588	26.591	51.991	77.391	102.791	128.191
0.078125	5/64						1.984	26.988	52.388	77.788	103.188	128.588
0.093750		3/32					2.381	27.384	52.784	78.184	103.584	128.984
0.109375	7/64						2.778	27.781	53.181	78.581	103.981	129.381
0.125000				1/8			3.175	28.178	53.578	78.978	104.378	129.778
0.140625	9/64						3.572	28.575	53.975	79.375	104.775	130.175
0.156250		5/32					3.969	28.972	54.372	79.772	105.172	130.572
0.171875	11/64						4.366	29.369	54.769	80.169	105.569	130.969
0.187500			3/16				4.762	29.766	55.166	80.568	105.966	131.366
0.203125	13/64						5.159	29.766	55.562	80.962	106.362	131.762
0.218750		7/32					5.556	30.162	55.959	81.359	106.759	132.159
0.234375	15/64						5.953	30.559	56.356	81.756	107.156	132.556
0.250000					1/4		6.350	30.956	56.753	82.153	107.553	132.953
0.265625	17/64						6.747	31.353	57.150	82.550	107.950	133.350
0.281250		9/32					7.144	31.750	57.547	82.947	108.347	133.747
0.296875	19/64						7.541	32.147	57.944	83.344	108.744	134.144
0.312500			5/16				7.938	32.544	58.341	83.741	109.141	134.541
0.328125	21/64						8.334	32.941	58.738	84.138	109.538	134.938
0.343750		11/32					8.731	33.338	59.134	84.534	109.934	135.334
0.359375	23/64						9.128	33.734	59.531	84.931	110.331	135.731
0.375000				3/8			9.526	34.131	59.928	85.328	110.728	136.128
0.390625	25/64						9.922	34.528	60.325	85.725	111.125	136.525
0.406250		13/32					10.319	34.925	60.722	86.122	111.522	136.922
0.421875	27/64						10.716	35.322	61.119	86.519	111.919	137.319
0.437500			7/16				11.112	35.719	61.516	86.916	112.316	137.716
0.453125	29/64						11.509	36.116	61.912	87.312	112.712	138.112
0.468750		15/32					11.906	36.512	62.309	87.709	113.109	138.509
0.484375	31/64						12.303	36.909	62.706	88.106	113.506	138.906
0.500000					1/2		12.700	37.306	63.103	88.503	113.903	139.303
0.515625	33/64						13.097	37.703	63.500	88.900	114.300	139.700
0.531250		17/32					13.494	38.100	63.897	89.297	114.697	140.097
0.546875	35/64						13.891	38.497	64.294	89.694	115.094	140.494
0.562500			9/16				14.288	38.894	64.691	90.091	115.491	140.891
0.578125	37/64						14.684	39.291	65.088	90.488	115.888	141.288
0.593750		19/32					15.081	39.688	65.484	90.884	116.284	141.684
0.609375	39/64						15.478	40.084	65.881	91.281	116.681	142.081
0.625000				5/8			15.875	40.481	66.278	91.678	117.078	142.478
0.640625	41/64						16.272	40.878	66.675	92.075	117.475	142.875
0.656250		21/32					16.669	41.275	67.072	92.472	117.872	143.272
0.671875	43/64						17.066	41.672	67.469	92.869	118.269	143.669
0.687500			11/16				17.462	42.069	67.866	93.266	118.666	144.066
0.703125	45/64						17.859	42.466	68.262	93.662	119.062	144.462
0.718750		23/32					18.256	42.862	68.659	94.059	119.459	144.859
0.734375	47/64						18.653	43.259	69.056	94.456	119.856	145.256
0.750000					3/4		19.050	43.656	69.453	94.855	120.253	145.653
0.765625	49/64						19.447	44.053	69.850	95.250	120.650	146.050
0.781250		25/32					19.844	44.450	70.247	95.647	121.047	146.447
0.796875	51/64						20.241	44.847	70.644	96.044	121.444	146.844
0.812500			13/16				20.638	45.244	71.041	96.441	121.841	147.241
0.828125	53/64						21.034	45.641	71.438	96.838	122.238	147.638
0.843750		27/32					21.431	46.038	71.834	97.234	122.634	148.034
0.859375	55/64						21.828	46.434	72.231	97.631	123.031	148.431
0.875000				7/8			22.225	46.831	72.628	98.028	123.428	148.828
0.890625	57/64						22.622	47.228	73.025	98.425	123.825	149.225
0.906250		29/32					23.019	47.625	73.422	98.822	124.222	149.622
0.921875	59/64						23.416	48.022	73.819	99.219	124.619	150.019
0.937500			15/16				23.812	48.419	74.216	99.616	125.016	150.416
0.953125	61/64						24.209	48.816	74.612	100.012	125.412	150.812
0.968750		31/32					24.606	49.212	75.009	100.409	125.809	151.209
0.984375	63/64						25.003	49.609	75.406	100.806	126.206	151.606
								50.000	75.803	101.203	126.603	152.003

Suggested Tools Rotation

Saw blade safety

- ALWAYS** thoroughly check all blades for damage and flaws before using. Do not use blades with missing or damaged teeth.
- ALWAYS** wear safety glasses and ear protection when using power tools.
- ALWAYS** thoroughly read the owners manual and manufacturer's instructions before working with tools.
- ALWAYS** secure the blade using flanges of the same diameter and of maximum diameter possible, but at least 1/3 of the blade diameter.
- ALWAYS** use a fence and splitter when using the table saw. Do not make freehand cuts.
- ALWAYS** use pusher blocks or a pusher stick, especially when working with small or narrow pieces.
- ALWAYS** unplug your saw before cleaning or adjusting the tool, or before making blade changes.
- ALWAYS** keep your tools sharpened, clean and stored in a safe place to avoid breakage and accidents and to extend the life of your bits and blades.
- ALWAYS** feed the workpiece against the rotation of the blade on table saws.
- ALWAYS** be sure your workpiece is completely supported, before and after the cut.
- NEVER** remove guards from radial arm saws and miter saws.
- NEVER** remove the splitter or anti-kickback devices from table saws.
- NEVER** use dull or damaged blades.
- NEVER** use blades with missing or chipped teeth.
- NEVER** force the cut or overload the saw.
- NEVER** change blades with the saw is plugged in.
- NEVER** make adjustments to any saw while the blade is rotating.

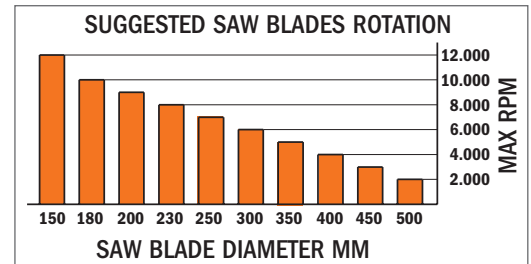

Cutter head safety

- ALWAYS** thoroughly check all cutters for damage and flaws before using.
- ALWAYS** wear safety glasses and ear protection when using power tools.
- ALWAYS** thoroughly read the owners manual and manufacturer's instructions before working with tools.
- ALWAYS** use guards that were supplied with your shaper.
- ALWAYS** use a fence with your shaper. Do not make freehand cuts.
- ALWAYS** use pusher blocks, especially when working with small or narrow pieces.
- ALWAYS** unplug your shaper before cleaning or adjusting the tool, or before making cutter or knife changes.
- ALWAYS** be sure the spindle nut is tight before plugging in the shaper.
- ALWAYS** check that knives are properly and securely installed in the cutterhead when using interchangeable-knife systems.
- ALWAYS** keep your tools sharpened, clean and stored in a safe place to avoid breakage and accidents and to extend the life of your bits and blades.
- ALWAYS** feed the workpiece against the rotation of the knives.
- ALWAYS** be sure your workpiece is completely supported, before and after the cut.
- NEVER** remove guards or any other safety devices from your shaper.
- NEVER** use dull or damaged knives.
- NEVER** force the cut or overload the shaper.
- NEVER** change cutters or knives or make adjustments with the shaper plugged in.
- NEVER** make adjustments to the shaper while the cutter is rotating.

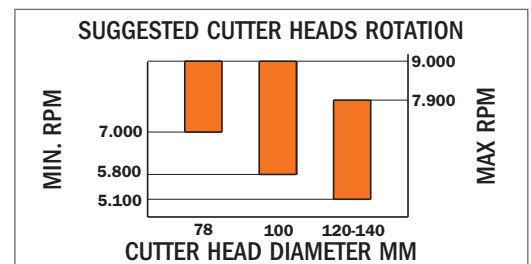

Router bits safety

- ALWAYS** thoroughly check all tools for possible flaws before using.
- ALWAYS** wear safety glasses and ear protection.
- ALWAYS** thoroughly read the owners manual and manufacturer instructions before using.
- ALWAYS** check that at least 75% of the shank is securely inserted into the collet of the router.
- ALWAYS** use template guide collars when possible to absorb lateral bit deflection.
- ALWAYS** use a fence when working on the router table.
- ALWAYS** reduce the router speed when working with larger diameter bits.
- ALWAYS** keep your fence adjusted so there is some clearance between the bearing guide and the workpiece.
- ALWAYS** take care to remove large quantities of stock (cross section > 10mm) in more than one run.
- ALWAYS** keep your tools sharpened, clean and stored in a safe place to avoid breakage and accidents and to extend the life of your bits and blades.
- NEVER** use dull or defective tools, even suspiciously defective.
- NEVER** force the shank entirely into the collet (bottoming out). Leave about a 3,2mm (1/8") space from the bottom.
- NEVER** force the bit into your router or overload the router.

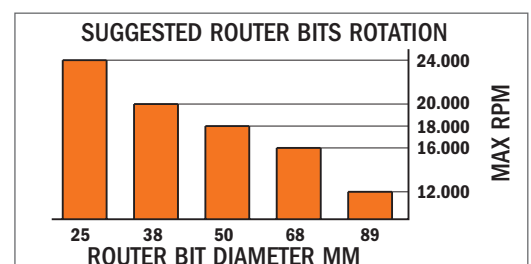

Explanation of Symbols

Tungsten Carbide Tipped	Solid Tungsten Carbide	Insert Carbide	Carbide Grit
Alloyed Tool Steel	High Speed Steel	High Performance Steel	High Carbon Steel
High-Alloyed Tool Steel	Heavy-Duty Steel 44 HRC	Bimetal with 8% Cobalt	Bimetal with 8% Cobalt + TiN Coated Teeth
Inox	Carbide TiN	Polycrystalline Diamond	Diamond Grit
One Cutting Edge	Two Cutting Edges	Three Cutting Edges	Three Cutting Edges with Chipbreaker
Four Cutting Edges	Six Cutting Edges	Twelve Cutting Edges	One + One Cutting Edges
Two + One Cutting Edges	Two + Two Cutting Edges	Three + Three Cutting Edges	Four + Four Cutting Edges
Six + Three Cutting Edges	One Spur	Two Spur	Four Spur
Right-hand Rotation	Left-hand Rotation	Right-hand & Left-hand Rotation	
Antikick-back	Radial Relief	Tool with Plunging Capacity	Tool with Bearing
Upcut Bit	Downcut Bit	Upcut & Downcut Bit	Axial Angle
Mechanical Feed	Manual Feed	Flush Trimming	Grooving, Sizing
Rebating, Profiling, Beveling	Slooting	Spiral Boring	Avoid Axial Plunging
Not for Hand Held use for Router Table only	Standard Precision Run-out 0.015	High Precision Run-out 0.005	Antikick-back
ORANGE CHROME®	Non-Stick Orange Shield Coating®	Nickel Coating	DLCS CHROME COATING
VAPO Heat Treatment	TiCN Coating	Saw Blade with Dampening Slots with Fill	Saw Blade with Dampening Slots without Fill
Cardboard Box for Saw Blades	Clamshell Carry Case for Saw Blades	Plastic Carry Case for Saw Blades	Plastic Box for Cutter Head
Long life	2X/4X Cutting Edge	20X/40X Longer Life Than Carbide	50X/60X Longer Life Than Carbide
Wear Five Finger Gloves	Wear Safety Glasses	Wear Ear Protection	Wear Dust Mask
Wear Safety Shoes	Wear Safety Helmet	Warning	

Conditions of trading

PREMISE C.M.T. products are the result of technological innovation achieved through continuous research applied on a vast scale. Drawings, technical data, photos of the products and packaging are supplied for the sole purpose of informing the customer and are not binding in any manner. **C.M.T.** may undertake, when necessary, modifications and improvements without applying these innovations to the parts already supplied. The operational tolerances conform to technical standards that are acceptable for this range of tools.

ACCEPTANCE OF THE CONTRACT All orders for our products are meant to be accepted at the price and sale conditions that are legally in force at the date of delivery.

Every order will be treated and supplied according to the following general sale conditions. By placing an order or accepting an offer, the customer accepts, without any reservations, all conditions expressly mentioned hereafter.

Any other derogation will only be accepted upon written consent by **C.M.T.** All other cases not contained within these conditions will fall under the Italian Civil Code.

Offers and order confirmations will be processed according to stock availability. Any order, even those taken by our representative agents, will be subject to our acceptance, which could also be a partial one.

We will notify the acceptance of any order by an order confirmation in which we will indicate all details pertaining to the items purchased, their price and expected delivery date. Therefore, we will not be able to accept any modification after three working days from the date of receipt.

MINIMUM AMOUNT ACCEPTABLE **C.M.T.** will only be able to accept and process orders for a minimum net amount of €100,00. In case of acceptance of the order, we will add €15,00 for shipping and handling.

PRICES The prices stated in **C.M.T.'s** quotation and price lists are gross and are intended to be "ex-works". Prices and VAT will be those in force at the date of shipping. To the best of our knowledge, the prices indicated in our catalogues, price lists and order confirmations are correct. However, **C.M.T.** cannot be held legally liable for reserving the right to change prices without notification in line with the manufacturer's cost increases.

DELIVERY Delivery dates in the order confirmation are given as an indication of the estimated delivery time. They have to be considered as reliable only in case of normal operating conditions, and there shall be no liability on the part of the Seller for any failure to deliver due to causes beyond the Seller's control. **C.M.T.** will also not be able to accept any cancellation of existing orders which were not delivered in time due to external impediments.

Standard products will be shipped within five working days from receipt of the order.

SHIPPING AND HANDLING The packing of our products will be charged on the final invoice, while shipping is "ex-works" from our factory at Chiusa di Ginestreto (Pesaro).

All products supplied by C.M.T. travel at the customer's own risk.

C.M.T. retains the right to charge freight costs on the invoice in case of value under the minimum amount acceptable of €100,00.

C.M.T. will not be held responsible for any damage, theft or tampering that might occur during transport, and for which the forwarder will be legally liable according to article 1693 of the Civil Code. The customer, for his part, will have to check the goods at the moment of receipt and, in case any anomaly or damage is found, he will have to apply for a refund to be addressed to the forwarder.

PAYMENT Cash payments can only be accepted for purchases done directly at the **C.M.T.** factory located in Chiusa di Ginestreto (Pesaro) in accordance with article 1182, sub-section 3 of the Civil Code, or upon delivery of the goods provided there is a written agreement between the parties.

Deferred methods of payment will have to be previously agreed with the Seller. In this case, if one or more instalments are not paid, the agreement will automatically expire according to article 1186 of the Civil Code.

A delay in payment, even partial, will automatically incur interest in the amount of an extra 5% to be charged to the customer's account.

In case of non payment, **C.M.T.** reserves the right to suspend any further supply of its products.

WARRANTY All professional tools by **C.M.T.** are manufactured according to high standards of technology and are therefore warranted against any possible defect. This warranty does not cover damage or tampering which can be ascribed to inappropriate use. It is also not applicable for tools that have been re-sharpened.

This warranty does not cover the possible injuries resulting from inappropriate use of defective tools.

C.M.T. will repair or replace any goods which the buyer shall prove to have been defective in material or workmanship upon analysis by its technical department. Any complaint must be communicated within fifteen days from receipt of the goods together with a written form in which the customer provides a detailed description of the defect. Any return of tools will only be accepted upon authorisation by **C.M.T.** and the freight will be at the customer's own expense.

CMT DEFECTIVE TOOLING OR SHIPPING ERROR RETURN POLICY CMT accepts the return of tools that are defective or have been shipped in error. All returned tools require proof of purchase, prior approval from a CMT Manager and a return authorization number, issued by C.M.T. UTENSILI SPA, PRIOR to returning.

10% restocking fee: If tooling is in like new condition (no damage to packaging or tooling, restrictions or other terms may apply).

Shipping: Returning dealer is responsible for all cost associated to shipping product back to CMT.

OWNERSHIP RIGHTS All rights are reserved in accordance with Italian law and with international agreements, and the whole or any part of this catalogue may not be reproduced in any way or form.

PLACE OF JURISDICTION For any legal matter the place of jurisdiction is Pesaro.

All contracts, even those made with foreign Buyers or for goods to be sent abroad, are regulated by Italian legislation.

© CMT, the CMT logo and the orange color applied to tool surfaces are trademarks of C.M.T. UTENSILI S.P.A.

© C.M.T. UTENSILI S.P.A.

Any other brand names mentioned in CMT product catalogues and on the CMT website are the property of their respective owners.

ADLER®	BUSELLATO®	DIVARIO®	FESTOOL®	HOFFMANN®	MAGGI®	OMLAT®	SCHER®	TORWEGGE®
AEG®	CAPTO®	DOMINO®	FLEX®	HOLZ-HER®	MAKITA®	OZITO®	SCHLEICHER®	TORX®
ALBERTI®	CASALS®	DREMEL®	FORMICA®	HOLZMA®	MASTERCRAFT®	P-SYSTEM®	SCM®	TRESPA®
ALTENDORF®	CERATIZIT®	DURALUMIN®	FOUNTAINHEAD®	HOMAG®	MASTERWOOD®	PALFOAM™	SILESTONE®	VECTURO®
ALUCOBOND®	CHICAGO®	DUROPLAST®	FREUD®	HPS®	MAYER®	PERLES®	SKIL®	VELCRO®
ANUBA®	CMS®	EIMA®	GIBRALTAR®	HUNDEGGER®	MEPLA®	PEUGEOT®	SMART®	VIRUTEX®
AVONITE®	CLAMEX®	EINHELL®	GRASS®	IMA®	METABO®	PLEXIGLASS®	STARLOCK®	VITAP®
AYEN®	CORIAN®	ELIJ®	GRIGGIO®	IVARPLANK®	MILWAUKEE®	POLYLAM®	STARLOCKMAX®	WEEKE®
BALESTRINI®	COROPLAST®	ETERNIT®	HÄFELE®	KNOEVENAGEL®	MORBIDELLI®	PORTER CABLE®	STARLOCKPLUS®	WEGOMAX®
BIESSE®	CRAFTSMAN®	ETHAFOAM®	HAFNER®	KRESS®	MULTIMASTER®	PROXON®	STAYER®	WILSONART®
BILEK®	CREMONESI®	FATIGUE-PROOF®	HARDIEPANEL®	LAMELLO®	MULTITALENT®	RIDGID®	STRIPLOX®	WOOD®
BISCO®	DELRIN®	FEIN®	HARDIEPLANK®	LEGNA®	NOTTMEYER®	ROCKWELL®	SURELL®	WORX®
BLACK & DECKER®	DENSIMET®	FELDER®	HETTICH®	LEUCO® P-SYSTEM	NUOVA BULLERI	ROTHENBERGER®	SWISSPEARL®	WÜRTH®
BLUM®	DEWALT®	FELISATTI®	HILTI®	LEXAN®	BREVETTI®	RYOBI®	TENSO®	ZETA P®
BOSCH®	DIBOND®	FERMACELL®	HITACHI®	MAFELL®	OKITE®	SALICE®	TERSA®	

This document has been sent for your personal use only.

All usage and reproduction is forbidden without written permission from C.M.T. UTENSILI S.P.A.

www.cmtorangetools.com



C.M.T. UTENSILI S.p.A.

Via della Meccanica, sn
61122 Pesaro (PU) - Italia

Tel. +39 0721 48571

Fax +39 0721 481021

info@cmtorangetools.com



Download this Catalogue



03.60.3006

18K0822